

UNIQUE VAST
OVER
70.000
ARTICLES
SELECTION

UNLIMITED
CRYSTAL
SOLUTIONS



*Since
1949*



2022

Welcome to the sparkling

world of Schöler Crystal

crystals for lighting & interior & decoration

your professional partner



Headquarters Austria

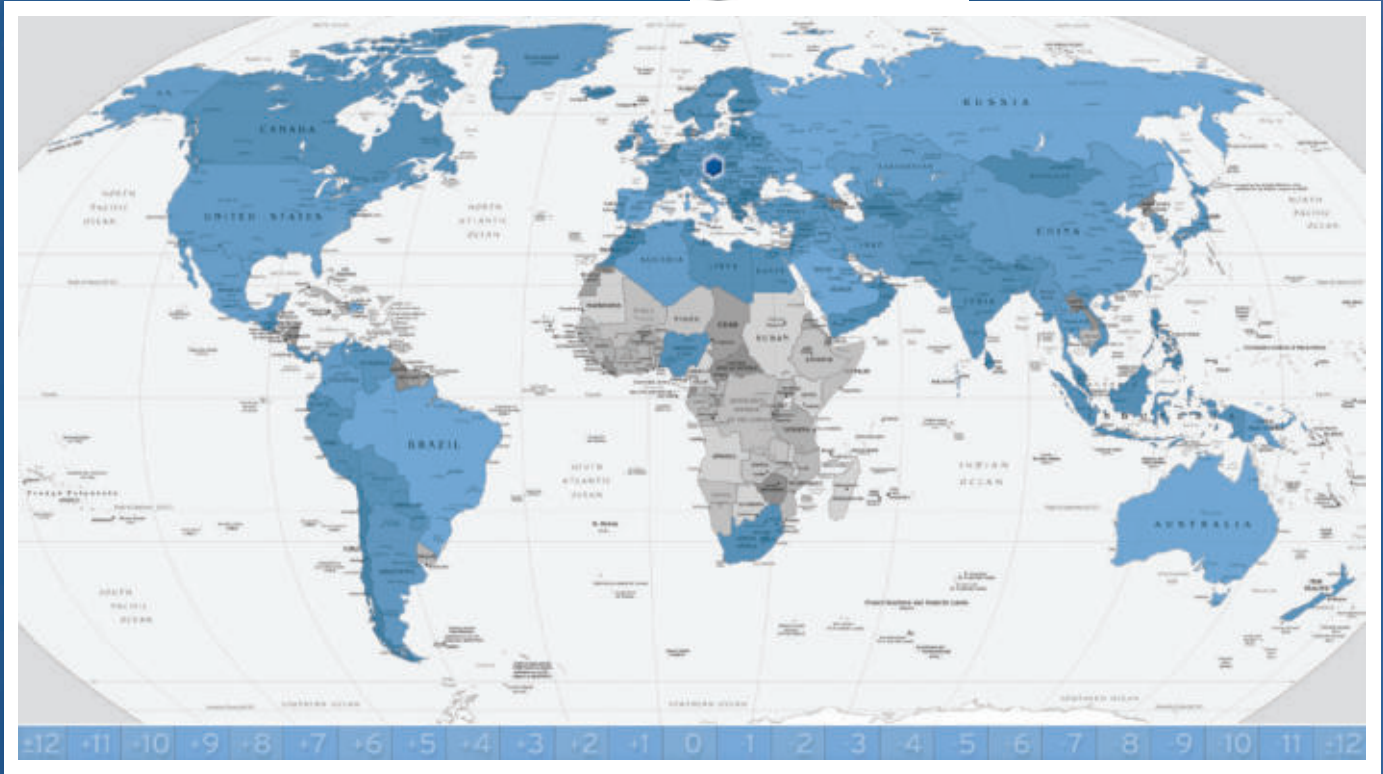

We supply to over 70 countries worldwide (blue color).



Art Collection



Calix of Duke Tassilo



Grave of the founder's son



Monastery Kremsmünster (Church)



Courtyard



Library

country



Monastery Kremsmünster

Foto: Tourismusverband Bad Hall - Kremsmünster

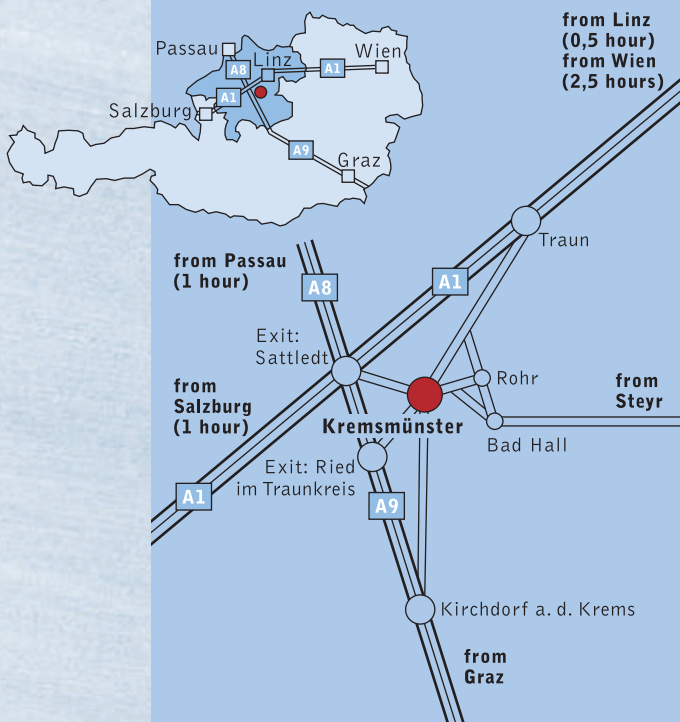

In Upper Austria, at the foothills of the Alps, is Kremsmünster ...

The "Monastery on the Krems" was founded in 777 by Duke Tassilo. It has remained, up to these days, a cultural and economical center of the region.

Although they continue to beware their traditions, the people here, at the crossings of old trade routes, are always open-minded towards anything new.

Here, it is possible to combine new ways with tradition.



Office Building



Showroom



Headquarters with factory I

**1949,
the company founders:
Alfred Kutnar
Kuno Schöler
Manfred Görner
Burkhard Görner**



First Production



company

Kremsmünster 1949

Centuries ago, when Bohemia was a part of the Austrian Monarchy, this region was the center of the glass industry, as it was rich with necessary natural resources. Post-war immigrants from Gablonz in Bohemia established the glass manufactory Schöler 1949 in Kremsmünster.

The people of Kremsmünster continued the production of glass and became internationally renowned suppliers of crystal components for decorative lighting for palaces, hotels, villas and representative buildings.

Our long-serving, motivated and qualified craftsmen represent the soul of our enterprise. They are the basis of our success from the very beginning. Our people played an essential part in making Schöler a leading producer of top quality chandelier crystals. Because of our highly trained employees, we continuously improve our world-market position.

**Today,
the company is managed by:
Christian Pamminger**



Kremsmünster today

Through consequent market surveys and responding to customer requirements, the enterprise Schöler is the leading complete-supplier to the industry.

Not only at the headquarters in Kremsmünster, but also through our worldwide representatives, we try our utmost to meet today's requirements through flexibility and quick shipping.



colors & coatings

| CRYSTAL | | COLORS | | COATINGS | | | |
|---------|--|-------------|--|-------------|-----------------|----|--|
| CLEAR | | ALEXANDRITE | | transparent | AB | | |
| FROSTED | | AMETHYST | | | AFLAME | | |
| | | AQUAMARINE | | | AMBER | | |
| | | EMERALD | | | ANTIQUE | | |
| | | JET | | | GOLD | | |
| | | ROSALIN | | | SILVER | | |
| | | RUBY | | | non-transparent | BB | |
| | | SAPPHIRE | | | | BW | |
| | | SMOKE | | | | OG | |
| | | TOPAZ | | | | OS | |
| | | | | VL | | | |
| | | | | VM | | | |



Hand-Production



1. melting

2. moulding

3. edging

4. cutting

5. polishing

6. quality-control

Machine-Production (semi- and full-automatic)

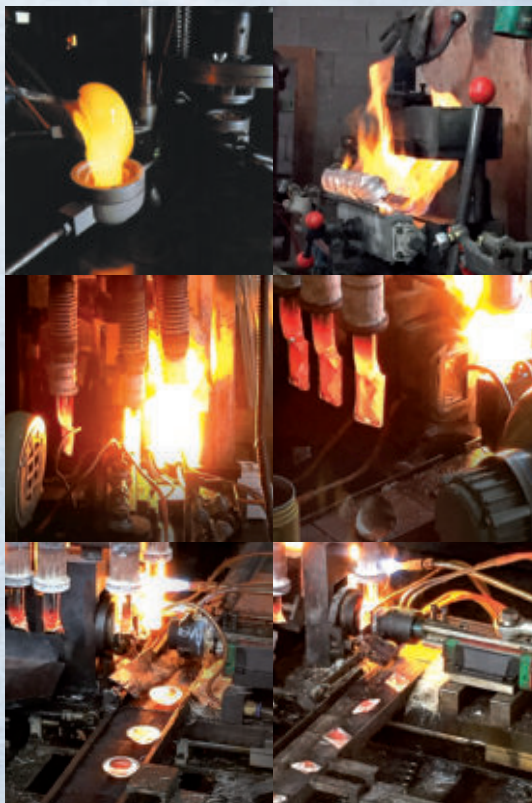

production

The raw material that we use mostly in our production is optical crystal: high quality glass with an excellent transparency and light refraction.

Hand production is a long labour-intensive procedure. Heated in the furnace, the clear or full-color raw material melts and turns into a viscous fluid. Then it is moulded under pressure in a metal mould. A semi-finished piece with the shape of the final product appears. Then it cools and hardens.

Now the product is cut by the master craftsman's hand. In many different steps, the facets and the edges will be cut until the incoming light separates into the spectral colors. Polishing adds the final brilliance.

Machine production is done by our highly precise cutting machines, using advanced technology, developed by Schöler.

On request, the finished crystal is coated with metal-oxides under vacuum to achieve a coating color.

At each production step, the quality is controlled. Finally, every single crystal is critically inspected.

The crystal products, quite often pinned together, are carefully packed and shipped to the customer.

In our comprehensive catalog, you will find everything, from economic products to the highest quality articles. We ensure that whichever type of crystal you select, only the best possible quality will be available.

Our range is extensive, but should your own designs be required, please don't hesitate to contact us accordingly. With pleasure, we will produce exclusively for you.



Certificate

The ÖQA-Austrian Society for the Promotion of Quality will award



Schöler & Co. GmbH
Gablonzer Straße 54-61, 4550 Kremsmünster
the



Austria Quality Seal



for following goods

**crystals for
lighting & interior & decoration**

Report No. BS 5298 / 11.11.2019
TGM Baustoffe u. Silikattechnik, Vienna

**Registration No. 33.031
Valid until 2022-12-31**

Vienna, December 2019/MP



Inspection Authority

ÖQA President

ÖQA General Manager

Quality Seal Ordinance
RGBl. 1942 I, S. 273

Notification from 11th July, 2002
by Federal Ministry for
Economic Affairs and Labour

Austrian Society for the Promotion of Quality





advantages

Product Advantages

- finest first quality
- carefully made using advanced technology
- the world's most extensive assortment of crystal components for decorative lighting: many thousand shapes and 10 colors and 12 coatings, in total over 70.000 articles
- permanent efforts in product development
- fair prices for all, from pressed crystals to precious rock crystals
- usable for different applications: crystals for decorative lighting, crystals for LED and fibre-optic, crystals for bath & furniture, crystals for decoration, crystals for the gift business

Marketing Advantages

- global reputation of "Austrian Crystal"
- world-wide Corporate Identity with our system of Distributors and Agents
- high relationship management and loyalty to our partners and customers
- high experience in doing international business resulting in fast and fluently procedures (customers in over 70 countries of the world, export-rate over 95 per cent)
- high service quality: pre- and post-sales-management
- information policy (newsletters, new products, sales campaigns etc.)

Company Advantages

- internationally registered brand-name "Schöler Crystal"
- old-established company (founded 1949) with a high sense of tradition
- company awards:
"Staatlich ausgezeichnetes Unternehmen" only given to the best companies in Austria
"Austria-Gütezeichen" from the ÖQA-Society (= Austrian work group for the support of quality); this is an award for high-end products and high production-standards and strong efforts for improvements in product and service quality
- unique combination of old traditional handcraft and newest technology
- big affinity in working with designers for handling lighting projects in palaces, castles, luxury-villas, hotels and government buildings



promotion material 1



sticker, mini
(20 mm)



sticker, small
(50 mm)



sticker, medium
(65 mm)



sticker, large
(120 mm)



window-sticker,
retail-shop,
small
(200 mm)



window-sticker,
retail-shop,
large
(390 mm)



promotion material 2



sample label,
carton



shop chandelier label,
crystal



chandelier label,
carton

promotion material 3



poster »crystal«,
textile
(2000 x 1000 mm)

promotion material 4



brochure »unlimited«



display »shop & fair«
(300 x 210 mm)



brochure »crystal«

promotion material 5



certificate »PARTNER«



pin



keyring



certificate »AGENT«

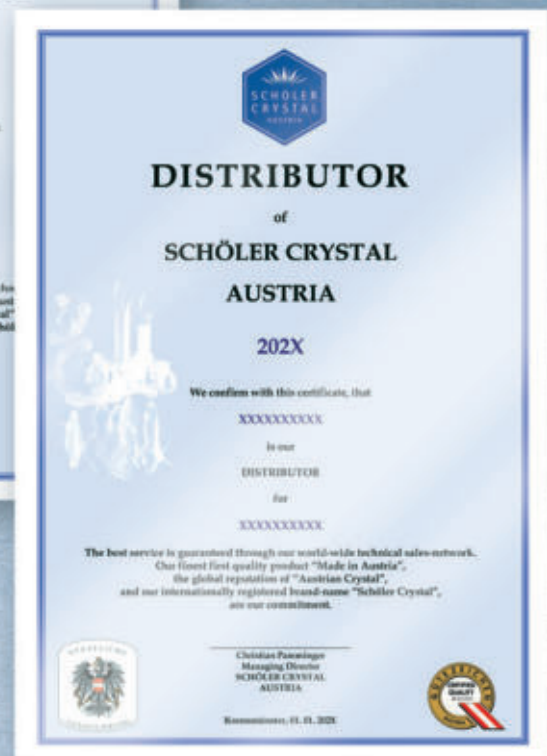

certificate »DISTRIBUTOR«



promotion material 6



ballpen



ruler



paperweight



writing case



carrybag

promotion material 7



display
»product lines«

promotion material 8



display
»colors & coatings«

| | size | EURO piece | minimum quantity pieces |
|-----------------|------------------------------------|------------|-------------------------|
| SCHOLER CRYSTAL | sticker, mini | 20 mm | 0,1611 10 |
| SCHOLER CRYSTAL | sticker, small | 50 mm | 0,6573 3 |
| SCHOLER CRYSTAL | sticker, medium | 65 mm | 0,6573 2 |
| SCHOLER CRYSTAL | sticker, large | 120 mm | 0,6573 1 |
| SCHOLER CRYSTAL | window-sticker, retail-shop, small | 200 mm | 2,4095 1 |
| SCHOLER CRYSTAL | window-sticker, retail-shop, large | 390 mm | 5,0572 1 |

promotion material 1

| | | | |
|-----------------|--------------------------------|-------|--------------|
| SCHOLER CRYSTAL | sample label, carton | 35 mm | 0,3010 100 |
| SCHOLER CRYSTAL | chandelier label, carton | 60 mm | 0,5803 100 |
| SCHOLER CRYSTAL | shop chandelier label, crystal | 60 mm | 5,5306 30 |

promotion material 2

| | | | |
|-----------------|------------------------------|----------------|-------------|
| SCHOLER CRYSTAL | poster, >>crystal<<, textile | 2000 x 1000 mm | 55,5490 1 |
|-----------------|------------------------------|----------------|-------------|

promotion material 3

| | | | |
|-----------------|--------------------------|--------------|-------------|
| SCHOLER CRYSTAL | brochure, >>crystal<< | 210 x 106 mm | 0,4210 50 |
| SCHOLER CRYSTAL | brochure, >>unlimited<< | 298 x 210 mm | 0,6866 50 |
| SCHOLER CRYSTAL | display, >>shop & fair<< | 300 x 210 mm | 15,5357 1 |

promotion material 4

| | | | |
|-----------------|---------------------------|--------------|----------------|
| SCHOLER CRYSTAL | pin | 17 mm | 5,7579 1 |
| SCHOLER CRYSTAL | keyring | 40 mm | 2,7285 1 |
| SCHOLER CRYSTAL | certificate "PARTNER" | 310 x 210 mm | on request 1 |
| SCHOLER CRYSTAL | certificate "AGENT" | 310 x 210 mm | on request 1 |
| SCHOLER CRYSTAL | certificate "DISTRIBUTOR" | 310 x 210 mm | on request 1 |

promotion material 5

| | | | |
|-----------------|--------------|--------------------|-------------|
| SCHOLER CRYSTAL | ballpen | 135 mm | 1,0156 1 |
| SCHOLER CRYSTAL | ruler | 213 x 60 mm | 1,7494 1 |
| SCHOLER CRYSTAL | paperweight | 80 x 70 x 20 mm | 29,4739 1 |
| SCHOLER CRYSTAL | writing case | 330 x 245 mm | 43,5953 1 |
| SCHOLER CRYSTAL | carrybag | 367 x 280 x 120 mm | 3,2270 1 |

promotion material 6

| | | | |
|-----------------|----------------------------------|--------------|-------------|
| SCHOLER CRYSTAL | sample display >>product lines<< | 317 x 210 mm | 76,2690 1 |
|-----------------|----------------------------------|--------------|-------------|

promotion material 7

| | | | |
|-----------------|--------------------------------------|--------------|--------------|
| SCHOLER CRYSTAL | sample display >>colors & coatings<< | 317 x 210 mm | 120,1441 1 |
|-----------------|--------------------------------------|--------------|--------------|

promotion material 8

GENERAL INFORMATION

Advanced technology and skilled craftsmanship form the product SCHÖLER CRYSTAL, crystals of finest quality and highest value.

Minor deviations in dimensions, crystal thickness, nuances in color, and occasional bubbles are a typical sign of handcrafting.

This catalog/pricelist shows a selection of our crystals. If you prefer your own designs, do not hesitate to ask for an offer. We will be glad to produce exclusively for you !

COLORS & COATINGS

CRYSTAL CLEAR ... transparent

CRYSTAL FROSTED ... surcharge: +50%(normal) +150%(small) ... all-side matt (frosted) finishing

CRYSTAL AB ... Aurora Borealis ... transparent with rosalin coating-color on one surface

CRYSTAL AFLAME ... transparent with fire-flame red coating-color on one surface

CRYSTAL AMBER ... transparent with light-gold coating-color on one surface

CRYSTAL ANTIQUE ... transparent with smoke coating-color on one surface

CRYSTAL GOLD ... transparent with gold coating-color on one surface

CRYSTAL SILVER ... transparent with silver coating-color on one surface

CRYSTAL BB ... Bermuda Blue ... non-transparent with violet coating-color on one surface and finally the same color is added on the back

CRYSTAL BW ... Bermuda Water ... non-transparent with blue coating-color on one surface and finally the same color is added on the back

CRYSTAL OG ... Orbit Gold ... non-transparent with gold coating-color on one surface and finally the same color is added on the back

CRYSTAL OS ... Orbit Silver ... non-transparent with silver coating-color on one surface and finally the same color is added on the back

CRYSTAL VL ... Vitrail Light ... non-transparent with blue-violet coating-color on one surface and finally the same color is added on the back

CRYSTAL VM ... Vitrail Medium ... non-transparent with green&violet coating-color on one surface and finally the same color is added on the back

ALEXANDRITE light purple

AMETHYST purple

AQUAMARINE light blue-green

EMERALD green

JET black

ROSALIN pink

RUBY red

SAPPHIRE blue

SMOKE grey

TOPAZ light brown

PACKING

BOX ... a box is a small carton
CARTON ... a carton includes several boxes, usually a dozen
Standard-Export-Packing ... is included in all our catalog-prices !
All shipments are carefully packed and checked by experienced professional packers !

SPECIAL PACKING

SINGLE PACKING ... surcharge ... +5% (on merchandise-value)
SET PACKING ... surcharge ... +3% (on merchandise-value)

PRICES

EURO / piece ... our prices are quoted in European Currency (EURO) per piece
EURO / kg ... only a few articles are quoted in European Currency (EURO) per kg

MINIMUM - ORDER - VALUE

EURO 250,-- ... per shipment
with regard to:
existing minimum-quantities or packing-units ... per article/size
For coated articles and special articles, we require 50% deposit-payment.

REDUCED - QUANTITY - ORDER

surcharge ... +25%
It is not possible to supply most articles in smaller quantities
than the mentioned minimum-quantity or packing-unit.
Where possible to do so a 25% surcharge will be applied.

BACKORDERS

Backorders with a value of less than EURO 25,-- are automatically cancelled.
All items not shipped are automatically placed on backorder.
If you do not wish to receive backorders, please notify us and your request will become part of your file.

SAMPLES

surcharge ... +25%
We are pleased to send you samples of all requested articles,
but we have to charge them to you (with a surcharge of +25%).
Exceptions from sample-invoicing are possible on inquiry.

General Terms & Conditions of Sale of Schöler & Co. GmbH

1. Validity

- 1.1 Our deliveries and services are exclusively effected on the basis of our General Terms and Conditions. General Terms and Conditions used by a customer do not become part of the agreement, and also this applies if we do not expressly object to the differing General Terms and Conditions of the customer and also if we carry out deliveries and services knowing about differing contractual provisions, or terms and conditions.
- 1.2 Our Terms and Conditions also apply to future deliveries and services even if our General Terms and Conditions are not expressly referred to.
- 1.3 A difference from our General Terms and Conditions may only be validly effected by making a corresponding agreement in writing that is signed by both parties.

2. Orders

- 2.1 Our offers are subject to change without notice. Orders are only accepted by us if confirmed by us in writing.
- 2.2 Subsequent changes in confirmed orders (such as changes in the ordered quantity or changes in the ordered articles, colors or qualities) are only possible with our confirmation.
- 2.3 If we have already rendered services on the basis of orders that are to be subsequently changed, the costs that have accrued by rendering the service are fully invoiced to the customer.
- 2.4 Orders that are already in the process of production may no longer be changed or cancelled unilaterally by the customer. Costs arising from the cancellation or changes are fully invoiced to the customer.
- 2.5 Minimum order quantities may apply as communicated by us.
- 2.6 Goods from call-off orders are to be accepted within the agreed period, however, in six months at the latest.

3. Product Specifications

- 3.1 We may change its product specifications at any time.
- 3.2 Information appearing in catalogs, brochures, etc. or qualities of a product such as color, quality or dimensions will be binding only when referenced in the order acknowledgment.
- 3.3 Deviations due to manufacturing process, e.g. in quantities, colors, dimensions, weights and product qualities are permissible.

4. Prices

- 4.1 Unless agreed otherwise in writing, our prices are net prices, to which value-added tax is to be added in the applicable statutory amount. This also applies to flat fees.
- 4.2 We reserve the right to adjust the agreed prices for deliveries and services to the wage and material costs corresponding to the time of the performance of services unless these are rendered within three months from making the agreement. This does not apply if a fixed price has been expressly agreed with the customer for the entire duration of the agreement.
- 4.3 Our prices apply to the agreed purchase quantities. In the event of reduced quantities, we reserve the right to adjust the prices correspondingly.
- 4.4 Services in addition and supplemental to the agreed scope of services are separately invoiced to the customer.

5. Terms of Payment

- 5.1 Payments are to be made by the customer to the accounts given on the invoice and within the period stated there.
- 5.2 Payment is effected when we may freely dispose of the funds. In case of payment in a freely convertible currency other than the invoice currency, the exchange risk and all related charges shall be borne by the client. All bank charges shall also be borne by the client.
- 5.3 Delay in payment by the customer occurs after the due date also without a reminder.
- 5.4 In the event of delay in payment by the customer, we charge interest on arrears in the amount of 12% p.a.
- 5.5 In addition, the customer is obligated to make good any costs of reminders and pursuing the claim including the costs of pursuing the claim out of the court. We reserve the right to assert higher damage claims caused by a delay.
- 5.6 Set-off by the customer with claims against us is excluded unless the counter-claim has been expressly acknowledged by us as existing and being due or has been declared by a final judicial title.
- 5.7 Complaints do not entitle the retention of payments.

6. Terms of Delivery

- 6.1 The delivery time arises under the agreement between the parties. A transaction for delivery on a fixed date is only provided if this has been expressly agreed on a fixed date is only provided if this has been expressly agreed by the parties in writing. Delivery periods relevant for us only start to run when all commercial and technical questions have been clarified and the customer has fulfilled any of its obligations (such as making a deposit-payment). A delivery time relevant for us is considered met if the service to be fulfilled by us is substantially rendered according to the agreement.
- 6.2 Should the dispatch of goods ready for shipment be delayed by circumstances beyond our control or for reasons attributable to the customer, we may have the goods stored at the risk and the expense of the customer. Upon such action, delivery and acceptance shall be deemed to have taken place, and payment becomes due accordingly.
- 6.3 If performance of the delivery is delayed for reasons that the customer is responsible for, we have the right to make other dispositions of the goods after expiration of a reasonable extension of time without rectification or, at our discretion, to render the goods within a reasonable extended period regardless of any other claims.
- 6.4 If performance of the service is delayed for reasons that are to be attributed to force majeure or other events outside our influence, a reasonable extension of the delivery period is agreed. As far as possible, the customer is immediately notified of the beginning and end of such circumstances.
- 6.5 If we delayed deliveries or services to be rendered by us for reasons that we are responsible for, we are liable for damage caused to the customer in the event of gross or wilful negligence. This is to be proven by the customer. Liability is limited to a maximum of 0.5% for each week of delay, however, in total to a maximum of 5% of the net value of the order. Otherwise the customer is entitled to repudiate the agreement in the scope of statutory provisions subject to the additional precondition of the expiration of a reasonable extension of time without rectification. In any event, our claim to payment of partial deliveries remains unaffected by any repudiation of the customer. Further claims of the client and claims exceeding this are excluded.
- 6.6 Claims of damages on the basis of non-performance are excluded excepting the event of gross or wilful negligence. In this event, our liability is limited to 5% of the net value of the order.
- 6.7 If it arises during the performance of our deliveries or services that the order cannot be carried out, we are entitled to cancel the agreement unless the customer agrees to a change of the agreement. In the event of repudiation, we are entitled to the pro-rata fee; the customer does not have any claims.
- 6.8 Our deliveries are effected on the basis of the international Incoterms 2000 that are specified in the offer or in the order confirmation. If not stated otherwise, we deliver ex works.
- 6.9 Effecting partial deliveries or rendering partial services is permitted as far as this is reasonable for the customer.
- 6.10 In absence of specific agreements the packaging is chosen by us.

7. Limited Warranty and Liability

- 7.1 Samples only represent and approximate condition of the goods to be delivered. Deviations in quantity and quality of the delivered goods that are customary in the trade do not represent defects that constitute warranty claims.
- 7.2 Deliveries from different production batches may also be subject to deviations customary in the trade that do not constitute any claims of the customer.
- 7.3 Details about characteristics of our products only represent a mere description of properties and are not to be regarded as a representation or warranty of characteristics.
- 7.4 We may prove the quality of our goods by means of certificates. Further examinations and certificates may be initiated on request. They are separately invoiced by us.
- 7.5 The customer is obligated to confirm acceptance in writing without delay. In any event, every delivery and service (also partial deliveries or partial services) is deemed as performed without defects if the customer does not report defects in writing without delay and within fourteen days after receipt of goods at destination at the latest.
- 7.6 The notification of defects in writing is to contain the following details: a) type of defect, b) complete article number, c) number of pieces, d) invoice number, e) date of receipt of the goods.
- 7.7 The warranty period is six months. Within this period, we warrant proper delivery or service and, at our discretion, warranty is restricted to improvement or exchange provided that the circumstance constituting the defect has already been given on the passing of risk and the customer has reported the defect in writing without delay. Unless expressly agreed otherwise, warranty is effected at the place of performance.
- 7.8 After notification by the customer, sufficient time and opportunity is to be granted to us to make the required improvements or additional deliveries; if this does not occur, we are not liable for any disadvantageous consequences arising from this. Only if it is absolutely necessary to prevent a threat to operational security or to avoid disproportionate damage, the customer is allowed to remove the defect itself or through third parties. In this event, the customer is to notify us without delay. The costs of a substituted removal are reimbursed by us up to the amount that we saved due to the substituted removal.
- 7.9 If the defect is not rectified in spite of improvement or exchange, the customer is entitled to reduce the fee; a right of repudiation is excluded.
- 7.10 No warranty exists for defects that are to be attributed to instructions of the customer or occur in materials or products made available by the customer. We are not obligated to comment on the suitability of instructions of the customer or on materials or products made available by the customer if we were not expressly charged with the examination. Likewise, claims of the customer are excluded if the customer or a third party makes improper improvements.
- 7.11 In the scope of deliveries and services that are essentially based on products of third parties, we only have a warranty obligation or liability for damages to the extent we are also entitled to warranty claims or claims for damages against third parties. We have the choice to be released from our obligation or liability by offering to the customer the assignment of our claims against third parties.
- 7.12 The customer is entitled to claims for damages on the basis of deficient performance only if it proves wilful or gross negligence to us. With regard to damage that does not arise in the deficient corporeal property itself, liability exists only provided that this is a damage that is to be attributed to culpable injury to life, body or health, fraudulently concealed defects or the absence of expressly represented characteristics. Per damage event, liability is limited to damages that are typical of agreements and can be reasonably foreseen by us as well as to compensation paid by our insurance. Further claims are excluded.
- 7.13 Our liability is limited to direct damage with respect to the goods themselves, and shall in no event exceed the amount paid to us for the relevant goods. In no event, we are liable for any indirect, incidental, special, punitive, consequential or other damages, however based and irrespective of whether we had knowledge of the possibility thereof, unless where liability is enforced by law in cases of wanton or gross negligence. The burden of proof is with the client.
- 7.14 Any recourse claims that parties or third parties address to us under the title of product liability in the meaning of the Product Liability Act are excluded unless the party entitled to recourse proves that the defect has been caused in our sphere and, at least, by gross negligence.
- 7.15 Returned goods require the confirmation of the seller. Costs that accrue from damages due to improper packaging during return transport are charged to the customer.
- 7.16 Avoidance of the agreement on the basis of error is excluded.

8. Industrial Protection Rights

- 8.1 The customer is entitled to utilize the trademark which is affixed to the goods or its packaging by us for the purpose of identification of the unchanged or originally packed goods. Any further utilization (e.g. the utilization of the trademark, the name, the logo or other industrial protection rights of us, together with trademarks, names or other industrial protection rights of the customer or third parties or for the purposes of identification of the customer's products or third parties' products) is prohibited. The utilization of our industrial protection rights in publications, irrespective of the medium, is only permitted after the prior written consent by us. Upon utilization of our trademark, the registration thereof should be identified, by way of the ® symbol.
- 8.2 Drawings and other technical documentation remain our property just the same as the models, catalogs, brochures, illustrations and such like and protected by the appropriate statutory provisions with regard to copying, imitation, competition etc. At the least upon takeover of such documentation, the customer accepts our right thereto and customer's obligation to keep this documentation confidential. The customer undertakes not to allow third parties partial or entire access thereto without the prior written consent of us or to utilize same for any other purpose than for the purpose for which such was submitted. In the event of orders not placed, all documentation has to be returned to us, in the event of orders being placed, only upon request.
- 8.3 The customer is obligated to point out our industrial protection rights and other before mentioned rights to its customers (this excludes consumers) and to obligate its customers to comply with and pass on the before mentioned provisions. This especially applies to the obligation to commit each further customer (with the exception of consumers) to comply with the before mentioned provisions.
- 8.4 We are not liable for the violation of industrial protection rights of third parties if goods are manufactured or brought into circulation due to drawings, designs, models, specifications or other manufacturer statements of the customer. The customer shall defend, indemnify and hold us harmless from any and all third party claims based on industrial protection rights or otherwise relating to uses of our products purchased by customer, and waives all its own claims.
- 8.5 The customer shall ensure that this article is made binding on all subsequent purchasers.

9. Retention of title

- 9.1 The goods delivered by us remain our exclusive property until they are completely paid. This retention of title also extends to the proceeds from the resale of goods delivered by us. These proceeds are to be separately kept without being mixed with other means of payment.
- 9.2 Processing or reprocessing of goods delivered and still owned by us is effected without any liabilities accruing to us from this. The exclusive title to the goods created by processing or reprocessing is also held by us until payment of our open accounts receivable.
- 9.3 The customer shall promptly oppose any third-party attachments (e.g. seizure or attachment) in respect of goods on which we have retained title or in respect of claims assigned to us, indicating our rights. Moreover, the customer shall inform us forthwith in writing of any such attachment, providing the necessary documentation (e.g. copy of the attachment order) for intervention.
- 9.4 Should the customer default on payment or should it otherwise breach its contractual obligations, we shall be entitled to enter customer's premises and to repossess goods that are its reserved property at the customer's expense or to demand assignment of the customer's claims for surrender against third parties.
- 9.5 The assertion of title retention rights, the repossession of goods or the seizure by us of its own goods shall not be deemed as withdrawal from the sales agreement.

10. Limitation

- 10.1 Any claims against us lapse after six months from the agreed acceptance of the delivery or service at the latest.

11. Final Clauses

- 11.1 If any provision of these General Terms and Conditions is invalid or becomes invalid on the basis of new statutory provisions, the other provisions not affected by this remain valid. The parties agree to replace the invalid provision by a valid provision whose content fulfils the commercial purpose of the invalid provision as closely as possible.
- 11.2 Modifications, amendments and supplemental agreements to contractual agreements are to be made in writing to take effect. This also applies to declarations that serve the establishment, exercise or preservation of rights.
- 11.3 The customer is forbidden from assigning contractual rights to third parties without our written consent.
- 11.4 Place of performance for any contractual obligations is 4550 Kremsmünster, Austria.
- 11.5 The exclusive venue for asserting claims against us is the court competent in 4550 Kremsmünster, Austria, with regard to the subject matter. We are entitled to make claims against the customer at our discretion either at the court competent in 4550 Kremsmünster, Austria, with regard to the subject matter or at the court competent with regard to the subject matter where the customer has its general jurisdiction or at a court of arbitration. Disputes that we bring before a court of arbitration are finally settled under the Rules of Arbitration and Conciliation of the International Arbitral Centre of the Austrian Federal Economic Chamber in Vienna (Vienna Rules) by three arbitrators appointed in accordance with these rules. The language to be used in the arbitral proceedings is German.
- 11.6 Austrian law applies with the exclusion of the conflict-of-law rules and with the exclusion of the UN Sales Convention.
- 11.7 In placing an order on the basis of this price-list, the customer expressly accepts the application of these General Terms and Conditions as most recently revised, and acknowledges their receipt.

Allgemeine Geschäftsbedingungen von Schöler & Co. GmbH

1. Geltung

- 1.1 Unsere Lieferungen und Leistungen erfolgen ausschließlich zu unseren Allgemeinen Geschäftsbedingungen. Allgemeine Geschäftsbedingungen, die ein Kunde verwendet, werden nicht Vertragsbestandteil, dies gilt auch dann, wenn wir den abweichenden Allgemeinen Geschäftsbedingungen des Kunden nicht ausdrücklich widersprechen, sowie ferner dann, wenn in Kenntnis abweichender Vertrags- oder Geschäftsbedingungen von uns Lieferungen oder Leistungen ausgeführt werden.
- 1.2 Unsere Allgemeinen Geschäftsbedingungen gelten auch für künftige Lieferungen und Leistungen, auch wenn nicht ausdrücklich auf unsere Allgemeinen Geschäftsbedingungen verwiesen wird.
- 1.3 Eine Abweichung von unseren Allgemeinen Geschäftsbedingungen kann nur dadurch wirksam erfolgen, dass eine entsprechende Vereinbarung schriftlich und von beiden Teilen unterfertigt abgeschlossen wird.

2. Aufträge

- 2.1 Unsere Angebote sind freibleibend. Aufträge sind von uns erst dann angenommen, wenn wir sie schriftlich bestätigt haben.
- 2.2 Nachträgliche Änderungen von bestätigten Aufträgen (wie etwa Änderungen der Bestellmenge, Änderung von bestellten Artikeln, Farben oder Qualitäten) sind nur mit unserer Zustimmung möglich.
- 2.3 Sollten von uns bereits Leistungen aufgrund von Aufträgen, die nachträglich abgeändert werden sollen, erbracht worden sein, werden die Kosten, die durch die Erbringung der Leistung verursacht wurden, dem Kunden voll in Rechnung gestellt.
- 2.4 Aufträge, die sich bereits in Produktion befinden, können vom Kunden nicht mehr einseitig geändert oder storniert werden. Kosten aus Storno oder Änderungen werden dem Kunden voll verrechnet.
- 2.5 Es gelten die von uns bekannt gegebenen Mindestbestellmengen.
- 2.6 Ware aus Abrufaufträgen ist innerhalb der vereinbarten Frist, spätestens jedoch nach sechs Monaten, abzunehmen.

3. Produktspezifikationen

- 3.1 Wir können unsere Produktspezifikationen jederzeit ändern.
- 3.2 Angaben in Katalogen, Broschüren, usw. oder Eigenschaften von Produkten wie Farbe, Beschaffenheit oder Abmessungen sind nur verbindlich, soweit in der Auftragsbestätigung ausdrücklich darauf Bezug genommen wird.
- 3.3 Durch den Herstellungsprozess bedingte Abweichungen, z.B. in Bezug auf Mengen, Farben, Abmessungen, Gewicht und Produkteigenschaften, sind erlaubt.

4. Preise

- 4.1 Soweit schriftlich nicht anders vereinbart, sind unsere Preise Nettopreise, zu denen Umsatzsteuer in der jeweils geltenden gesetzlichen Höhe hinzuzurechnen ist. Dies gilt auch für Pauschalpreise.
- 4.2 Wir behalten uns vor, die vereinbarten Preise für Lieferungen und Leistungen – soweit diese nicht innerhalb von drei Monaten nach Vertragsabschluss erbracht werden – den im Zeitpunkt der Leistungserbringung entstehenden Lohn und Materialkosten anzupassen. Dies gilt nicht, wenn mit dem Kunden ausdrücklich ein Festpreis für die gesamte Dauer des Vertrages vereinbart ist.
- 4.3 Unsere Preise gelten für die vereinbarten Abnahmemengen. Bei Minderabnahmen behalten wir uns das Recht vor, die Preise entsprechend anzupassen.
- 4.4 Neben- und Zusatzleistungen zum vereinbarten Leistungsumfang werden dem Kunden gesondert in Rechnung gestellt.

5. Zahlungsbedingungen

- 5.1 Zahlungen durch den Kunden sind auf eines in der Rechnung angegebenen Konten und binnen der dort angegebenen Frist zu erbringen.
- 5.2 Die Zahlung gilt als geleistet, wenn wir frei über diese verfügen können. Bei Zahlungen in anderen frei konvertierbaren Währungen als der Rechnungswährung trägt der Kunde das Wechselkursrisiko und alle aus der Zahlungsverpflichtung entstehenden Währungsdifferenzen. Sämtliche Bankspesen gehen zu Lasten des Kunden.
- 5.3 Zahlungsverzug des Kunden tritt bei Fälligkeit auch ohne Mahnung ein.
- 5.4 Im Falle eines Zahlungsverzuges des Kunden berechnen wir Verzugszinsen in der Höhe von 12% p.a.
- 5.5 Darüber hinaus ist der Kunde verpflichtet, sämtliche durch seinen Zahlungsverzug verursachten Mahn- und Anspruchsverfolgungskosten, einschließlich der Kosten außergerichtlicher Anspruchsverfolgung, zu ersetzen. Die Geltendmachung eines höheren Verzugschadens behalten wir uns vor.
- 5.6 Eine Aufrechnung durch den Kunden mit Forderungen gegen uns ist ausgeschlossen, sofern die Gegenforderung nicht von uns ausdrücklich als bestehend und fällig anerkannt wird oder durch rechtskräftigen gerichtlichen Titel festgestellt wurde.
- 5.7 Reklamationen berechtigten nicht zur Zurückhaltung von Zahlungen.

6. Lieferbedingungen

- 6.1 Die Lieferzeit ergibt sich aus den Vereinbarungen der Parteien. Ein Fixgeschäft liegt nur dann vor, wenn dies von den Parteien ausdrücklich schriftlich vereinbart wurde. Für uns maßgebliche Lieferfristen beginnen erst dann zu laufen, wenn alle kaufmännischen und technischen Fragen geklärt sind und der Kunde allen ihm treffenden Obliegenheiten (wie etwa der Leistung einer Anzahlung) nachgekommen ist. Eine für uns maßgebliche Lieferzeit gilt dann als eingehalten, wenn die von uns geschuldete Lieferung im wesentlichen vertragsgemäß bewirkt ist.
- 6.2 Falls die Absendung versandbereiter Ware ohne Verschulden von uns oder aus Gründen, die dem Kunden zurechenbar sind, nicht möglich ist, können wir die Lagerung der Ware auf Kosten und Gefahr des Kunden vornehmen. Dadurch gilt die Lieferung als erbracht und akzeptiert. Die vereinbarten Zahlungsbedingungen erfahren dadurch keine Änderung.
- 6.3 Verzögert sich die Erbringung der Lieferung aus Gründen, die der Kunde zu vertreten hat, so steht uns ungeachtet allfälliger sonstiger Ansprüche das Recht zu, nach fruchtlosem Ablauf einer angemessenen Nachfrist anderweitig über die Ware zu disponieren oder nach unserer Wahl innerhalb einer angemessenen verlängerten Frist zu liefern.
- 6.4 Verzögert sich die Erbringung der Lieferung aus Gründen, die auf höhere Gewalt oder sonstige außerhalb unseres Einflussbereiches liegende Ereignisse zurückzuführen sind, so gilt eine angemessene Verlängerung der Lieferfrist als vereinbart. Der Beginn und das Ende derartiger Umstände werden dem Kunden, soweit möglich, unverzüglich mitgeteilt. Die vorgenannten Umstände berechtigen auch dann zur Verlängerung der Lieferfrist, wenn sie bei Zulieferanten eintreten.
- 6.5 Sind wir mit den von uns zu erbringenden Lieferungen oder Leistungen aus Gründen, die wir zu vertreten haben, in Verzug geraten, haften wir im Fall der groben Fahrlässigkeit oder des Vorsatzes für beim Kunden verursachte Schäden. Dies ist vom Kunden nachzuweisen. Die Haftung ist beschränkt auf höchstens 0,5% für jede volle Woche der Verspätung, insgesamt aber höchstens 5% des Netto-Auftragswertes. Ansonsten ist der Kunde – unter der zusätzlichen Voraussetzung des fruchtlosen Ablaufs einer angemessenen Nachfrist – im Rahmen der gesetzlichen Vorschriften zum Rücktritt berechtigt. In jedem Fall bleibt unser Anspruch auf Zahlung von Teillieferungen von einem allfälligen Rücktritt des Kunden unberührt. Weitere und darüber hinausgehende Ansprüche des Kunden sind ausgeschlossen.
- 6.6 Schadenersatzansprüche wegen Nichterfüllung oder verspäteter Lieferung sind ausgeschlossen – ausgenommen den Fall der groben Fahrlässigkeit oder des Vorsatzes, die vom Kunden nachzuweisen sind. Unsere Haftung ist in diesem Fall mit 5% des Netto-Auftragswertes begrenzt.
- 6.7 Ergibt sich während der Durchführung unserer Lieferungen oder Leistungen, dass der Auftrag nicht ausgeführt werden kann, sind wir berechtigt, vom Vertrag zurückzutreten, es sei denn, der Kunde stimmt einer Änderung des Vertrages zu. Im Fall des Rücktritts gebührt uns das anteilige Entgelt; der Kunde hat keinerlei Ansprüche.
- 6.8 Unsere Lieferungen erfolgen auf Grund der internationalen Incoterms 2000, die im Angebot oder der Auftragsbestätigung spezifiziert werden. Falls nicht anders angegeben, liefern wir ab Werk.
- 6.9 Die Vornahme von Teillieferungen und die Erbringung von Teilleistungen ist zulässig, sofern dies für den Kunden zumutbar ist.
- 6.10 Wenn nicht anders vereinbart, entscheidet Schöler über die Verpackung.

7. Gewährleistung und Haftung

- 7.1 Muster stellen nur einen ungefähren Zustand der zu liefernden Ware dar. Branchenübliche Abweichungen in Quantität und Qualität der gelieferten Ware stellen keine Mängel dar, die Gewährleistungsansprüche begründen.
- 7.2 Lieferungen aus verschiedenen Produktionspartien können ebenso branchenüblichen Abweichungen unterliegen, die keine Ansprüche des Kunden begründen.
- 7.3 Angaben über Eigenschaften unserer Erzeugnisse stellen eine bloße Beschreibung von Beschaffenheitsmerkmalen dar und sind keinesfalls als Zusicherung oder Garantie von Eigenschaften anzusehen.
- 7.4 Die Qualität unserer Waren können wir durch Zertifikate nachweisen. Weitere Prüfungen und Zertifikate können auf Wunsch veranlasst werden. Sie werden von uns getrennt berechnet.
- 7.5 Der Kunde ist verpflichtet, eine erfolgreiche Abnahme unverzüglich schriftlich zu bestätigen. Jede Lieferung und Leistung (auch Teillieferung oder Teilleistung) gilt jedenfalls als mangelfrei erbracht, wenn der Kunde nicht unverzüglich, längstens binnen vierzehn Tagen nach Wareneingang am Bestimmungsort, Mängel schriftlich anzeigt.
- 7.6 Die schriftliche Mängelanzeige muss folgende Angaben enthalten: a) Art des Mangels, b) komplette Artikelnummer, c) Stückanzahl, d) Rechnungsnummer, e) Datum des Wareneinganges.
- 7.7 Die Gewährleistungsfrist beträgt sechs Monate. Innerhalb dieser Frist leisten wir für ordnungsgemäße Lieferung oder Leistung Gewähr, wobei die Gewährleistung nach unserer Wahl auf Verbesserung oder Austausch beschränkt ist, vorausgesetzt der die Mangelhaftigkeit begründete Umstand ist bereits bei Gefahrübergang vorgelegen und der Kunde hat den Mangel unverzüglich schriftlich angezeigt. Wenn nicht ausdrücklich etwas anderes vereinbart ist, erfolgt die Gewährleistung am Erfüllungsort.
- 7.8 Zur Vornahme einer erforderlichen Verbesserung oder Nachlieferung ist uns nach Verständigung durch den Kunden ausreichend Zeit und Gelegenheit zu geben; geschieht dies nicht, so trifft uns keine Haftung für die daraus entstehenden nachteiligen Folgen. Lediglich dann, wenn dies unbedingt erforderlich ist, um eine Gefährdung der Betriebssicherheit zu vermeiden oder unverhältnismäßige Schäden abzuwehren, kommt dem Kunden die Befugnis zu, die Beseitigung eines Mangels selbst vorzunehmen oder durch Dritte vornehmen zu lassen. In solchen Fällen hat uns der Kunde unverzüglich zu verständigen. Der Aufwand einer Ersatzvornahme wird von uns bis zur Höhe des Betrages ersetzt, den wir uns durch die Ersatzvornahme erspart haben.
- 7.9 Wird der Mangel trotz Verbesserung oder Austausch nicht behoben, ist der Kunde berechtigt, das Entgelt zu mindern; ein Rücktrittsrecht ist ausgeschlossen.
- 7.10 Für Mängel, welche auf Anweisung des Kunden zurückzuführen sind oder welche an vom Kunden bereitgestellten Materialien und Erzeugnissen auftreten, besteht keine Gewährleistung. Uns trifft keine Verpflichtung, auf die Tauglichkeit von Anweisungen des Kunden oder der von ihm bereit gestellten Materialien oder Erzeugnisse hinzuweisen, wenn wir nicht ausdrücklich mit der Überprüfung beauftragt worden sind. Ebenso sind Ansprüche des Kunden ausgeschlossen, wenn er oder ein Dritter eine unsachgemäße Verbesserung vornimmt.
- 7.11 Im Rahmen von Lieferungen oder Leistungen, welche im Wesentlichen auf den Erzeugnissen Dritter beruhen, trifft uns eine Gewährleistungsverpflichtung oder eine Verpflichtung zum Schadenersatz nur insoweit, als uns selbst Gewährleistungs- oder Schadenersatzansprüche gegen den Dritten zustehen. Uns kommt wahlweise die Möglichkeit zu, uns von unseren Verpflichtungen zu befreien, indem wir unsere Ansprüche gegen den Dritten dem Kunden zur Abtretung anbieten.

- 7.12 Schadenersatzansprüche wegen mangelhafter Erfüllung stehen dem Kunden nur dann zu, wenn er uns Vorsatz oder grobe Fahrlässigkeit nachweist. Im Hinblick auf Schäden, welche nicht an der mangelhaften Sache selbst entstehen, besteht eine Haftung außerdem nur unter der weiteren Voraussetzung, dass es sich um Schäden, die auf eine schuldhaft Verletzung von Leben, Körper oder Gesundheit, auf arglistig verschwiegene Mängel sowie das Fehlen ausdrücklich zugesicherter Eigenschaften zurückzuführen sind. Die Haftung ist – pro Schadensfall – auf vertragstypische, von uns vernünftigerweise vorhersehbare Schäden sowie die von unserer Versicherung erbrachte Ersatzleistungen beschränkt. Weitere Ansprüche sind ausgeschlossen.
 - 7.13 Unsere Haftung bleibt auf Schäden beschränkt, die an der Ware selbst entstehen; die Haftungssumme ist in jedem Fall auf die Höhe des Betrages beschränkt, den wir für die betroffene Ware erhalten haben. Jegliche Ansprüche auf indirekte und Folgeschäden einschließlich des entgangenen Gewinns sowie sonstige wie auch immer begründete Schäden sind ausgeschlossen. Davon ausgenommen sind Fälle des Vorsatzes sowie grober Fahrlässigkeit. Wir haften nicht für Fahrlässigkeit, soweit gesetzlich nicht zwingend vorgeschrieben. Die Beweislast liegt beim Kunden.
 - 7.14 Allfällige Regressforderungen, die Vertragspartner oder Dritte aus dem Titel der Produkthaftung im Sinn des Produkthaftungsgesetzes gegen uns richten, sind ausgeschlossen, es sei denn, der Regressberechtigte weist nach, dass der Fehler in unserer Sphäre verursacht und zumindest grob fahrlässig verschuldet wurde.
 - 7.15 Retoursendungen bedürfen des Einverständnisses des Verkäufers. Für Kosten, die durch Schäden auf Grund unsachgemäßer Verpackung beim Rücktransport entstehen, wird der Käufer belastet.
 - 7.16 Eine Anfechtung des Vertrages wegen Irrtum ist ausgeschlossen.
8. Gewerbliche Schutzrechte
- 8.1 Der Kunde ist berechtigt, die von uns an der Ware oder ihrer Verpackung angebrachte Marke zur Identifizierung der unveränderten oder originalverpackten Ware zu benutzen. Jede darüber hinaus gehende Benutzung (z.B. die Verwendung der Marke, des Namens, des Logos oder sonstiger gewerblicher Schutzrechte von uns, zusammen mit Marken, Namen oder sonstigen gewerblichen Schutzrechten des Kunden oder Dritter oder zur Kennzeichnung von Produkten des Kunden oder Dritter) ist verboten. Die Verwendung unserer gewerblichen Schutzrechte in Veröffentlichungen, gleichgültig in welchem Medium, ist nur nach vorheriger schriftlicher Zustimmung von uns erlaubt. Bei der Verwendung unserer Marke ist auf deren Registrierung durch das Zeichen @ hinzuweisen.
 - 8.2 Skizzen und sonstige technische Unterlagen bleiben, ebenso wie Muster, Kataloge, Prospekte, Abbildungen und dergleichen, stets in unserem Eigentum und sind durch die einschlägigen gesetzlichen Bestimmungen hinsichtlich Vervielfältigung, Nachahmung, Wettbewerb usw. geschützt. Spätestens mit Entgegennahme dieser Unterlagen erkennt der Kunde unserer Rechte an den Unterlagen sowie seine Pflicht, diese vertraulich zu behandeln, an. Der Kunde verpflichtet sich, diese Unterlagen nicht ohne vorherige schriftliche Zustimmung von uns ganz oder teilweise Dritten zugänglich zu machen oder außerhalb des Zweckes zu verwenden, zu dem sie übergeben worden sind. Im Falle nicht erteilter Bestellungen sind sämtliche Unterlagen an uns zurückzugeben, im Falle erteilter Bestellungen nur auf Verlangen.
 - 8.3 Der Kunde ist verpflichtet, seine Abnehmer (mit Ausnahme von Konsumenten) auf die gewerblichen Schutzrechte und sonstigen vorbezeichneten Rechte von uns hinzuweisen und sie zur Einhaltung und Weitergabe der vorstehenden Bestimmungen zu verpflichten. Dies betrifft insbesondere die Verpflichtung, jeden weiteren Abnehmer (mit Ausnahme von Konsumenten) zur Einhaltung der vorstehenden Bestimmungen zu verpflichten.
 - 8.4 Wir haften nicht für die Verletzung von gewerblichen Schutzrechten Dritter, wenn Ware auf Grund von Zeichnungen, Entwürfen, Modellen, Spezifikationen oder von sonstigen Herstellerangaben des Kunden hergestellt oder in Verkehr gebracht wird. Der Kunde stellt uns in solchen Fällen von jeglicher Haftung oder Inanspruchnahme frei und verzichtet auf alle eigenen Ansprüche.
 - 8.5 Der Kunde verpflichtet sich, die Bestimmungen dieses Abschnittes auf alle späteren Erwerber zu übertragen.
9. Eigentumsvorbehalt
- 9.1 Die von uns gelieferten Waren stehen bis zu deren vollständiger Bezahlung in unserem ausschließlichen Eigentum. Dieser Eigentumsvorbehalt erstreckt sich auch auf den Erlös aus dem Weiterverkauf der von uns gelieferten Waren. Dieser Erlös ist ohne Vermengung mit anderen Zahlungsmitteln gesondert zu verwahren.
 - 9.2 Die Verarbeitung oder Bearbeitung von uns gelieferter, noch in unserem Eigentum stehender Ware erfolgt, ohne dass für uns Verbindlichkeiten hieraus erwachsen. An den nach Be- oder Verarbeitung entstandenen Waren steht das ausschließliche Eigentumsrecht bis zur Bezahlung unserer offenen Forderungen ebenfalls uns zu.
 - 9.3 Zugriffen Dritter (z.B. Pfändung oder Beschlagnahmen) auf die unter Eigentumsvorbehalt gelieferte Ware oder auf die an uns abgetretenen Forderungen hat der Kunde unverzüglich unter Hinweis auf unsere Rechte zu widersprechen. Ferner hat er uns sofort von diesen Zugriffen schriftlich, unter Überlassung der für eine Intervention erforderlichen Unterlagen (z.B. Abschrift des Pfändungsprotokolls) zu unterrichten.
 - 9.4 Bei Zahlungsverzug und sonstigem vertragswidrigem Verhalten des Kunden sind wir berechtigt, die Geschäftsräumlichkeiten des Kunden zu betreten und die Vorbehaltsware auf Kosten des Kunden in Besitz zu nehmen oder die Abtretung der Herausgabeansprüche des Kunden gegen Dritte zu verlangen.
 - 9.5 Die Geltendmachung von Eigentumsvorbehalten bzw. die Rücknahme der Ware sowie eine etwaige Pfändung der Ware durch uns selbst gelten nicht als Rücktritt vom Vertrag.
10. Verjährung
- 10.1 Sämtliche Ansprüche gegen uns verjähren spätestens sechs Monate ab der vereinbarten Abnahme der Lieferung oder Leistung.
11. Schlussbestimmungen
- 11.1 Sollte eine Bestimmung dieser Allgemeinen Geschäftsbedingungen unwirksam sein oder durch neue gesetzliche Bestimmung unwirksam werden, so bleiben die hiervon nicht betroffenen übrigen Bestimmungen unverändert wirksam. Die Parteien verpflichten sich, die unwirksame Bestimmung durch eine wirksame Bestimmung jenen Inhalts zu ersetzen, die wirtschaftlich der unwirksamen Bestimmung am nächsten kommt.
 - 11.2 Änderungen, Ergänzungen und Nebenabreden zu vertraglichen Vereinbarungen bedürfen zu ihrer Wirksamkeit der Schriftform. Dies gilt gleichermaßen für Erklärungen, welche der Begründung, Ausübung oder Wahrung von Rechten dienen.
 - 11.3 Dem Kunden ist es untersagt, vertragliche Rechte ohne unsere schriftliche Zustimmung auf Dritte zu übertragen.
 - 11.4 Erfüllungsort für sämtliche Vertragspflichten ist 4550 Kremsmünster, Österreich.
 - 11.5 Ausschließlicher Gerichtsstand zur Geltendmachung von Ansprüchen gegen uns ist das für 4550 Kremsmünster, Österreich, sachlich zuständige Gericht. Wir sind berechtigt, nach unserer Wahl den Kunden entweder bei dem sachlich für 4550 Kremsmünster, Österreich, zuständigen Gericht, oder bei dem sachlich zuständigen Gericht, vor dem der Kunde seinen allgemeinen Gerichtsstand hat oder bei einem Schiedsgericht in Anspruch zu nehmen. Streitigkeiten, die wir vor ein Schiedsgericht bringen, werden nach der Schieds- und Schlichtungsordnung des internationalen Schiedsgerichts der Wirtschaftskammer Österreich in Wien (Wiener Regeln) von drei gemäß diesen Regeln ernannten Schiedsrichtern endgültig entschieden. Im Schiedsverfahren ist die deutsche Sprache zu verwenden.
 - 11.6 Es gilt österreichisches Recht unter Ausschluss der Verweisungsnormen sowie unter Ausschluss des UN-Kaufrechts.
 - 11.7 Mit Bestellung auf Grundlage dieser Preisliste erkennt der Kunde die Geltung dieser Allgemeinen Geschäftsbedingungen in der jeweils geltenden Fassung ausdrücklich an und bestätigt deren Zugang.

Schöler & Co. GmbH

Gablonzer Strasse 54-61
A-4550 Kremsmünster
Austria

T: ++43-7583-7723

F: ++43-7583-7812

E: office@scholer-crystal.at

W: www.scholer-crystal.at



We kindly ask you to effect remittance favouring one of our accounts :

BANKS & ACCOUNTS

BANK: UniCredit Bank Austria
ADDRESS: Hauptplatz 27, 4021 Linz, Austria
BENEFICIARY: Schöler & Co. GmbH
IBAN: AT74 1100 0009 2307 9800
BIC (SWIFT): BKAUATWW
ACCOUNT: 00923079800
BANK CODE: 11000

or

BANK: Allgemeine Sparkasse Oberösterreich
ADDRESS: Rathausplatz 9, 4550 Kremsmünster, Austria
BENEFICIARY: Schöler & Co. GmbH
IBAN: AT12 2032 0226 0000 1064
BIC (SWIFT): ASPKAT2LXXX
ACCOUNT: 22600001064
BANK CODE: 20320

or

BANK: Raiffeisenbank Region Kirchdorf
ADDRESS: Marktplatz 8, 4550 Kremsmünster, Austria
BENEFICIARY: Schöler & Co. GmbH
IBAN: AT61 3438 0000 0622 5155
BIC (SWIFT): RZ00AT2L380
ACCOUNT: 00006225155
BANK CODE: 34380

MILLIMETER**INCHES**

The dimensions which are written in bold are the most popular sizes.

| | | |
|---------------|---|---------------|
| 20 mm | ↔ | 3/4" |
| 25 mm | ↔ | 1" |
| 32 mm | ↔ | 1 1/4" |
| 38 mm | ↔ | 1 1/2" |
| 45 mm | ↔ | 1 3/4" |
| 50 mm | ↔ | 2" |
| 58 mm | ↔ | 2 1/4" |
| 63 mm | ↔ | 2 1/2" |
| 70 mm | ↔ | 2 3/4" |
| 76 mm | ↔ | 3" |
| 85 mm | ↔ | 3 1/3" |
| 89 mm | ↔ | 3 1/2" |
| 95 mm | ↔ | 3 3/4" |
| 100 mm | ↔ | 4" |
| 110 mm | ↔ | 4 1/3" |
| 115 mm | ↔ | 4 1/2" |
| 120 mm | ↔ | 4 3/4" |
| 125 mm | ↔ | 5" |
| 140 mm | ↔ | 5 1/2" |
| 150 mm | ↔ | 6" |
| 165 mm | ↔ | 6 1/2" |
| 175 mm | ↔ | 7" |
| 190 mm | ↔ | 7 1/2" |
| 200 mm | ↔ | 8" |
| 225 mm | ↔ | 9" |
| 250 mm | ↔ | 10" |
| 275 mm | ↔ | 11" |
| 300 mm | ↔ | 12" |
| 360 mm | ↔ | 14" |
| 400 mm | ↔ | 16" |
| 450 mm | ↔ | 18" |
| 500 mm | ↔ | 20" |
| 550 mm | ↔ | 22" |
| 600 mm | ↔ | 24" |
| 650 mm | ↔ | 26" |
| 700 mm | ↔ | 28" |
| 800 mm | ↔ | 32" |
| 900 mm | ↔ | 36" |
| 1000 mm | ↔ | 40" |

FANTASTIC

optic crystal
fantastic brilliance
machine-cut
innovative shapes

CLASSIC

optic crystal
classic brilliance
hand-cut
historic shapes

ECONOMIC

chandelier crystal
slight brilliance
machine-pressed
standard shapes

BASIC

chandelier crystal
excellent brilliance
hand/machine-cut
popular shapes

ASFOUR

lead crystal
magnificent brilliance
machine-cut
made by Asfour

PRECIOSA

lead crystal
glamorous brilliance
machine-cut
made by Preciosa

ROCKCRYSTAL

quartz crystal
elemental brilliance
hand-cut
unique inclusions by nature

ZIP

fine crystal
premium quality
lamp-parts & accessories
fast pinning service

INTERIOR

fine crystal
premium quality
creative sparkling designs
customized interior solutions

DECORATION

fine crystal
premium quality
skillfully hand-made
sensational collectibles & gifts

TABLEWARE

fine crystal
premium quality
mouth-blown & hand-made
contemporary straight glasses

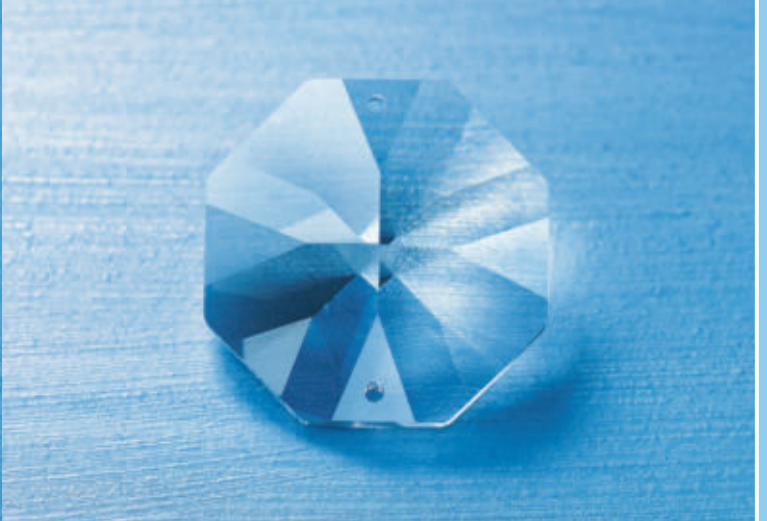

FANTASTIC



FANTASTIC

optic crystal

fantastic brilliance

machine-cut

innovative shapes

pinning service available

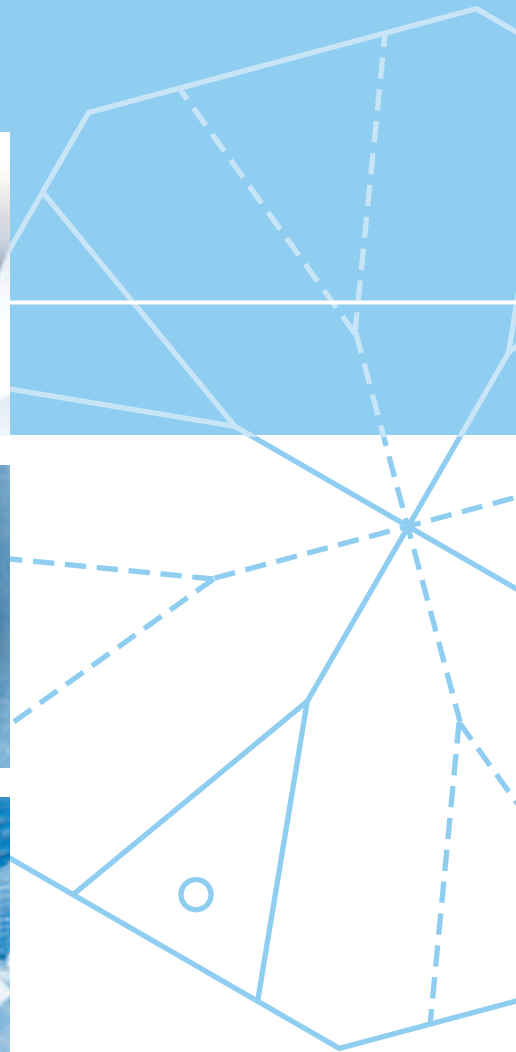

Schöler & Co. GmbH

Gablonzer Strasse 54-61

A-4550 Kremsmünster

Austria

T: ++43-75 83-77 23

F: ++43-75 83-78 12

E: office@scholer-crystal.at

W: www.scholer-crystal.at

















ARTICLE INDEX

| Article: | Page: | Article: | Page: |
|-----------------|--------------|-----------------|--------------|
| F.3200 | 7 | F.3365 | 16 |
| F.3201 | 7 | F.3371 | 16 |
| F.3203 | 7 | F.3377 | 18 |
| F.3204 | 7 | F.3380 | 18 |
| F.3205 | 11 | F.3384 | 20 |
| F.3206 | 12 | F.3385 | 20 |
| F.3208 | 12 | F.3386 | 18 |
| F.3210 | 14 | F.3387 | 20 |
| F.3212 | 12 | F.3388 | 20 |
| F.3213 | 18 | F.3389 | 20 |
| F.3214 | 12 | F.3390 | 21 |
| F.3215 | 11 | F.3392 | 21 |
| F.3216 | 15 | F.3393 | 21 |
| F.3217 | 15 | F.3394 | 21 |
| F.3218 | 18 | F.3396 | 21 |
| F.3220 | 13 | F.3400 | 8 |
| F.3221 | 17 | F.3401 | 8 |
| F.3223 | 17 | F.3403 | 8 |
| F.3225 | 13 | F.3404 | 8 |
| F.3226 | 13 | F.3420 | 19 |
| F.3227 | 17 | F.3430 | 19 |
| F.3228 | 14 | F.3440 | 19 |
| F.3229 | 19 | F.3676 | 14 |
| F.3230 | 19 | F.3710 | 22 |
| F.3238 | 18 | F.3720 | 22 |
| F.3240 | 10 | F.3730 | 22 |
| F.3241 | 10 | F.3740 | 22 |
| F.3245 | 11 | F.3850 | 23 |
| F.3250 | 11 | F.3851 | 23 |
| F.3260 | 10 | F.3855 | 23 |
| F.3261 | 10 | | |
| F.3270 | 10 | | |
| F.3271 | 10 | | |
| F.3280 | 11 | | |
| F.3281 | 11 | | |
| F.3282 | 12 | | |
| F.3284 | 12 | | |
| F.3291 | 17 | | |
| F.3293 | 17 | | |
| F.3295 | 17 | | |
| F.3300 | 9 | | |
| F.3301 | 9 | | |
| F.3303 | 9 | | |
| F.3304 | 9 | | |
| F.3310 | 14 | | |
| F.3320 | 13 | | |
| F.3322 | 13 | | |
| F.3324 | 13 | | |
| F.3327 | 16 | | |
| F.3328 | 15 | | |
| F.3337 | 16 | | |
| F.3340 | 14 | | |
| F.3342 | 14 | | |
| F.3344 | 14 | | |
| F.3347 | 16 | | |
| F.3350 | 15 | | |
| F.3351 | 15 | | |
| F.3352 | 15 | | |
| F.3353 | 15 | | |
| F.3361 | 16 | | |

PRODUCT GROUP

Page:

| | | |
|--|---|---------|
| OCTAGONS |  | 7 - 9 |
| SQUARE STONES & COFFIN STONES & RECTANGLE STONES |  | 10 - 11 |
| BALLS & PRISMS |  | 11 + 14 |
| DROPS |  | 12 |
| ICICLES |  | 13 |
| ROUNDS |  | 14 - 15 |
| OVALS |  | 16 |
| FLOWERS & STARS |  | 17 |
| ALMONDS (KITE-SHAPED) |  | 18 |
| ALMONDS (TRADITIONAL) |  | 19 |
| ALMONDS (MODERN) |  | 20 |
| PENDELOQUES |  | 21 |
| CENTERPIECES |  | 22 |
| BOBECHES |  | 23 |

| CRYSTAL | CRYSTAL coated | COLOR | COLOR coated | minimum quantity | |
|---------------|--|---|--|---------------------|------------------|
| CLEAR | AB AFLAME AMBER ANTIQUE GOLD SILVER | ALEXANDRITE AMETHYST AQUAMARINE EMERALD JET ROSA LIN RUBY SAPPHIRE SMOKE TOPAZ | AB AFLAME AMBER ANTIQUE GOLD SILVER | | |
| | BB BW OG OS VL VM | | BB BW OG OS VL VM | | |
| EURO piece | EURO piece | EURO piece | EURO piece | BOX pieces | CARTON pieces |

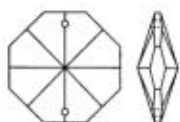

F.3200

| | | | | | | |
|--------|---------|---------|--------|--------|-------|--------|
| 10 mm | 0,0630 | 0,2157 | | | 3.300 | 39.600 |
| 12 mm | 0,0667 | 0,2194 | | | 2.200 | 26.400 |
| 14 mm | 0,0640 | 0,1902 | 0,1685 | 0,3027 | 1.800 | 21.600 |
| 16 mm | 0,1150 | 0,2712 | 0,3094 | 0,4656 | 900 | 10.800 |
| 18 mm | 0,1869 | 0,3860 | 0,5027 | 0,7017 | 640 | 7.680 |
| 20 mm | 0,2301 | 0,4801 | 0,6186 | 0,8685 | 420 | 5.040 |
| 22 mm | 0,2876 | 0,5665 | 0,7030 | 0,9819 | 300 | 3.600 |
| 24 mm | 0,3738 | 0,7022 | 0,9138 | 1,2422 | 240 | 2.880 |
| 26 mm | 0,4314 | 0,8248 | 1,0544 | 1,4478 | 200 | 2.400 |
| 28 mm | 0,5176 | 0,9753 | 1,2653 | 1,7230 | 150 | 1.800 |
| 30 mm | 0,5860 | 1,0993 | 1,4324 | 1,9459 | 125 | 1.500 |
| 32 mm | 0,6446 | 1,2010 | 1,5756 | 2,1321 | 100 | 1.200 |
| 34 mm | 0,8614 | 1,4745 | 1,8950 | 2,5081 | 80 | 960 |
| 36 mm | 0,9871 | 1,6551 | 2,1716 | 2,8396 | 80 | 960 |
| 38 mm | 1,1305 | 1,8929 | 2,4872 | 3,2495 | 80 | 960 |
| 40 mm | 1,2814 | 2,1485 | 2,8190 | 3,6862 | 80 | 960 |
| 50 mm | 1,8654 | 3,2448 | 4,1039 | 5,4833 | 30 | 360 |
| 60 mm | 2,8305 | 4,8161 | 6,2269 | 8,2126 | 20 | 240 |
| 70 mm | 4,5586 | 7,7791 | | | 8 | 96 |
| 80 mm | 7,2937 | 12,0089 | | | 6 | 72 |
| 90 mm | 11,6700 | 17,7106 | | | 6 | 72 |
| 100 mm | 18,6721 | 26,2592 | | | 6 | 72 |
| 110 mm | 29,8752 | 37,6329 | | | 4 | 48 |
| 120 mm | 47,8005 | 55,9499 | | | 4 | 48 |

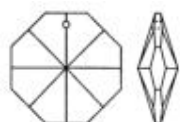

F.3201

| | | | | | | |
|--------|---------|---------|--------|--------|-------|--------|
| 10 mm | 0,0630 | 0,2157 | | | 3.300 | 39.600 |
| 12 mm | 0,0667 | 0,2194 | | | 2.200 | 26.400 |
| 14 mm | 0,0640 | 0,1902 | 0,1685 | 0,3027 | 1.800 | 21.600 |
| 16 mm | 0,1150 | 0,2712 | 0,3094 | 0,4656 | 900 | 10.800 |
| 18 mm | 0,1869 | 0,3860 | 0,5027 | 0,7017 | 640 | 7.680 |
| 20 mm | 0,2301 | 0,4801 | 0,6186 | 0,8685 | 420 | 5.040 |
| 22 mm | 0,2876 | 0,5665 | 0,7030 | 0,9819 | 300 | 3.600 |
| 24 mm | 0,3738 | 0,7022 | 0,9138 | 1,2422 | 240 | 2.880 |
| 26 mm | 0,4314 | 0,8248 | 1,0544 | 1,4478 | 200 | 2.400 |
| 28 mm | 0,5176 | 0,9753 | 1,2653 | 1,7230 | 150 | 1.800 |
| 30 mm | 0,5860 | 1,0993 | 1,4324 | 1,9459 | 125 | 1.500 |
| 32 mm | 0,6446 | 1,2010 | 1,5756 | 2,1321 | 100 | 1.200 |
| 34 mm | 0,8614 | 1,4745 | 1,8950 | 2,5081 | 80 | 960 |
| 36 mm | 0,9871 | 1,6551 | 2,1716 | 2,8396 | 80 | 960 |
| 38 mm | 1,1305 | 1,8929 | 2,4872 | 3,2495 | 80 | 960 |
| 40 mm | 1,2814 | 2,1485 | 2,8190 | 3,6862 | 80 | 960 |
| 50 mm | 1,8654 | 3,2448 | 4,1039 | 5,4833 | 30 | 360 |
| 60 mm | 2,8305 | 4,8161 | 6,2269 | 8,2126 | 20 | 240 |
| 70 mm | 4,5586 | 7,7791 | | | 8 | 96 |
| 80 mm | 7,2937 | 12,0089 | | | 6 | 72 |
| 90 mm | 11,6700 | 17,7106 | | | 6 | 72 |
| 100 mm | 18,6721 | 26,2592 | | | 6 | 72 |
| 110 mm | 29,8752 | 37,6329 | | | 4 | 48 |
| 120 mm | 47,8005 | 55,9499 | | | 4 | 48 |

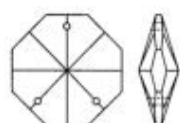

F.3203

| | | | | | | |
|-------|--------|--------|--------|--------|-------|--------|
| 14 mm | 0,0939 | 0,2466 | | | 1.800 | 21.600 |
| 18 mm | 0,2849 | 0,4838 | | | 640 | 7.680 |
| 22 mm | 0,4785 | 0,7574 | 1,0528 | 1,3317 | 300 | 3.600 |
| 40 mm | 1,6780 | 2,5451 | 3,6916 | 4,5587 | 80 | 960 |

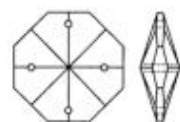

F.3204

| | | | | | | |
|-------|--------|--------|--------|--------|-------|--------|
| 14 mm | 0,0939 | 0,2466 | | | 1.800 | 21.600 |
| 16 mm | 0,1519 | 0,3304 | 0,3206 | 0,4769 | 900 | 10.800 |
| 18 mm | 0,2849 | 0,4838 | | | 640 | 7.680 |
| 22 mm | 0,4785 | 0,7574 | 1,0528 | 1,3317 | 300 | 3.600 |
| 40 mm | 1,6780 | 2,5451 | 3,6916 | 4,5587 | 80 | 960 |

| CRYSTAL | CRYSTAL <u>coated</u> | C O L O R | C O L O R <u>coated</u> | minimum quantity | |
|---------------|--|---|--|---------------------|------------------|
| CLEAR | AB AFLAME AMBER ANTIQUE GOLD SILVER | ALEXANDRITE AMETHYST AQUAMARINE EMERALD JET ROSA LIN RUBY SAPPHIRE SMOKE TOPAZ | AB AFLAME AMBER ANTIQUE GOLD SILVER | | |
| | BB BW OG OS VL VM | | BB BW OG OS VL VM | | |
| EURO piece | EURO piece | EURO piece | EURO piece | BOX pieces | CARTON pieces |

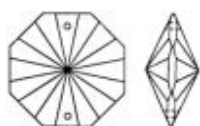

F.3400

| | | | | | | |
|-------|--------|--------|--------|--------|-------|--------|
| 10 mm | 0,0766 | 0,2293 | | | 3.300 | 39.600 |
| 12 mm | 0,0827 | 0,2354 | | | 2.200 | 26.400 |
| 14 mm | 0,0741 | 0,2083 | | | 1.800 | 21.600 |
| 16 mm | 0,1367 | 0,2757 | | | 900 | 10.800 |
| 18 mm | 0,2014 | 0,3557 | | | 640 | 7.680 |
| 20 mm | 0,3771 | 0,6272 | 0,8297 | 1,0798 | 420 | 5.040 |
| 22 mm | 0,4880 | 0,7669 | 1,0737 | 1,3526 | 300 | 3.600 |
| 24 mm | 0,5684 | 0,8968 | 1,2504 | 1,5788 | 240 | 2.880 |
| 26 mm | 0,6618 | 1,0552 | 1,4559 | 1,8494 | 200 | 2.400 |
| 28 mm | 0,7858 | 1,2436 | 1,7289 | 2,1866 | 150 | 1.800 |
| 30 mm | 0,8686 | 1,3819 | 1,9110 | 2,4243 | 125 | 1.500 |
| 32 mm | 0,9513 | 1,5078 | 2,0929 | 2,6493 | 100 | 1.200 |
| 34 mm | 1,1972 | 1,8103 | 2,6338 | 3,2470 | 80 | 960 |
| 36 mm | 1,3884 | 2,0565 | 3,0546 | 3,7227 | 80 | 960 |
| 38 mm | 1,5324 | 2,2947 | 3,3710 | 4,1333 | 80 | 960 |
| 40 mm | 1,7238 | 2,5909 | 3,7922 | 4,6594 | 80 | 960 |
| 50 mm | 2,2745 | 3,6539 | 5,0039 | 6,3833 | 30 | 360 |
| 60 mm | 3,4873 | 5,4730 | 7,6722 | 9,6578 | 20 | 240 |

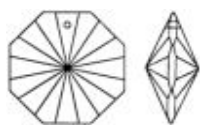

F.3401

| | | | | | | |
|-------|--------|--------|--------|--------|-----|-------|
| 20 mm | 0,3771 | 0,6272 | 0,8297 | 1,0798 | 420 | 5.040 |
| 22 mm | 0,4880 | 0,7669 | 1,0737 | 1,3526 | 300 | 3.600 |
| 24 mm | 0,5684 | 0,8968 | 1,2504 | 1,5788 | 240 | 2.880 |
| 26 mm | 0,6618 | 1,0552 | 1,4559 | 1,8494 | 200 | 2.400 |
| 28 mm | 0,7858 | 1,2436 | 1,7289 | 2,1866 | 150 | 1.800 |
| 30 mm | 0,8686 | 1,3819 | 1,9110 | 2,4243 | 125 | 1.500 |
| 32 mm | 0,9513 | 1,5078 | 2,0929 | 2,6493 | 100 | 1.200 |
| 34 mm | 1,1972 | 1,8103 | 2,6338 | 3,2470 | 80 | 960 |
| 36 mm | 1,3884 | 2,0565 | 3,0546 | 3,7227 | 80 | 960 |
| 38 mm | 1,5324 | 2,2947 | 3,3710 | 4,1333 | 80 | 960 |
| 40 mm | 1,7238 | 2,5909 | 3,7922 | 4,6594 | 80 | 960 |
| 50 mm | 2,2745 | 3,6539 | 5,0039 | 6,3833 | 30 | 360 |
| 60 mm | 3,4873 | 5,4730 | 7,6722 | 9,6578 | 20 | 240 |

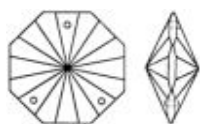

F.3403

| | | | | | | |
|-------|--------|--------|--------|--------|-----|-------|
| 22 mm | 0,5897 | 0,8686 | 1,2972 | 1,5762 | 300 | 3.600 |
| 40 mm | 2,1546 | 3,0217 | 4,7402 | 5,6073 | 80 | 960 |

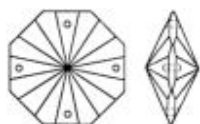

F.3404

| | | | | | | |
|-------|--------|--------|--------|--------|-----|-------|
| 22 mm | 0,5897 | 0,8686 | 1,2972 | 1,5762 | 300 | 3.600 |
| 40 mm | 2,1546 | 3,0217 | 4,7402 | 5,6073 | 80 | 960 |

| CRYSTAL | CRYSTAL coated | COLOR | COLOR coated | minimum quantity | |
|---------------|--|---|--|---------------------|------------------|
| CLEAR | AB AFLAME AMBER ANTIQUE GOLD SILVER | ALEXANDRITE AMETHYST AQUAMARINE EMERALD JET ROSA LIN RUBY SAPPHIRE SMOKE TOPAZ | AB AFLAME AMBER ANTIQUE GOLD SILVER | | |
| | BB BW OG OS VL VM | | BB BW OG OS VL VM | | |
| EURO piece | EURO piece | EURO piece | EURO piece | BOX pieces | CARTON pieces |

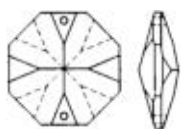

F.3300

| | | | | | | |
|-------|--------|--------|--------|--------|-------|--------|
| 10 mm | 0,0766 | 0,2293 | | | 3.300 | 39.600 |
| 12 mm | 0,0827 | 0,2354 | | | 2.200 | 26.400 |
| 14 mm | 0,0675 | 0,2061 | 0,2536 | 0,3878 | 1.800 | 21.600 |
| 16 mm | 0,1294 | 0,2856 | 0,3480 | 0,5042 | 900 | 10.800 |
| 18 mm | 0,2013 | 0,4004 | 0,5413 | 0,7404 | 640 | 7.680 |
| 20 mm | 0,2444 | 0,4945 | 0,6572 | 0,9073 | 420 | 5.040 |
| 22 mm | 0,3163 | 0,5952 | 0,7732 | 1,0521 | 300 | 3.600 |
| 24 mm | 0,4026 | 0,7310 | 0,9842 | 1,3126 | 240 | 2.880 |
| 26 mm | 0,4688 | 0,8622 | 1,1459 | 1,5393 | 200 | 2.400 |
| 28 mm | 0,5567 | 1,0144 | 1,3608 | 1,8186 | 150 | 1.800 |
| 30 mm | 0,6153 | 1,1286 | 1,5040 | 2,0174 | 125 | 1.500 |
| 32 mm | 0,6739 | 1,2303 | 1,6474 | 2,2038 | 100 | 1.200 |
| 34 mm | 0,9895 | 1,6026 | 2,1768 | 2,7900 | 80 | 960 |
| 36 mm | 1,1476 | 1,8157 | 2,5247 | 3,1928 | 80 | 960 |
| 38 mm | 1,3296 | 2,0920 | 2,9251 | 3,6875 | 80 | 960 |
| 40 mm | 1,5670 | 2,4342 | 3,4474 | 4,3145 | 80 | 960 |
| 50 mm | 2,0677 | 3,4471 | 4,5490 | 5,9284 | 30 | 360 |
| 60 mm | 3,1567 | 5,1423 | 6,9446 | 8,9302 | 20 | 240 |

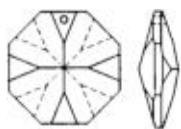

F.3301

| | | | | | | |
|-------|--------|--------|--------|--------|-------|--------|
| 10 mm | 0,0766 | 0,2293 | | | 3.300 | 39.600 |
| 12 mm | 0,0827 | 0,2354 | | | 2.200 | 26.400 |
| 14 mm | 0,0675 | 0,2061 | 0,2536 | 0,3878 | 1.800 | 21.600 |
| 16 mm | 0,1294 | 0,2856 | 0,3480 | 0,5042 | 900 | 10.800 |
| 18 mm | 0,2013 | 0,4004 | 0,5413 | 0,7404 | 640 | 7.680 |
| 20 mm | 0,2444 | 0,4945 | 0,6572 | 0,9073 | 420 | 5.040 |
| 22 mm | 0,3163 | 0,5952 | 0,7732 | 1,0521 | 300 | 3.600 |
| 24 mm | 0,4026 | 0,7310 | 0,9842 | 1,3126 | 240 | 2.880 |
| 26 mm | 0,4688 | 0,8622 | 1,1459 | 1,5393 | 200 | 2.400 |
| 28 mm | 0,5567 | 1,0144 | 1,3608 | 1,8186 | 150 | 1.800 |
| 30 mm | 0,6153 | 1,1286 | 1,5040 | 2,0174 | 125 | 1.500 |
| 32 mm | 0,6739 | 1,2303 | 1,6474 | 2,2038 | 100 | 1.200 |
| 34 mm | 0,9895 | 1,6026 | 2,1768 | 2,7900 | 80 | 960 |
| 36 mm | 1,1476 | 1,8157 | 2,5247 | 3,1928 | 80 | 960 |
| 38 mm | 1,3296 | 2,0920 | 2,9251 | 3,6875 | 80 | 960 |
| 40 mm | 1,5670 | 2,4342 | 3,4474 | 4,3145 | 80 | 960 |
| 50 mm | 2,0677 | 3,4471 | 4,5490 | 5,9284 | 30 | 360 |
| 60 mm | 3,1567 | 5,1423 | 6,9446 | 8,9302 | 20 | 240 |

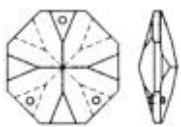

F.3303

| | | | | | | |
|-------|--------|--------|--------|--------|-------|--------|
| 14 mm | 0,2680 | 0,4022 | | | 1.800 | 21.600 |
| 18 mm | 0,3813 | 0,5803 | | | 640 | 7.680 |
| 22 mm | 0,4883 | 0,7672 | 1,0743 | 1,3532 | 300 | 3.600 |
| 40 mm | 1,8654 | 2,7326 | 4,1039 | 4,9711 | 80 | 960 |

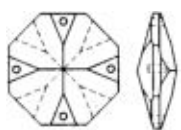

F.3304

| | | | | | | |
|-------|--------|--------|--------|--------|-------|--------|
| 14 mm | 0,2680 | 0,4022 | | | 1.800 | 21.600 |
| 16 mm | 0,1987 | 0,3230 | | | 900 | 10.800 |
| 18 mm | 0,3813 | 0,5803 | | | 640 | 7.680 |
| 22 mm | 0,4883 | 0,7672 | 1,0743 | 1,3532 | 300 | 3.600 |
| 40 mm | 1,8654 | 2,7326 | 4,1039 | 4,9711 | 80 | 960 |

| CRYSTAL | CRYSTAL <u>coated</u> | C O L O R | C O L O R <u>coated</u> | minimum quantity | |
|---------------|--|---|--|---------------------|------------------|
| CLEAR | AB AFLAME AMBER ANTIQUE GOLD SILVER | ALEXANDRITE AMETHYST AQUAMARINE EMERALD JET ROSA LIN RUBY SAPPHIRE SMOKE TOPAZ | AB AFLAME AMBER ANTIQUE GOLD SILVER | | |
| | BB BW OG OS VL VM | | BB BW OG OS VL VM | | |
| EURO piece | EURO piece | EURO piece | EURO piece | BOX pieces | CARTON pieces |



F.3240

| | | | | | | |
|-------|--------|--------|--------|--------|-----|--------|
| 14 mm | 0,1401 | 0,2470 | 0,2396 | 0,3886 | 900 | 10.800 |
| 18 mm | 0,2287 | 0,3789 | 0,3913 | 0,6101 | 400 | 4.800 |
| 22 mm | 0,3418 | 0,5399 | 0,5849 | 0,8855 | 210 | 2.520 |



F.3241

| | | | | | | |
|-------|--------|--------|--------|--------|-----|--------|
| 14 mm | 0,1401 | 0,2470 | 0,2396 | 0,3886 | 900 | 10.800 |
| 18 mm | 0,2287 | 0,3789 | 0,3913 | 0,6101 | 400 | 4.800 |
| 22 mm | 0,3418 | 0,5399 | 0,5849 | 0,8855 | 210 | 2.520 |

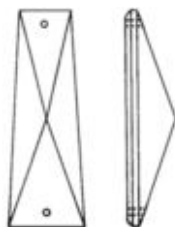

F.3260

| | | | | | | |
|-------------|--------|--------|--------|--------|-----|-------|
| 52x18x14 mm | 0,4998 | 1,1826 | 1,0995 | 1,7823 | 210 | 2.520 |
| 58x26x18 mm | 0,7688 | 1,9272 | 1,6914 | 2,8498 | 96 | 1.152 |
| 63x30x22 mm | 0,9804 | 2,2402 | 2,1570 | 3,4167 | 64 | 768 |

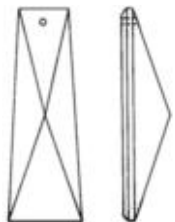

F.3261

| | | | | | | |
|-------------|--------|--------|--------|--------|-----|-------|
| 52x18x14 mm | 0,4998 | 1,1826 | 1,0995 | 1,7823 | 210 | 2.520 |
| 58x26x18 mm | 0,7688 | 1,9272 | 1,6914 | 2,8498 | 96 | 1.152 |
| 63x30x22 mm | 0,9804 | 2,2402 | 2,1570 | 3,4167 | 64 | 768 |

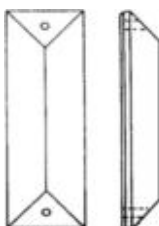

F.3270

| | | | | | | |
|-----------|--------|---------|---------|---------|-----|-------|
| 50x22 mm | 0,5491 | 1,2737 | 1,2081 | 1,9326 | 112 | 1.344 |
| 63x22 mm | 0,7688 | 1,7071 | 1,6914 | 2,6296 | 112 | 1.344 |
| 76x22 mm | 0,9804 | 2,0154 | 2,1570 | 3,1919 | 112 | 1.344 |
| 100x22 mm | 1,9896 | 3,3513 | 4,3771 | 5,7388 | 56 | 672 |
| 150x22 mm | 6,1319 | 11,6305 | 9,4208 | 14,9195 | 32 | 384 |
| 200x22 mm | 7,1831 | 16,1339 | 11,0427 | 19,9935 | 16 | 192 |

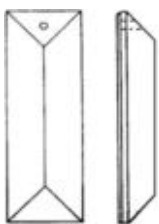

F.3271

| | | | | | | |
|-----------|---------|---------|---------|---------|-----|-------|
| 50x22 mm | 0,5491 | 1,2737 | 1,2081 | 1,9326 | 112 | 1.344 |
| 63x22 mm | 0,7688 | 1,7071 | 1,6914 | 2,6296 | 112 | 1.344 |
| 76x22 mm | 0,9804 | 2,0154 | 2,1570 | 3,1919 | 112 | 1.344 |
| 100x22 mm | 1,9896 | 3,3513 | 4,3771 | 5,7388 | 56 | 672 |
| 150x22 mm | 6,1319 | 11,6305 | 9,4208 | 14,9195 | 32 | 384 |
| 200x22 mm | 7,1831 | 16,1339 | 11,0427 | 19,9935 | 16 | 192 |
| 250x22 mm | 9,0227 | 19,9624 | | | 12 | 144 |
| 300x22 mm | 10,6387 | 24,7049 | | | 12 | 144 |
| 350x22 mm | 11,7160 | 31,3778 | | | 12 | 144 |
| 400x22 mm | 12,8944 | 34,7738 | | | 12 | 144 |
| 450x22 mm | 15,8907 | 40,5059 | | | 12 | 144 |
| 500x22 mm | 21,1428 | 49,2743 | | | 12 | 144 |

| CRYSTAL | CRYSTAL coated | COLOR | COLOR coated | minimum quantity | |
|------------|--|---|--|------------------|---------------|
| CLEAR | AB AFLAME AMBER ANTIQUE GOLD SILVER | ALEXANDRITE AMETHYST AQUAMARINE EMERALD JET ROSA LIN RUBY SAPPHIRE SMOKE TOPAZ | AB AFLAME AMBER ANTIQUE GOLD SILVER | | |
| | BB BW OG OS VL VM | | BB BW OG OS VL VM | | |
| EURO piece | EURO piece | EURO piece | EURO piece | BOX pieces | CARTON pieces |



F.3280

50x30 mm
76x30 mm
100x30 mm

0,6886 | 2,1352
1,1053 | 3,1290
2,4723 | 4,6701

72 | 864
60 | 720
24 | 288



F.3281

50x30 mm
76x30 mm
100x30 mm

0,6886 | 2,1352
1,1053 | 3,1290
2,4723 | 4,6701

72 | 864
60 | 720
24 | 288

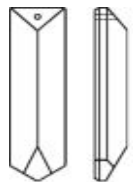

F.3250

63x18 mm
76x18 mm
89x18 mm
100x18 mm

0,6916 | 1,6300 | 1,5215 | 2,4599
0,9052 | 2,0372 | 1,9914 | 3,1234
1,2882 | 2,6137 | 2,8340 | 4,1595
1,9149 | 3,4043 | 4,2127 | 5,7022

128 | 1.536
128 | 1.536
64 | 768
64 | 768

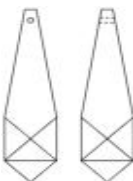

F.3245

76x18 mm

2,2776 | 3,3266

80 | 960

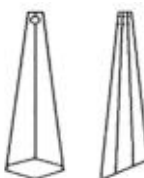

F.3215

63x16 mm
76x20 mm

0,9344 | 1,5888 | 1,6564 | 2,3108
1,2556 | 2,3047 | 2,2431 | 3,2922

175 | 2.100
100 | 1.200

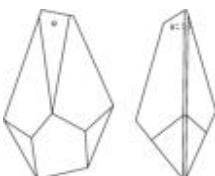

F.3205

50x33 mm
76x49 mm
100x65 mm

8,2343 | 9,3205
12,4974 | 14,3918
15,8933 | 21,8875

54 | 648
16 | 192
10 | 120

| CRYSTAL | CRYSTAL coated | C O L O R | C O L O R coated | minimum quantity | |
|---------------|--|---|--|---------------------|------------------|
| CLEAR | AB AFLAME AMBER ANTIQUE GOLD SILVER | ALEXANDRITE AMETHYST AQUAMARINE EMERALD JET ROSA LIN RUBY SAPPHIRE SMOKE TOPAZ | AB AFLAME AMBER ANTIQUE GOLD SILVER | | |
| | BB BW OG OS VL VM | | BB BW OG OS VL VM | | |
| EURO piece | EURO piece | EURO piece | EURO piece | BOX pieces | CARTON pieces |



F.3206

100x21 mm

1,4833

2,5782

24

288



F.3208

100x26 mm

5,8749

7,4008

24

288



F.3212

63x18 mm

1,7753

2,3457

100x28 mm

2,4347

3,9605

140

1.680

24

288



F.3214

63x16 mm

2,1613

2,7317

100x26 mm

2,5754

5,4701

140

1.680

24

288



F.3282

50x20 mm

1,1762

1,7718

63x26 mm

1,8945

3,0258

76x31 mm

2,4633

4,4856

140

1.680

60

720

40

480



F.3284

50x14 mm

1,6994

2,0923

76x22 mm

2,7176

3,8619

100x29 mm

3,2937

5,7468

125x35 mm

5,1537

9,0719

150

1.800

60

720

24

288

16

192

| CRYSTAL | CRYSTAL coated | COLOR | COLOR coated | minimum quantity | |
|---------------|--|---|--|---------------------|------------------|
| CLEAR | AB AFLAME AMBER ANTIQUE GOLD SILVER | ALEXANDRITE AMETHYST AQUAMARINE EMERALD JET ROSA LIN RUBY SAPPHIRE SMOKE TOPAZ | AB AFLAME AMBER ANTIQUE GOLD SILVER | | |
| | BB BW OG OS VL VM | | BB BW OG OS VL VM | | |
| EURO piece | EURO piece | EURO piece | EURO piece | BOX pieces | CARTON pieces |



F.3220

38x15 mm
50x18 mm
63x21 mm

| | | | | | |
|--------|--------|--------|--------|-----|-------|
| 0,3273 | 0,6936 | 0,9662 | 1,3325 | 240 | 2.880 |
| 0,6424 | 1,2171 | 1,3803 | 1,9550 | 90 | 1.080 |
| 0,9563 | 1,6107 | 2,0705 | 2,7249 | 72 | 864 |



F.3225

63x10 mm
100x20 mm

| | | | | | |
|--------|--------|--------|--------|-----|-------|
| 0,8468 | 1,3208 | 1,4494 | 1,9099 | 224 | 2.688 |
| 2,5696 | 3,6560 | 4,2445 | 5,3310 | 60 | 720 |



F.3226

63x15 mm
100x20 mm

| | | | | | |
|--------|--------|--------|--------|-----|-------|
| 2,1900 | 2,7604 | 4,3826 | 4,9530 | 175 | 2.100 |
| 2,8907 | 3,9772 | 5,9289 | 7,0154 | 60 | 720 |



F.3320

38x24 mm
50x29 mm

| | | | | | |
|--------|--------|--|--|----|-------|
| 1,8518 | 2,3781 | | | 96 | 1.152 |
| 2,6493 | 3,9087 | | | 36 | 432 |



F.3322

40x30 mm
50x40 mm



| | | | | | |
|--------|--------|--|--|----|-----|
| 1,1263 | 1,7334 | | | 18 | 216 |
| 1,5701 | 2,3585 | | | 15 | 180 |



F.3324

50x25 mm
76x35 mm

| | | | | | |
|---------|---------|--|--|----|-----|
| 8,4182 | 9,2055 | | | 36 | 432 |
| 14,4187 | 16,3132 | | | 20 | 240 |

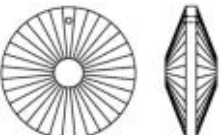
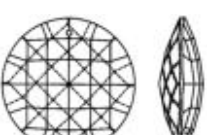
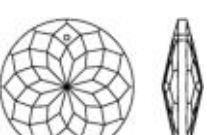
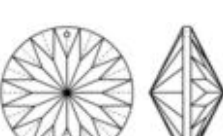
| | | CRYSTAL | CRYSTAL <u>coated</u> | C O L O R | C O L O R <u>coated</u> | minimum quantity | |
|---|----------------------------------|------------------|--|---|--|---------------------|------------------|
| | | CLEAR | AB AFLAME AMBER ANTIQUE GOLD SILVER | ALEXANDRITE AMETHYST AQUAMARINE EMERALD JET ROSA LIN RUBY SAPPHIRE SMOKE TOPAZ | AB AFLAME AMBER ANTIQUE GOLD SILVER | | |
| | | EURO piece | EURO piece | EURO piece | EURO piece | BOX pieces | CARTON pieces |
|  | F.3210 | | | | | | |
| | 20 mm | 1,0734 | 1,4809 | | | 144 | 1.728 |
| | 30 mm | 2,2670 | 2,9460 | | | 48 | 576 |
|  | F.3310 | | | | | | |
| | 40 mm | 3,7877 | 5,2075 | 4,5731 | 5,4012 | 40 | 480 |
|  | F.3676 | | | | | | |
| | 50 mm CH: 32mm 63 mm CH: 44mm | 2,9331 2,9783 | 4,7117 5,5335 | | | 72 30 | 864 360 |
|  | F.3344 | | | | | | |
| | 20 mm | 0,2168 | 0,6248 | | | 420 | 5.040 |
| | 30 mm | 0,4113 | 0,9248 | | | 150 | 1.800 |
| | 40 mm | 0,8477 | 1,6203 | | | 60 | 720 |
| | 50 mm | 2,2957 | 3,8248 | | | 48 | 576 |
|  | F.3342 | | | | | | |
| | 45 mm | 1,2994 | 2,1658 | | | 56 | 672 |
|  | F.3340 | | | | | | |
| | 45 mm | 1,5330 | 2,3994 | | | 56 | 672 |
|  | F.3228 | | | | | | |
| | 30 mm | 1,7082 | 2,2216 | 2,6572 | 3,1706 | 90 | 1.080 |
| | 40 mm | 2,2075 | 3,0742 | 3,6959 | 4,5625 | 42 | 504 |
| | 50 mm | 2,6980 | 4,0767 | 4,4619 | 5,8407 | 24 | 288 |
| | 60 mm | 4,5376 | 6,5231 | 7,5056 | 9,4911 | 16 | 192 |

| CRYSTAL | CRYSTAL coated | COLOR | COLOR coated | minimum quantity | |
|---------------|--|---|--|---------------------|------------------|
| CLEAR | AB AFLAME AMBER ANTIQUE GOLD SILVER | ALEXANDRITE AMETHYST AQUAMARINE EMERALD JET ROSA LIN RUBY SAPPHIRE SMOKE TOPAZ | AB AFLAME AMBER ANTIQUE GOLD SILVER | | |
| | BB BW OG OS VL VM | | BB BW OG OS VL VM | | |
| EURO piece | EURO piece | EURO piece | EURO piece | BOX pieces | CARTON pieces |



F.3350

20 mm
35 mm
50 mm

1,7228
2,3652
3,1535

2,1308
3,3071
4,6827

90
60
36

1.080
720
432



F.3351

20 mm
35 mm
50 mm

1,7228
2,3652
3,1535

2,1308
3,3071
4,6827

90
60
36

1.080
720
432



F.3352

20 mm
35 mm
50 mm

1,7228
2,3652
3,1535

2,1308
3,3071
4,6827

90
60
36

1.080
720
432



F.3353

20 mm
35 mm
50 mm

1,7228
2,3652
3,1535

2,1308
3,3071
4,6827

90
60
36

1.080
720
432

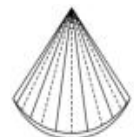

F.3217

25 mm
45 mm
65 mm

1,4016
2,3944
4,0295

2,0154
3,6098
6,9955

2,5191
4,2791
7,0742

3,1329
5,4945
10,0402

160
28
12

1.920
336
144



F.3216

38x22 mm
50x29 mm
63x37 mm

3,0659
3,5915
4,0295

3,6140
4,4968
5,4835

5,0727
5,9355
6,6601

5,6208
6,8408
8,1141

96
54
30

1.152
648
360



F.3328

40 mm
50 mm
60 mm

1,8980
2,3471
3,9479

2,7652
3,4879
5,9334

80
36
30

960
432
360

| CRYSTAL | CRYSTAL coated | COLOR | COLOR coated | minimum quantity | |
|---------------|--|---|--|---------------------|------------------|
| CLEAR | AB AFLAME AMBER ANTIQUE GOLD SILVER | ALEXANDRITE AMETHYST AQUAMARINE EMERALD JET ROSA LIN RUBY SAPPHIRE SMOKE TOPAZ | AB AFLAME AMBER ANTIQUE GOLD SILVER | | |
| | BB BW OG OS VL VM | | BB BW OG OS VL VM | | |
| EURO piece | EURO piece | EURO piece | EURO piece | BOX pieces | CARTON pieces |

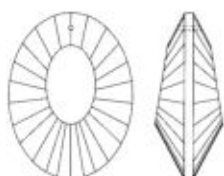

F.3361

50x35 mm
63x45 mm
76x55 mm

1,5534 | 2,5584
2,5550 | 4,2824
3,6616 | 5,9073

60 | 720
24 | 288
15 | 180

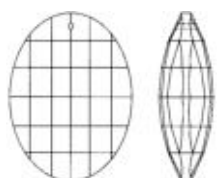

F.3365

50x35 mm
63x45 mm
76x55 mm

1,4162 | 2,4212
2,3885 | 4,1162
3,6295 | 5,8752

60 | 720
24 | 288
15 | 180

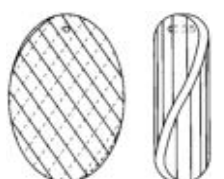

F.3371

45x30 mm
65x50 mm

1,7052 | 2,5658 | 3,6234
3,3171 | 5,1714 | 6,4876

4,4840 | 70 | 840
8,3420 | 24 | 288

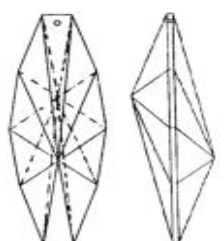

F.3327

38x19 mm
50x22 mm
63x26 mm
76x31 mm
89x36 mm
100x41 mm
125x46 mm

1,3140 | 1,8125 | 2,2431
1,6060 | 2,3649 | 2,7607
1,8396 | 2,9709 | 3,0367
2,5696 | 4,2227 | 4,2445
4,0295 | 6,3555 | 6,6601
4,9055 | 8,7427 | 8,6961
6,9495 | 11,5057 | 12,3195

2,7416 | 192 | 2.304
3,5196 | 120 | 1.440
4,1681 | 64 | 768
5,8977 | 36 | 432
8,9862 | 24 | 288
11,5431 | 21 | 252
16,8758 | 13 | 156

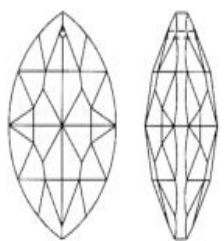

F.3337

38x22 mm
38x22 mm - 2 hole
50x29 mm
50x29 mm - 2 hole
63x35 mm
76x43 mm
89x53 mm
100x63 mm

0,7480 | 1,2462
0,7480 | 1,2462
1,5038 | 2,3276
1,5038 | 2,3276
2,4790 | 3,8112
3,8047 | 5,6995
4,3215 | 7,7334
7,2269 | 12,9164

192 | 2.304
192 | 2.304
90 | 1.080
90 | 1.080
45 | 540
24 | 288
10 | 120
6 | 72

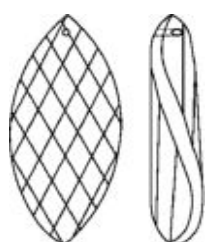

F.3347

38x19 mm
50x23 mm
63x27 mm
76x32 mm
89x37 mm
100x42 mm

0,9986 | 1,4971
1,1096 | 1,8966
1,6936 | 2,9249
2,5696 | 4,4640
4,2339 | 7,4879
5,1683 | 9,0055

192 | 2.304
98 | 1.176
75 | 900
60 | 720
24 | 288
18 | 216

| CRYSTAL | CRYSTAL coated | COLOR | COLOR coated | minimum quantity | |
|------------|--|---|--|------------------|---------------|
| CLEAR | AB AFLAME AMBER ANTIQUE GOLD SILVER | ALEXANDRITE AMETHYST AQUAMARINE EMERALD JET ROSA LIN RUBY SAPPHIRE SMOKE TOPAZ | AB AFLAME AMBER ANTIQUE GOLD SILVER | | |
| | BB BW OG OS VL VM | | BB BW OG OS VL VM | | |
| EURO piece | EURO piece | EURO piece | EURO piece | BOX pieces | CARTON pieces |

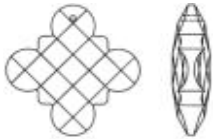

F.3291
50 mm

1,3829

3,1803

56

672

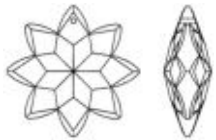

F.3293
50mm

2,1666

3,9639

36

432



F.3295
50mm

2,5462

4,3435

36

432



F.3227
43 mm

2,4727

3,6130

2,5881

3,7284

56

672

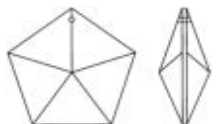

F.3223
50 mm

3,7472

5,1254

24

288

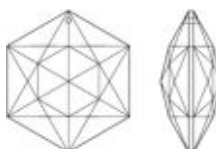

F.3221
50 mm

2,5462

4,3435

30

360

| CRYSTAL | CRYSTAL <u>coated</u> | C O L O R | C O L O R <u>coated</u> | minimum quantity | | |
|---------------|--|---|--|---------------------|------------------|--|
| CLEAR | AB AFLAME AMBER ANTIQUE GOLD SILVER | ALEXANDRITE AMETHYST AQUAMARINE EMERALD JET ROSA LIN RUBY SAPPHIRE SMOKE TOPAZ | AB AFLAME AMBER ANTIQUE GOLD SILVER | | | |
| | BB BW OG OS VL VM | | BB BW OG OS VL VM | | | |
| EURO piece | EURO piece | EURO piece | EURO piece | BOX pieces | CARTON pieces | |

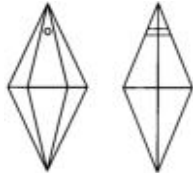

F.3377

50x25 mm
63x30 mm
76x35 mm

| | | | | | |
|--------|--------|---------|---------|----|-----|
| 3,7472 | 4,5345 | 6,8655 | 7,6528 | 54 | 648 |
| 4,6033 | 6,0286 | 8,4290 | 9,8543 | 45 | 540 |
| 5,7555 | 7,6503 | 10,5441 | 12,4389 | 16 | 192 |

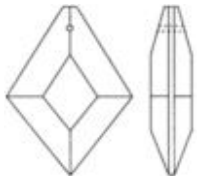

F.3380

63x40 mm
76x48 mm
89x57 mm

| | | | | | |
|--------|--------|--------|---------|----|-----|
| 1,3709 | 2,7071 | 3,0159 | 4,3520 | 60 | 720 |
| 2,0106 | 4,0768 | 4,4234 | 6,4896 | 32 | 384 |
| 3,1987 | 6,7442 | 7,0372 | 10,5826 | 20 | 240 |

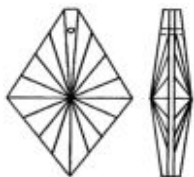

F.3386

63x40 mm
76x48 mm
89x57 mm

| | | | | | |
|--------|--------|--------|---------|----|-----|
| 1,8279 | 3,1637 | 4,0213 | 5,3571 | 45 | 540 |
| 2,4676 | 4,5337 | 5,4287 | 7,4949 | 24 | 288 |
| 3,7470 | 7,2925 | 8,2436 | 11,7890 | 15 | 180 |

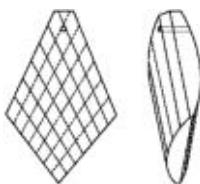

F.3213

63x40 mm
76x48 mm
89x57 mm

| | | | | | |
|--------|--------|--|--|----|-----|
| 1,8396 | 3,1751 | | | 70 | 840 |
| 2,5696 | 4,6356 | | | 32 | 384 |
| 4,5259 | 8,0714 | | | 18 | 216 |

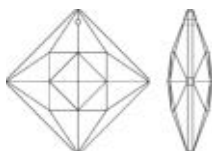

F.3238

30 mm
40 mm
50 mm

| | | | | | |
|--------|--------|--|--|----|-----|
| 0,8977 | 1,4523 | | | 70 | 840 |
| 1,2090 | 2,2390 | | | 56 | 672 |
| 1,9899 | 3,4786 | | | 30 | 360 |

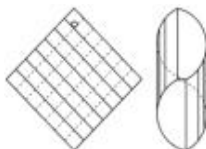

F.3218

30 mm
35 mm
40 mm

| | | | | | |
|--------|--------|--------|--------|----|-----|
| 1,6936 | 2,3031 | 2,6917 | 3,3012 | 70 | 840 |
| 2,1024 | 2,9222 | 3,3818 | 4,2016 | 56 | 672 |
| 2,2776 | 3,3076 | 3,6234 | 4,6534 | 56 | 672 |

| CRYSTAL | CRYSTAL coated | COLOR | COLOR coated | minimum quantity | |
|---------------|--|---|--|---------------------|------------------|
| CLEAR | AB AFLAME AMBER ANTIQUE GOLD SILVER | ALEXANDRITE AMETHYST AQUAMARINE EMERALD JET ROSA LIN RUBY SAPPHIRE SMOKE TOPAZ | AB AFLAME AMBER ANTIQUE GOLD SILVER | | |
| | BB BW OG OS VL VM | | BB BW OG OS VL VM | | |
| EURO piece | EURO piece | EURO piece | EURO piece | BOX pieces | CARTON pieces |

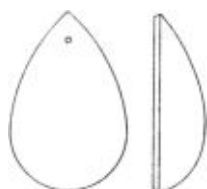

F.3229

| | | | | | | |
|-----------|---------|---------|--------|--------|-----|-------|
| 38x23 mm | 0,5483 | 1,0465 | 1,2064 | 1,7046 | 192 | 2.304 |
| 50x30 mm | 0,8225 | 1,8275 | 1,8094 | 2,8144 | 90 | 1.080 |
| 63x38 mm | 1,2795 | 2,6020 | 2,8148 | 4,1373 | 45 | 540 |
| 76x46 mm | 2,0106 | 3,9073 | 4,6245 | 6,5212 | 24 | 288 |
| 89x53 mm | 2,8332 | 6,2480 | | | 15 | 180 |
| 100x60 mm | 4,5696 | 10,4538 | | | 10 | 120 |
| 125x76 mm | 14,0744 | 22,4162 | | | 6 | 72 |
| 150x90 mm | 27,3013 | 36,2988 | | | 4 | 48 |

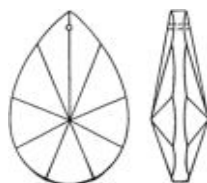

F.3230

| | | | | | | |
|-----------|---------|---------|--------|--------|-----|-------|
| 38x22 mm | 0,7268 | 1,2250 | 1,1198 | 1,6177 | 192 | 2.304 |
| 50x29 mm | 1,0188 | 2,0238 | 1,6857 | 2,6908 | 90 | 1.080 |
| 63x37 mm | 1,4568 | 2,7793 | 2,5830 | 3,9055 | 45 | 540 |
| 76x44 mm | 2,0992 | 3,9959 | 4,2670 | 6,1637 | 24 | 288 |
| 89x52 mm | 2,8724 | 6,2872 | | | 15 | 180 |
| 100x58 mm | 4,5184 | 10,4025 | | | 10 | 120 |
| 125x74 mm | 13,1870 | 21,5288 | | | 6 | 72 |
| 150x87 mm | 29,2394 | 38,2369 | | | 4 | 48 |

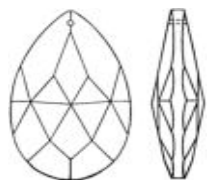

F.3420

| | | | | | | |
|-----------|---------|---------|--------|--------|-----|-------|
| 38x22 mm | 0,7551 | 1,2533 | 1,3217 | 1,8199 | 192 | 2.304 |
| 50x29 mm | 1,0413 | 2,0463 | 1,7068 | 2,7118 | 90 | 1.080 |
| 63x37 mm | 1,5289 | 2,8514 | 2,6199 | 3,9424 | 45 | 540 |
| 76x44 mm | 2,3377 | 4,2344 | 4,5586 | 6,4553 | 24 | 288 |
| 89x52 mm | 2,8724 | 6,4179 | | | 15 | 180 |
| 100x58 mm | 4,5184 | 10,4025 | | | 10 | 120 |
| 125x74 mm | 13,1870 | 21,5288 | | | 6 | 72 |
| 150x87 mm | 29,2394 | 38,2369 | | | 4 | 48 |

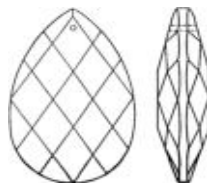

F.3430

| | | | | | | |
|-----------|---------|---------|--------|--------|-----|-------|
| 38x25 mm | 0,8398 | 1,3661 | 1,3745 | 1,9007 | 192 | 2.304 |
| 50x35 mm | 1,0880 | 2,0930 | 1,8645 | 2,8695 | 90 | 1.080 |
| 63x42 mm | 1,5464 | 2,8787 | 2,8583 | 4,1906 | 45 | 540 |
| 76x52 mm | 2,7027 | 4,7668 | 5,1083 | 7,0050 | 24 | 288 |
| 89x57 mm | 3,0465 | 6,4613 | | | 15 | 180 |
| 100x64 mm | 4,6611 | 10,5453 | | | 10 | 120 |
| 125x81 mm | 13,7814 | 22,1232 | | | 6 | 72 |
| 150x96 mm | 30,7843 | 39,7818 | | | 4 | 48 |

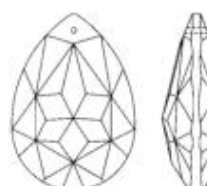

F.3440

| | | | | | | |
|----------|--------|--------|--|--|----|-------|
| 38x28 mm | 0,8398 | 1,3661 | | | 90 | 1.080 |
| 50x36 mm | 1,0880 | 2,0930 | | | 45 | 540 |
| 63x45 mm | 1,5464 | 2,8787 | | | 16 | 192 |
| 76x55 mm | 2,7027 | 4,7668 | | | 10 | 120 |

| CRYSTAL | CRYSTAL coated | COLOR | COLOR coated | minimum quantity | |
|---------------|--|---|--|---------------------|------------------|
| CLEAR | AB AFLAME AMBER ANTIQUE GOLD SILVER | ALEXANDRITE AMETHYST AQUAMARINE EMERALD JET ROSA LIN RUBY SAPPHIRE SMOKE TOPAZ | AB AFLAME AMBER ANTIQUE GOLD SILVER | | |
| | BB BW OG OS VL VM | | BB BW OG OS VL VM | | |
| EURO piece | EURO piece | EURO piece | EURO piece | BOX pieces | CARTON pieces |

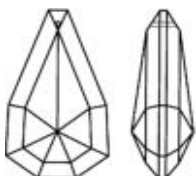

F.3384

50x30 mm
63x37 mm
76x44 mm

| | |
|--------|--------|
| 0,7533 | 1,7584 |
| 1,1884 | 2,6424 |
| 1,8279 | 3,7227 |

| | |
|----|-----|
| 72 | 864 |
| 45 | 540 |
| 24 | 288 |

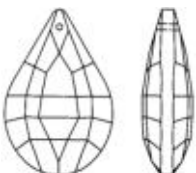

F.3385

50x32 mm
63x40 mm
76x48 mm

| | |
|--------|--------|
| 1,1435 | 2,1485 |
| 1,8498 | 3,1856 |
| 2,7027 | 4,5975 |

| | |
|----|-----|
| 72 | 864 |
| 45 | 540 |
| 24 | 288 |

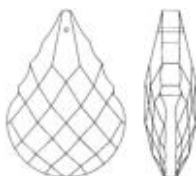

F.3387

50x34 mm
63x43 mm
76x52 mm

| | |
|--------|--------|
| 1,5038 | 2,5088 |
| 2,4790 | 3,8242 |
| 3,8047 | 6,0504 |

| | |
|----|-----|
| 72 | 864 |
| 45 | 540 |
| 24 | 288 |

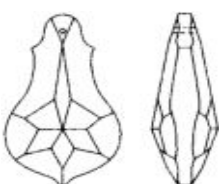

F.3388

50x30 mm
63x37 mm
76x44 mm
89x52 mm
100x60 mm
125x74 mm
150x88 mm

| | |
|---------|---------|
| 0,7533 | 1,7584 |
| 1,1884 | 2,5245 |
| 1,8279 | 3,7227 |
| 3,5615 | 7,1066 |
| 6,3158 | 14,6323 |
| 10,8985 | 20,1579 |
| 22,7253 | 32,2649 |

| | |
|----|-------|
| 90 | 1.080 |
| 45 | 540 |
| 24 | 288 |
| 15 | 180 |
| 10 | 120 |
| 6 | 72 |
| 4 | 48 |

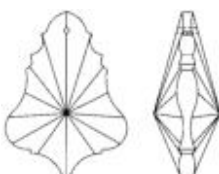

F.3389

50x35 mm
63x45 mm
76x55 mm

| | |
|--------|--------|
| 1,5038 | 2,5088 |
| 2,4790 | 3,8242 |
| 3,8047 | 6,0504 |

| | |
|----|-----|
| 72 | 864 |
| 45 | 540 |
| 16 | 192 |

| CRYSTAL | CRYSTAL coated | COLOR | COLOR coated | minimum quantity | |
|------------|--|---|--|------------------|---------------|
| CLEAR | AB AFLAME AMBER ANTIQUE GOLD SILVER | ALEXANDRITE AMETHYST AQUAMARINE EMERALD JET ROSA LIN RUBY SAPPHIRE SMOKE TOPAZ | AB AFLAME AMBER ANTIQUE GOLD SILVER | | |
| | BB BW OG OS VL VM | | BB BW OG OS VL VM | | |
| EURO piece | EURO piece | EURO piece | EURO piece | BOX pieces | CARTON pieces |

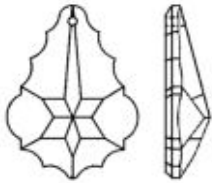

F.3390

38x26 mm
50x34 mm
63x43 mm
76x52 mm
89x60 mm
100x68 mm
125x86 mm
150x106 mm
200x141 mm

| | | | | | |
|---------|---------|----------|----------|-----|-------|
| 0,6913 | 1,2745 | 1,1664 | 1,7495 | 192 | 2.304 |
| 0,7767 | 1,7817 | 1,6530 | 2,6580 | 84 | 1.008 |
| 1,0687 | 2,4092 | 2,2741 | 3,6146 | 70 | 840 |
| 1,7169 | 3,8516 | 3,6510 | 5,7856 | 48 | 576 |
| 2,8090 | 6,3570 | 5,9769 | 9,5249 | 24 | 288 |
| 3,1857 | 8,2692 | 22,3184 | 27,4020 | 12 | 144 |
| 4,2573 | 13,0299 | 26,0096 | 34,7822 | 9 | 108 |
| 31,6908 | 46,6816 | 53,7445 | 68,7353 | 6 | 72 |
| 56,9469 | 78,4867 | 107,6994 | 129,2392 | 2 | 24 |

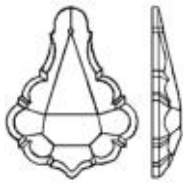

F.3393

63x47 mm
76x57 mm
89x67 mm
100x77 mm

| | | | | | |
|--------|--------|--------|---------|----|-----|
| 0,7767 | 2,1174 | 2,4501 | 4,1546 | 60 | 720 |
| 1,5826 | 3,7172 | 4,0133 | 6,1479 | 30 | 360 |
| 1,8629 | 5,8596 | 5,5214 | 9,5181 | 30 | 360 |
| 2,2279 | 9,4591 | 6,5566 | 11,9561 | 16 | 192 |

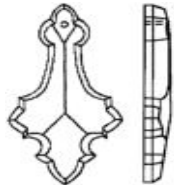

F.3392

63x32 mm
76x39 mm
89x45 mm
100x50 mm

| | | | | | |
|--------|--------|--------|--------|----|-------|
| 0,6862 | 1,8798 | 1,8635 | 3,0570 | 90 | 1.080 |
| 1,1943 | 3,0908 | 3,1748 | 5,0714 | 60 | 720 |
| 1,4308 | 4,4268 | 3,7269 | 6,7229 | 60 | 720 |
| 1,6936 | 5,5338 | 4,2100 | 8,0502 | 30 | 360 |



F.3394

76x30 mm
100x40 mm

| | | | | | |
|--------|--------|--------|--------|----|-----|
| 1,3782 | 3,2748 | 3,6510 | 5,5476 | 50 | 600 |
| 1,9476 | 5,7878 | 4,8415 | 8,6817 | 24 | 288 |

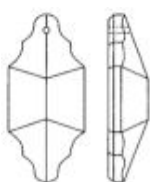

F.3396

63x30 mm

| | | | | | |
|--------|--------|--------|--------|----|-----|
| 0,7592 | 2,1843 | 2,0360 | 3,4611 | 60 | 720 |
|--------|--------|--------|--------|----|-----|

| CRYSTAL | CRYSTAL coated | COLOR | COLOR coated | minimum quantity | |
|------------|--|---|--|------------------|---------------|
| CLEAR | AB AFLAME AMBER ANTIQUE GOLD SILVER | ALEXANDRITE AMETHYST AQUAMARINE EMERALD JET ROSA LIN RUBY SAPPHIRE SMOKE TOPAZ | AB AFLAME AMBER ANTIQUE GOLD SILVER | | |
| | BB BW OG OS VL VM | | BB BW OG OS VL VM | | |
| EURO piece | EURO piece | EURO piece | EURO piece | BOX pieces | CARTON pieces |

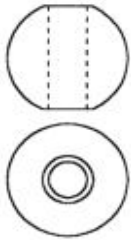

F.3710

center hole: 13 mm

| | | | | |
|--------|---------|---------|----|-----|
| 40 mm | 4,0529 | 6,2253 | 20 | 240 |
| 50 mm | 6,2253 | 9,3656 | 10 | 120 |
| 60 mm | 6,8560 | 11,3429 | 5 | 60 |
| 70 mm | 9,5366 | 15,7773 | 1 | 36 |
| 80 mm | 10,5965 | 18,7830 | 1 | 36 |
| 90 mm | 16,1298 | 28,5937 | 1 | 27 |
| 100 mm | 17,9226 | 31,7720 | 1 | 27 |

AMETHYST + AQUAMARINE + SMOKE + RUBY :
available only in the sizes 40mm + 50mm !

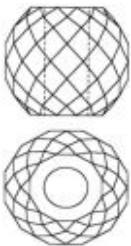

F.3720

center hole: 13 mm

| | | | | |
|-------|---------|---------|----|-----|
| 40 mm | 6,2779 | 14,8386 | 20 | 240 |
| 50 mm | 8,6138 | 20,3600 | 10 | 120 |
| 60 mm | 10,7454 | | 10 | 120 |

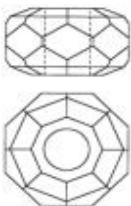

F.3730

center hole: 13 mm

| | | | | | | |
|----------|--------|--------|---------|---------|----|-----|
| 40x24 mm | 4,8179 | 5,6459 | 11,3878 | 12,2157 | 40 | 480 |
| 50x30 mm | 6,6575 | 7,9746 | 15,7359 | 17,2902 | 20 | 240 |
| 60x35 mm | 7,8755 | 8,8227 | | | 10 | 120 |

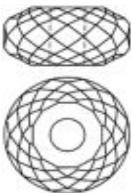

F.3740

center hole: 13 mm

| | | | | | | |
|----------|--------|---------|--|--|----|-----|
| 40x20 mm | 4,9823 | 5,8102 | | | 40 | 480 |
| 50x25 mm | 6,9752 | 8,2923 | | | 20 | 240 |
| 60x30 mm | 8,3986 | 10,3303 | | | 10 | 120 |

| CRYSTAL | CRYSTAL coated | COLOR | COLOR coated | minimum quantity | |
|------------|--|---|--|------------------|---------------|
| CLEAR | AB AFLAME AMBER ANTIQUE GOLD SILVER | ALEXANDRITE AMETHYST AQUAMARINE EMERALD JET ROSA LIN RUBY SAPPHIRE SMOKE TOPAZ | AB AFLAME AMBER ANTIQUE GOLD SILVER | | |
| | BB BW OG OS VL VM | | BB BW OG OS VL VM | | |
| EURO piece | EURO piece | EURO piece | EURO piece | BOX pieces | CARTON pieces |

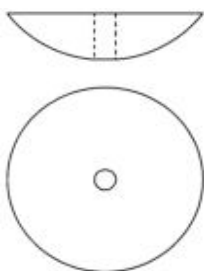

F.3855

| center hole: | 13 mm | 11 mm | | | |
|--------------------------|--------|---------|---------|---------|-----|
| 70x20 mm | 6,2570 | 16,8379 | 15,5288 | 24,2450 | 12 |
| 100x23 mm | 8,8316 | 31,9702 | 21,3953 | 40,0789 | 144 |
| drilling of extra SH : | 0,3800 | | 0,3800 | | 9 |
| stud-insertion into SH : | | | | | |
| BRASS | 0,0900 | | 0,0900 | | |
| CHROME-PLATED | 0,1000 | | 0,1000 | | |
| GOLD-PLATED | 0,1200 | | 0,1200 | | |

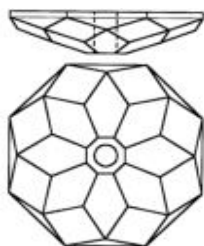

F.3851

| center hole: | 13 mm | 11 mm | | | |
|--------------------------|--------|---------|---------|---------|-----|
| 70x20 mm | 6,2570 | 16,8379 | 15,5288 | 24,2450 | 12 |
| 100x23 mm | 8,8316 | 31,9702 | 21,3953 | 40,0789 | 144 |
| drilling of extra SH : | 0,3800 | | 0,3800 | | 9 |
| stud-insertion into SH : | | | | | |
| BRASS | 0,0900 | | 0,0900 | | |
| CHROME-PLATED | 0,1000 | | 0,1000 | | |
| GOLD-PLATED | 0,1200 | | 0,1200 | | |

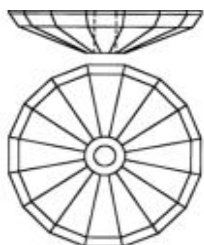

F.3850

| center hole: | 13 mm | 11 mm | | | |
|--------------------------|--------|---------|---------|---------|-----|
| 70x20 mm | 6,2570 | 16,8379 | 15,5288 | 24,2450 | 12 |
| 100x23 mm | 8,8316 | 31,9702 | 21,3953 | 40,0789 | 144 |
| drilling of extra SH : | 0,3800 | | 0,3800 | | 9 |
| stud-insertion into SH : | | | | | |
| BRASS | 0,0900 | | 0,0900 | | |
| CHROME-PLATED | 0,1000 | | 0,1000 | | |
| GOLD-PLATED | 0,1200 | | 0,1200 | | |



CLASSIC



CLASSIC

optic crystal

classic brilliance

hand-cut

historic shapes

pinning service available

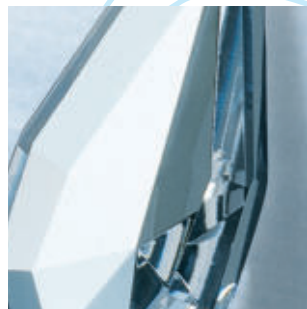

Schöler & Co. GmbH

Gablonzer Strasse 54-61
A-4550 Kremsmünster
Austria

T: ++43-75 83-77 23

F: ++43-75 83-78 12

E: office@scholer-crystal.at

W: www.scholer-crystal.at



ARTICLE INDEX





























| Article: | Page: | Article: | Page: | Article: | Page: | Article: | Page: | Article: | Page: |
|-----------------|--------------|-----------------|--------------|-----------------|--------------|-----------------|--------------|-----------------|--------------|
| C.0196 | 83 | C.0262 | 22 | C.0342 | 25 | C.0423 | 27 | C.0508 | 52 |
| C.0197 | 82 | C.0263 | 8 | C.0344 | 15 | C.0424 | 13 | C.0509 | 52 |
| C.0198 | 82 | C.0264 | 8 | C.0345 | 25 | C.0425 | 29 | C.0510 | 52 |
| C.0199 | 82 | C.0272 | 59 | C.0346 | 45 | C.0426 | 48 | C.0511 | 52 |
| C.0202 | 78 | C.0274 | 59 | C.0347 | 46 | C.0428 | 40 | C.0512 | 36 |
| C.0203 | 12 | C.0275 | 43 | C.0348 | 46 | C.0429 | 48 | C.0515 | 65 |
| C.0204 | 7 | C.0276 | 59+70 | C.0349 | 28 | C.0430 | 40 | C.0516 | 53 |
| C.0205 | 18 | C.0277 | 24 | C.0350 | 70 | C.0432 | 41 | C.0517 | 65 |
| C.0206 | 18 | C.0278 | 74 | C.0351 | 33 | C.0433 | 34 | C.0518 | 53 |
| C.0207 | 42 | C.0279 | 76 | C.0352 | 16 | C.0436 | 26 | C.0529 | 31 |
| C.0208 | 42 | C.0280 | 60 | C.0353 | 33 | C.0439 | 48 | C.0530 | 30 |
| C.0209 | 56 | C.0281 | 60 | C.0354 | 46 | C.0440 | 62 | C.0531 | 30 |
| C.0210 | 56 | C.0282 | 60 | C.0355 | 21 | C.0441 | 63 | C.0533 | 79 |
| C.0211 | 56 | C.0283 | 14 | C.0356 | 33 | C.0443 | 49 | C.0536 | 27 |
| C.0212 | 56 | C.0284 | 14 | C.0357 | 22 | C.0444 | 26 | C.0537 | 35 |
| C.0213 | 22 | C.0285 | 74 | C.0358 | 23 | C.0447 | 41 | C.0541 | 35 |
| C.0214 | 24 | C.0286 | 13 | C.0359 | 16 | C.0449 | 49 | C.0550 | 66 |
| C.0215 | 57 | C.0287 | 75 | C.0360 | 61+73 | C.0450 | 15 | C.0551 | 35 |
| C.0216 | 57 | C.0288 | 32 | C.0361 | 46 | C.0452 | 49 | C.0552 | 66 |
| C.0217 | 57 | C.0289 | 60 | C.0362 | 46 | C.0453 | 37 | C.0553 | 77 |
| C.0218 | 57 | C.0290 | 76 | C.0365 | 8 | C.0454 | 37 | C.0554 | 77 |
| C.0219 | 42 | C.0291 | 44 | C.0366 | 61 | C.0455 | 63 | C.0555 | 16 |
| C.0220 | 71 | C.0292 | 31 | C.0367 | 46 | C.0456 | 63 | C.0556 | 35 |
| C.0221 | 72 | C.0293 | 28 | C.0369 | 11 | C.0457 | 63 | C.0557 | 77 |
| C.0222 | 43 | C.0294 | 79 | C.0370 | 33 | C.0458 | 11 | C.0558 | 66 |
| C.0223 | 22 | C.0295 | 44 | C.0371 | 8 | C.0459 | 64 | C.0559 | 66 |
| C.0224 | 27 | C.0296 | 76 | C.0372 | 11 | C.0460 | 64 | C.0560 | 67 |
| C.0225 | 58 | C.0297 | 75 | C.0373 | 11 | C.0461 | 26 | C.0561 | 67 |
| C.0226 | 12 | C.0298 | 84 | C.0374 | 11 | C.0462 | 64 | C.0562 | 67 |
| C.0227 | 72 | C.0299 | 84 | C.0375 | 61+73 | C.0463 | 81 | C.0563 | 67 |
| C.0228 | 72 | C.0301 | 44 | C.0376 | 61 | C.0464 | 81 | C.0564 | 68 |
| C.0229 | 31 | C.0302 | 79 | C.0378 | 39 | C.0465 | 49 | C.0565 | 68 |
| C.0230 | 9 | C.0305 | 73 | C.0381 | 47 | C.0466 | 49 | C.0566 | 68 |
| C.0231 | 58 | C.0307 | 39 | C.0382 | 47 | C.0467 | 49 | C.0567 | 68 |
| C.0232 | 24 | C.0308 | 39 | C.0383 | 47 | C.0468 | 50 | C.0568 | 17 |
| C.0233 | 32 | C.0309 | 44 | C.0384 | 62 | C.0469 | 64 | C.0569 | 69 |
| C.0234 | 37 | C.0310 | 29 | C.0385 | 47 | C.0470 | 50 | C.0570 | 69 |
| C.0235 | 43 | C.0311 | 44 | C.0386 | 39 | C.0471 | 11 | C.0571 | 69 |
| C.0236 | 79 | C.0312 | 44 | C.0387 | 47 | C.0472 | 50 | C.0572 | 69 |
| C.0237 | 58 | C.0313 | 45 | C.0388 | 16 | C.0473 | 65 | C.0574 | 53 |
| C.0238 | 43 | C.0316 | 33 | C.0389 | 47 | C.0474 | 26 | C.0587 | 53 |
| C.0239 | 58 | C.0317 | 79 | C.0394 | 80 | C.0475 | 81 | C.0589 | 53 |
| C.0240 | 79 | C.0319 | 45 | C.0395 | 39 | C.0478 | 28 | C.0594 | 53 |
| C.0241 | 9 | C.0320 | 45 | C.0397 | 23 | C.0480 | 28 | C.0595 | 54 |
| C.0242 | 71 | C.0322 | 12 | C.0400 | 34 | C.0485 | 35 | C.0596 | 54 |
| C.0243 | 14 | C.0323 | 73 | C.0402 | 80 | C.0486 | 39 | C.0597 | 54 |
| C.0244 | 14 | C.0324 | 70 | C.0403 | 48 | C.0487 | 15 | C.0598 | 54 |
| C.0245 | 7 | C.0325 | 13 | C.0404 | 62 | C.0489 | 15 | C.0599 | 54 |
| C.0246 | 30 | C.0327 | 27 | C.0405 | 62 | C.0490 | 50 | C.0600 | 54 |
| C.0248 | 40 | C.0328 | 83 | C.0408 | 48 | C.0491 | 50 | C.0724 | 70 |
| C.0249 | 31 | C.0329 | 79 | C.0409 | 34 | C.0492 | 65 | C.0801 | 19 |
| C.0250 | 40 | C.0330 | 45 | C.0410 | 37 | C.0494 | 50 | C.0802 | 19 |
| C.0251 | 40 | C.0331 | 45 | C.0411 | 15 | C.0495 | 51 | C.0803 | 19 |
| C.0252 | 41 | C.0333 | 24 | C.0412 | 48 | C.0496 | 51 | C.0804 | 19 |
| C.0253 | 59 | C.0334 | 21 | C.0413 | 80 | C.0497 | 51 | C.0805 | 19 |
| C.0254 | 40 | C.0335 | 16 | C.0414 | 38 | C.0501 | 51 | C.0821 | 20 |
| C.0255 | 55 | C.0336 | 25 | C.0415 | 38 | C.0502 | 36 | C.0822 | 20 |
| C.0256 | 55 | C.0337 | 21 | C.0416 | 21 | C.0503 | 51 | C.0823 | 20 |
| C.0257 | 55 | C.0338 | 21 | C.0417 | 38 | C.0504 | 52 | C.9041 | 80+81 |
| C.0259 | 10 | C.0339 | 10 | C.0418 | 38 | C.0505 | 21 | C.9042 | 80+81 |
| C.0260 | 32 | C.0340 | 14 | C.0419 | 34 | C.0506 | 26 | C.9043 | 80 |
| C.0261 | 32 | C.0341 | 25 | C.0420 | 34 | C.0507 | 52 | | |

QUALITY:

Ia = full-cut

Ib = half-cut (f.e. only the largest facet)

PRODUCT GROUP

| | | <u>Page:</u> | | | <u>Page:</u> |
|------------------|---|--------------|-------------------|---|--------------|
| OCTAGONS |  | 7 - 9 | DECORATION STONES |  | 40 |
| ROUNDS |  | 10 - 11 | HEART STONES |  | 41 |
| OVALS |  | 12 | ALMONDS |  | 42 - 54 |
| SQUARE STONES |  | 13 | TWO-HOLE ALMONDS |  | 55 |
| DISTRIBUTORS |  | 14 - 17 | PENDELOQUES |  | 56 - 69 |
| BALLS & BELLS |  | 18 - 20 | FRUITS & LEAVES |  | 70 - 71 |
| FINIALS |  | 21 | CROWNS |  | 72 - 73 |
| ICICLES |  | 22 - 23 | SPIKES |  | 74 - 77 |
| PRISMS |  | 24 - 26 | ROSETTES |  | 78 |
| POINTED STONES |  | 27 - 29 | STARS |  | 79 |
| ALBERTS |  | 30 - 31 | CLAMP STONES |  | 80 - 81 |
| RECTANGLE STONES |  | 32 - 36 | BEADS |  | 82 |
| COFFIN STONES |  | 37 | CENTERPIECES |  | 83 |
| SPECIAL STONES |  | 38 - 39 | BOBECHES |  | 84 |

| CRYSTAL | CRYSTAL <u>coated</u> | C O L O R | C O L O R <u>coated</u> | minimum quantity |
|---------------|--|---|--|---------------------|
| CLEAR | AB AFLAME AMBER ANTIQUÉ GOLD SILVER | ALEXANDRITE AMETHYST AQUAMARINE EMERALD JET ROSA LIN RUBY SAPPHIRE SMOKE TOPAZ | AB AFLAME AMBER ANTIQUÉ GOLD SILVER | |
| EURO piece | BB BW OG OS VL VM EURO piece | EURO piece | BB BW OG OS VL VM EURO piece | pieces |

OCTAGONS

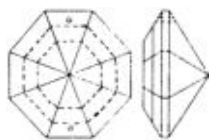

C.0204 lb

| | | | |
|-------|--------|--------|-----|
| 14 mm | 0,6874 | 0,8592 | 500 |
| 16 mm | 1,1763 | 1,4704 | 250 |
| 18 mm | 1,3202 | 1,6501 | 250 |
| 20 mm | 1,4596 | 1,8247 | 250 |
| 22 mm | 1,9029 | 2,3788 | 250 |
| 24 mm | 1,9896 | 2,4872 | 250 |
| 26 mm | 2,1680 | 2,7100 | 250 |
| 28 mm | 2,4778 | 3,0971 | 250 |
| 30 mm | 2,9649 | 3,7062 | 100 |
| 32 mm | 3,2125 | 4,0157 | 100 |

C.0204 la

| | | | |
|-------|---------|---------|----|
| 34 mm | 7,4386 | 9,2984 | 50 |
| 36 mm | 8,1258 | 10,1574 | 50 |
| 38 mm | 8,8835 | 11,1044 | 50 |
| 40 mm | 9,2704 | 11,5879 | 50 |
| 45 mm | 11,2816 | 14,1021 | 50 |
| 50 mm | 13,1341 | 16,4176 | 25 |
| 55 mm | 15,8423 | 19,8028 | 25 |

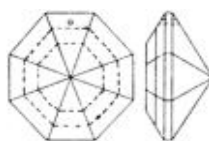

C.0245 lb

| | | | |
|-------|--------|--------|-----|
| 22 mm | 1,9029 | 2,3788 | 250 |
| 24 mm | 1,9896 | 2,4872 | 250 |
| 26 mm | 2,1680 | 2,7100 | 250 |

C.0245 la

| | | | |
|-------|---------|---------|----|
| 34 mm | 7,4386 | 9,2984 | 50 |
| 36 mm | 8,1258 | 10,1574 | 50 |
| 38 mm | 8,8835 | 11,1044 | 50 |
| 40 mm | 9,2704 | 11,5879 | 50 |
| 45 mm | 11,2816 | 14,1021 | 50 |
| 50 mm | 13,1341 | 16,4176 | 25 |
| 55 mm | 15,8423 | 19,8028 | 25 |

| CRYSTAL | CRYSTAL coated | COLOR | COLOR coated | minimum quantity |
|---------------|--|--|--|---------------------|
| CLEAR | AB AFLAME AMBER ANTIQUÉ GOLD SILVER | ALEXANDRITE AMETHYST AQUAMARINE EMERALD JET ROSALIN RUBY SAPPHIRE SMOKE TOPAZ | AB AFLAME AMBER ANTIQUÉ GOLD SILVER | |
| EURO piece | BB BW OG OS VL VM EURO piece | EURO piece | BB BW OG OS VL VM EURO piece | pieces |

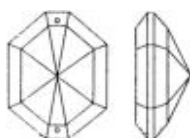

C.0263 la
48x35 mm

11,2175

14,0218

50

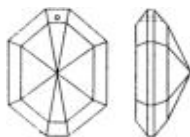

C.0264 la
48x35 mm

11,2175

14,0218

50

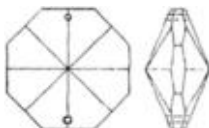

C.0365 la
40 mm
50 mm
60 mm

9,3687
15,1589
22,7029

11,7110
18,9485
28,3785

50
25
25

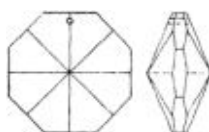

C.0371 la
40 mm
50 mm
60 mm

9,3687
15,1589
22,7029

11,7110
18,9485
28,3785

50
25
25

| CRYSTAL | CRYSTAL <u>coated</u> | C O L O R | C O L O R <u>coated</u> | minimum quantity |
|---------------|--|--|--|---------------------|
| CLEAR | AB AFLAME AMBER ANTIQUÉ GOLD SILVER | ALEXANDRITE AMETHYST AQUAMARINE EMERALD JET ROSALIN RUBY SAPPHIRE SMOKE TOPAZ | AB AFLAME AMBER ANTIQUÉ GOLD SILVER | |
| EURO piece | EURO piece | EURO piece | EURO piece | pieces |

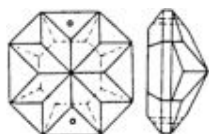

C.0230 lb

| | | | |
|-------|--------|--------|-----|
| 12 mm | 0,8219 | 1,0273 | 250 |
| 14 mm | 0,8507 | 1,0632 | 250 |
| 16 mm | 0,9858 | 1,2324 | 250 |
| 18 mm | 1,0425 | 1,3031 | 250 |
| 20 mm | 1,1877 | 1,4847 | 250 |
| 22 mm | 1,3577 | 1,6973 | 250 |
| 24 mm | 1,6504 | 2,0631 | 250 |
| 26 mm | 1,8432 | 2,3039 | 250 |
| 28 mm | 2,0943 | 2,6177 | 250 |
| 30 mm | 2,5212 | 3,1515 | 100 |
| 32 mm | 2,9006 | 3,6257 | 100 |

C.0230 la

| | | | |
|-------|---------|---------|-----|
| 18 mm | 2,2400 | 2,7999 | 100 |
| 20 mm | 2,5644 | 3,2054 | 100 |
| 22 mm | 2,8084 | 3,5103 | 100 |
| 24 mm | 3,1480 | 3,9351 | 100 |
| 26 mm | 3,4956 | 4,3693 | 100 |
| 28 mm | 4,1093 | 5,1364 | 100 |
| 30 mm | 4,9176 | 6,1471 | 100 |
| 32 mm | 5,4747 | 6,8434 | 100 |
| 34 mm | 6,3567 | 7,9458 | 50 |
| 36 mm | 6,8401 | 8,5502 | 50 |
| 38 mm | 7,4897 | 9,3621 | 50 |
| 40 mm | 7,8879 | 9,8600 | 50 |
| 45 mm | 9,2307 | 11,5383 | 50 |
| 50 mm | 12,1201 | 15,1501 | 50 |
| 55 mm | 18,2350 | 22,7936 | 25 |
| 60 mm | 20,3139 | 25,3926 | 25 |
| 65 mm | 24,4101 | 30,5128 | 25 |
| 70 mm | 35,9221 | 44,9025 | 25 |

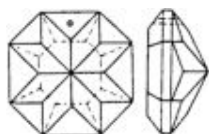

C.0241 lb

| | | | |
|-------|--------|--------|-----|
| 16 mm | 0,9858 | 1,2324 | 250 |
| 20 mm | 1,1877 | 1,4847 | 250 |
| 22 mm | 1,3577 | 1,6973 | 250 |
| 24 mm | 1,6504 | 2,0631 | 250 |
| 26 mm | 1,8432 | 2,3039 | 250 |
| 28 mm | 2,0943 | 2,6177 | 250 |
| 30 mm | 2,5212 | 3,1515 | 100 |
| 32 mm | 2,9006 | 3,6257 | 100 |

C.0241 la

| | | | |
|-------|---------|---------|-----|
| 26 mm | 3,4956 | 4,3693 | 100 |
| 28 mm | 4,1093 | 5,1364 | 100 |
| 30 mm | 4,9176 | 6,1471 | 100 |
| 32 mm | 5,4747 | 6,8434 | 100 |
| 34 mm | 6,3567 | 7,9458 | 50 |
| 36 mm | 6,8401 | 8,5502 | 50 |
| 38 mm | 7,4897 | 9,3621 | 50 |
| 40 mm | 7,8879 | 9,8600 | 50 |
| 45 mm | 9,2307 | 11,5383 | 50 |
| 50 mm | 12,1201 | 15,1501 | 50 |
| 55 mm | 18,2350 | 22,7936 | 25 |
| 60 mm | 20,3139 | 25,3926 | 25 |
| 65 mm | 24,4101 | 30,5128 | 25 |
| 70 mm | 35,9221 | 44,9025 | 25 |

| CRYSTAL | CRYSTAL <u>coated</u> | C O L O R | C O L O R <u>coated</u> | minimum quantity |
|---------------|--|--|--|---------------------|
| CLEAR | AB AFLAME AMBER ANTIQUÉ GOLD SILVER | ALEXANDRITE AMETHYST AQUAMARINE EMERALD JET ROSALIN RUBY SAPPHIRE SMOKE TOPAZ | AB AFLAME AMBER ANTIQUÉ GOLD SILVER | |
| | BB BW OG OS VL VM | | BB BW OG OS VL VM | |
| EURO piece | EURO piece | EURO piece | EURO piece | pieces |

ROUNDS

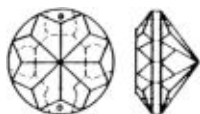

C.0259 Ib

| | | | |
|-------|--------|--------|-----|
| 14 mm | 1,3804 | 1,7255 | 250 |
| 16 mm | 1,4869 | 1,8589 | 250 |
| 18 mm | 1,6127 | 2,0159 | 250 |
| 20 mm | 1,7963 | 2,2456 | 250 |
| 22 mm | 2,0057 | 2,5071 | 250 |
| 24 mm | 2,2973 | 2,8718 | 250 |
| 26 mm | 2,5576 | 3,1971 | 250 |

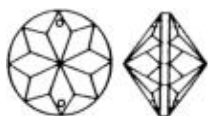

C.0339 Ia

| | | | |
|-------|--------|---------|-----|
| 18 mm | 3,4299 | 4,2874 | 100 |
| 20 mm | 3,8098 | 4,7623 | 100 |
| 22 mm | 3,8408 | 4,8010 | 100 |
| 24 mm | 4,1673 | 5,2090 | 100 |
| 26 mm | 5,0208 | 6,2762 | 100 |
| 28 mm | 6,6474 | 8,3094 | 50 |
| 30 mm | 7,7108 | 9,6385 | 50 |
| 32 mm | 8,4379 | 10,5474 | 50 |

| CRYSTAL | CRYSTAL coated | COLOR | COLOR coated | minimum quantity |
|---------------|--|--|--|---------------------|
| CLEAR | AB AFLAME AMBER ANTIQUÉ GOLD SILVER | ALEXANDRITE AMETHYST AQUAMARINE EMERALD JET ROSALIN RUBY SAPPHIRE SMOKE TOPAZ | AB AFLAME AMBER ANTIQUÉ GOLD SILVER | |
| EURO piece | BB BW OG OS VL VM EURO piece | EURO piece | BB BW OG OS VL VM EURO piece | pieces |



C.0369 la

60 mm

| 21,5944 |

| 26,9932 |

| 25

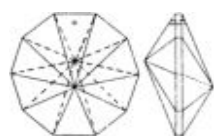

C.0372 la

60 mm

| 21,5944 |

| 26,9932 |

| 25

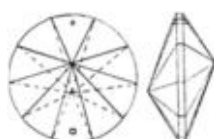

C.0373 la

50 mm

| 16,6523 |

| 20,8153 |

| 25



C.0374 la

40 mm

| 11,9858 |

| 14,9822 |

| 25

50 mm

| 16,6523 |

| 20,8153 |

| 25

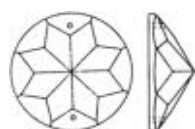

C.0458 la

42 mm

| 7,1441 |

| 8,9302 |

| 50



C.0471 la

42 mm

| 7,1441 |

| 8,9302 |

| 50

| CRYSTAL | CRYSTAL coated | COLOR | COLOR coated | minimum quantity |
|---------------|--|--|--|---------------------|
| CLEAR | AB AFLAME AMBER ANTIQUÉ GOLD SILVER | ALEXANDRITE AMETHYST AQUAMARINE EMERALD JET ROSALIN RUBY SAPPHIRE SMOKE TOPAZ | AB AFLAME AMBER ANTIQUÉ GOLD SILVER | |
| EURO piece | EURO piece | EURO piece | EURO piece | pieces |

OVALS

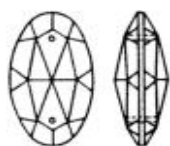

C.0203 lb

| | | | |
|-------|--------|--------|-----|
| 12 mm | 0,5554 | 0,6940 | 500 |
| 14 mm | 0,5554 | 0,6940 | 500 |
| 16 mm | 0,7666 | 0,9584 | 250 |
| 18 mm | 1,0159 | 1,2699 | 250 |
| 20 mm | 1,1029 | 1,3785 | 250 |
| 22 mm | 1,1709 | 1,4636 | 250 |
| 24 mm | 1,3559 | 1,6948 | 250 |
| 26 mm | 1,5202 | 1,9002 | 250 |
| 28 mm | 1,7751 | 2,2190 | 250 |
| 30 mm | 2,1323 | 2,6652 | 250 |
| 32 mm | 2,4191 | 3,0238 | 250 |
| 34 mm | 4,3793 | 5,4740 | 100 |

C.0203 la

| | | | |
|-------|--------|---------|----|
| 36 mm | 7,8975 | 9,8720 | 50 |
| 40 mm | 8,1544 | 10,1931 | 50 |

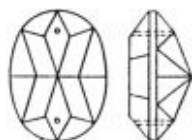

C.0226 lb

| | | | |
|-------|--------|--------|-----|
| 12 mm | 1,0159 | 1,2699 | 250 |
| 14 mm | 1,0159 | 1,2699 | 250 |
| 16 mm | 1,0462 | 1,3077 | 250 |
| 18 mm | 1,1087 | 1,3857 | 250 |
| 20 mm | 1,2012 | 1,5013 | 250 |
| 22 mm | 1,3388 | 1,6736 | 250 |
| 24 mm | 1,5428 | 1,9285 | 250 |
| 26 mm | 1,7448 | 2,1810 | 250 |
| 28 mm | 2,0490 | 2,5612 | 250 |
| 30 mm | 2,4382 | 3,0475 | 250 |
| 32 mm | 2,7250 | 3,4061 | 250 |

C.0226 la

| | | | |
|-------|--------|---------|-----|
| 36 mm | 4,9332 | 6,1664 | 100 |
| 38 mm | 6,2652 | 7,8315 | 100 |
| 42 mm | 7,5972 | 9,4966 | 50 |
| 45 mm | 8,1544 | 10,1931 | 50 |

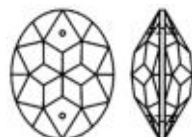

C.0322 lb

| | | | |
|-------|--------|--------|-----|
| 20 mm | 1,1029 | 1,3785 | 250 |
| 22 mm | 1,1709 | 1,4636 | 250 |
| 24 mm | 1,3559 | 1,6948 | 250 |

| CRYSTAL | CRYSTAL <u>coated</u> | C O L O R | C O L O R <u>coated</u> | minimum quantity |
|---------------|--|--|--|---------------------|
| CLEAR | AB AFLAME AMBER ANTIQUÉ GOLD SILVER | ALEXANDRITE AMETHYST AQUAMARINE EMERALD JET ROSALIN RUBY SAPPHIRE SMOKE TOPAZ | AB AFLAME AMBER ANTIQUÉ GOLD SILVER | |
| EURO piece | BB BW OG OS VL VM EURO piece | EURO piece | BB BW OG OS VL VM EURO piece | pieces |

SQUARE STONES

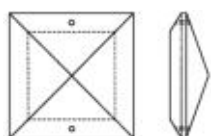

C.0286 lb

| | | | |
|-------|--------|--------|-----|
| 18 mm | 1,5144 | 1,8930 | 250 |
| 20 mm | 2,0490 | 2,5612 | 250 |
| 25 mm | 2,8609 | 3,5761 | 250 |

C.0286 la

| | | | |
|-------|---------|---------|-----|
| 20 mm | 3,5859 | 4,4822 | 100 |
| 25 mm | 5,0083 | 6,2604 | 100 |
| 40 mm | 7,8203 | 9,7753 | 50 |
| 55 mm | 20,3426 | 25,4283 | 25 |
| 65 mm | 52,8907 | 66,1134 | 25 |

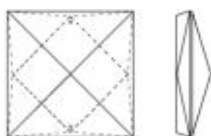

C.0325 la

| | | | |
|-------|---------|---------|----|
| 50 mm | 16,0575 | 20,0719 | 25 |
| 60 mm | 24,0864 | 30,1079 | 25 |
| 70 mm | 36,1294 | 45,1619 | 25 |
| 95 mm | 54,1943 | 67,7428 | 25 |

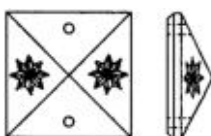

C.0424 la

| | | | |
|-------|--------|--|-----|
| 22 mm | 1,4961 | | 250 |
| 26 mm | 1,6623 | | 250 |

| CRYSTAL | CRYSTAL <u>coated</u> | C O L O R | C O L O R <u>coated</u> | minimum quantity |
|---------------|--|--|--|---------------------|
| CLEAR | AB AFLAME AMBER ANTIQUÉ GOLD SILVER | ALEXANDRITE AMETHYST AQUAMARINE EMERALD JET ROSALIN RUBY SAPPHIRE SMOKE TOPAZ | AB AFLAME AMBER ANTIQUÉ GOLD SILVER | |
| | BB BW OG OS VL VM | | BB BW OG OS VL VM | |
| EURO piece | EURO piece | EURO piece | EURO piece | pieces |

DISTRIBUTORS

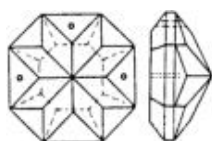

C.0243 lb

| | | | |
|-------|--------|--------|-----|
| 20 mm | 1,5298 | 1,9121 | 250 |
| 26 mm | 2,2402 | 2,8003 | 250 |
| 32 mm | 3,4368 | 4,2961 | 100 |

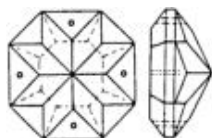

C.0244 lb

| | | | |
|-------|--------|--------|-----|
| 18 mm | 1,6706 | 2,0883 | 250 |
| 24 mm | 2,0679 | 2,5849 | 250 |
| 30 mm | 2,9742 | 3,7176 | 100 |
| 32 mm | 3,4368 | 4,2961 | 100 |

C.0244 la

| | | | |
|-------|---------|---------|----|
| 34 mm | 6,4927 | 8,1158 | 50 |
| 36 mm | 7,0455 | 8,8069 | 50 |
| 38 mm | 7,5708 | 9,4636 | 50 |
| 40 mm | 8,1525 | 10,1906 | 50 |
| 45 mm | 9,6858 | 12,1074 | 50 |
| 50 mm | 14,5167 | 18,1458 | 25 |
| 55 mm | 18,8466 | 23,5584 | 25 |
| 60 mm | 20,7693 | 25,9617 | 25 |
| 65 mm | 25,1108 | 31,3886 | 25 |
| 70 mm | 37,0007 | 46,2507 | 25 |

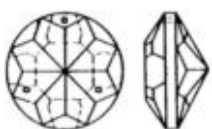

C.0283 lb

| | | | |
|-------|--------|--------|-----|
| 20 mm | 1,6411 | 2,0514 | 250 |
| 24 mm | 1,8450 | 2,3064 | 250 |

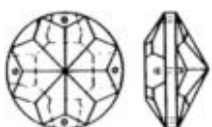

C.0284 lb

| | | | |
|-------|--------|--------|-----|
| 22 mm | 1,6958 | 2,1198 | 250 |
| 24 mm | 1,8450 | 2,3064 | 250 |

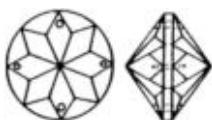

C.0340 lb

| | | | |
|-------|--------|--------|-----|
| 14 mm | 1,1541 | 1,4426 | 250 |
|-------|--------|--------|-----|

C.0340 la

| | | | |
|-------|--------|--------|-----|
| 22 mm | 4,1900 | 5,2375 | 100 |
|-------|--------|--------|-----|

| CRYSTAL | CRYSTAL coated | COLOR | COLOR coated | minimum quantity |
|---------------|--|--|--|---------------------|
| CLEAR | AB AFLAME AMBER ANTIQUÉ GOLD SILVER | ALEXANDRITE AMETHYST AQUAMARINE EMERALD JET ROBALIN RUBY SAPPHIRE SMOKE TOPAZ | AB AFLAME AMBER ANTIQUÉ GOLD SILVER | |
| EURO piece | BB BW OG OS VL VM EURO piece | EURO piece | BB BW OG OS VL VM EURO piece | pieces |

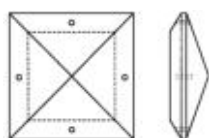

C.0344 lb

20 mm

2,3456

2,9319

250

C.0344 la

35 mm

6,4144

8,0179

50

40 mm

7,8203

9,7753

50

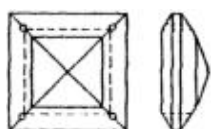

C.0411 lb

22 mm

3,4331

4,2915

100

C.0411 la

25 mm

4,6586

5,8233

100

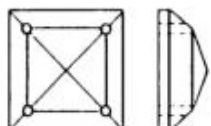

C.0450 lb

20 mm

1,6863

2,1078

250



C.0487 la

60 mm

24,0864

30,1079

25

70 mm

36,1294

45,1619

25

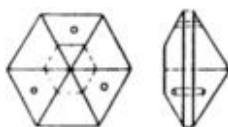

C.0489 lb

22 mm

1,7884

2,2354

250

C.0489 la

35 mm

2,6824

3,3532

100

| CRYSTAL | CRYSTAL coated | COLOR | COLOR coated | minimum quantity |
|---------------|--|--|--|---------------------|
| CLEAR | AB AFLAME AMBER ANTIQUÉ GOLD SILVER | ALEXANDRITE AMETHYST AQUAMARINE EMERALD JET ROBALIN RUBY SAPPHIRE SMOKE TOPAZ | AB AFLAME AMBER ANTIQUÉ GOLD SILVER | |
| | BB BW OG OS VL VM | | BB BW OG OS VL VM | |
| EURO piece | EURO piece | EURO piece | EURO piece | pieces |

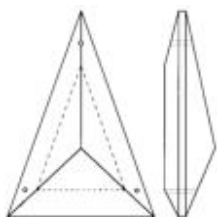

C.0335 la

80x80x50 mm

15,4933

30,9868

25

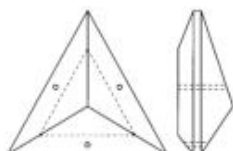

C.0352 la

55x55x55 mm

10,3290

12,9112

25

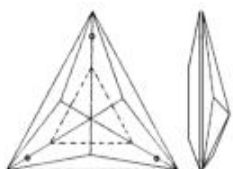

C.0359 la

75x75x75 mm

20,6578

25,8222

25

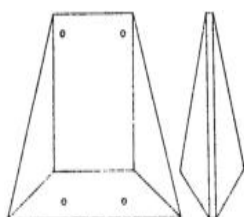

C.0388 la

70x60x35 mm

28,0001

35,0002

25

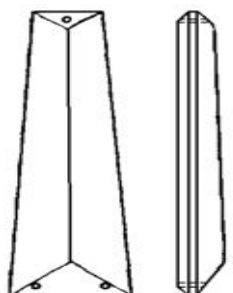

C.0555 la

110x32x18 mm

16,1785

20,2230

25

| CRYSTAL | CRYSTAL coated | C O L O R | C O L O R coated | minimum quantity |
|---------------|--|--|--|---------------------|
| CLEAR | AB AFLAME AMBER ANTIQUÉ GOLD SILVER | ALEXANDRITE AMETHYST AQUAMARINE EMERALD JET RODALIN | AB AFLAME AMBER ANTIQUÉ GOLD SILVER | |
| | BB BW OG OS VL VM | RUBY SAPPHIRE SMOKE TOPAZ | BB BW OG OS VL VM | |
| EURO piece | EURO piece | EURO piece | EURO piece | pieces |



C.0568 lb

50 mm CH: 5,5mm |

4,8477 |

6,0597 |

50

| CRYSTAL | CRYSTAL <u>coated</u> | C O L O R | C O L O R <u>coated</u> | minimum quantity |
|---------------|--|--|--|---------------------|
| CLEAR | AB AFLAME AMBER ANTIQUÉ GOLD SILVER | ALEXANDRITE AMETHYST AQUAMARINE EMERALD JET RODALIN RUBY SAPPHIRE SMOKE TOPAZ | AB AFLAME AMBER ANTIQUÉ GOLD SILVER | |
| EURO piece | BB BW OG OS VL VM EURO piece | EURO piece | BB BW OG OS VL VM EURO piece | pieces |

SOLID BALLS



C.0206 Ib

| | | | |
|-------|--|---------|----|
| 30 mm | | 10,6625 | 50 |
| 40 mm | | 12,9271 | 20 |
| 50 mm | | 19,7739 | 10 |

C.0206 Ia

| | | | |
|--------|----------|--|----|
| 30 mm | 13,9543 | | 50 |
| 40 mm | 16,2761 | | 20 |
| 50 mm | 24,7538 | | 10 |
| 60 mm | 31,8432 | | 5 |
| 70 mm | 44,5548 | | 1 |
| 80 mm | 83,8675 | | 1 |
| 90 mm | 117,7499 | | 1 |
| 100 mm | 173,2009 | | 1 |



C.0205 Ia

| | | | |
|--------|----------|--|----|
| 40 mm | 16,2761 | | 20 |
| 50 mm | 24,7538 | | 10 |
| 60 mm | 31,8432 | | 5 |
| 70 mm | 44,5548 | | 1 |
| 80 mm | 83,8675 | | 1 |
| 90 mm | 117,7499 | | 1 |
| 100 mm | 173,2009 | | 1 |

| CRYSTAL | CRYSTAL <u>coated</u> | C O L O R | C O L O R <u>coated</u> | minimum quantity |
|---------------|--|---|--|---------------------|
| CLEAR | AB AFLAME AMBER ANTIQUÉ GOLD SILVER | ALEXANDRITE AMETHYST AQUAMARINE EMERALD JET ROSA LIN RUBY SAPPHIRE SMOKE TOPAZ | AB AFLAME AMBER ANTIQUÉ GOLD SILVER | |
| EURO piece | BB BW OG OS VL VM EURO piece | EURO piece | BB BW OG OS VL VM EURO piece | pieces |

HOLLOW BALLS



C.0801 la

| | | | | |
|--------|----------|--|--|---|
| 50 mm | 30,9301 | | | 1 |
| 60 mm | 35,8408 | | | 1 |
| 70 mm | 38,9129 | | | 1 |
| 80 mm | 42,4039 | | | 1 |
| 90 mm | 46,7560 | | | 1 |
| 100 mm | 113,6809 | | | 1 |
| 120 mm | 141,7878 | | | 1 |
| 150 mm | 161,4806 | | | 1 |



C.0802 la

| | | | | |
|--------|----------|--|--|---|
| 50 mm | 30,9301 | | | 1 |
| 60 mm | 35,8408 | | | 1 |
| 70 mm | 38,9129 | | | 1 |
| 80 mm | 42,4039 | | | 1 |
| 90 mm | 46,7560 | | | 1 |
| 100 mm | 113,6809 | | | 1 |
| 120 mm | 141,7878 | | | 1 |
| 150 mm | 161,4806 | | | 1 |



C.0803 la

| | | | | |
|--------|----------|--|--|---|
| 50 mm | 40,2162 | | | 1 |
| 60 mm | 53,5285 | | | 1 |
| 70 mm | 59,9752 | | | 1 |
| 80 mm | 68,1673 | | | 1 |
| 90 mm | 77,8025 | | | 1 |
| 100 mm | 132,5501 | | | 1 |
| 120 mm | 141,7878 | | | 1 |
| 150 mm | 161,4806 | | | 1 |



C.0804 la

| | | | | |
|--------|----------|--|--|---|
| 50 mm | 40,2162 | | | 1 |
| 60 mm | 53,5285 | | | 1 |
| 70 mm | 59,9752 | | | 1 |
| 80 mm | 68,1673 | | | 1 |
| 90 mm | 77,8025 | | | 1 |
| 100 mm | 132,5501 | | | 1 |
| 120 mm | 141,7878 | | | 1 |
| 150 mm | 161,4806 | | | 1 |



C.0805 la

| | | | | |
|--------|----------|--|--|---|
| 50 mm | 40,2162 | | | 1 |
| 60 mm | 53,5285 | | | 1 |
| 70 mm | 59,9752 | | | 1 |
| 80 mm | 68,1673 | | | 1 |
| 90 mm | 77,8025 | | | 1 |
| 100 mm | 132,5501 | | | 1 |
| 120 mm | 141,7878 | | | 1 |
| 150 mm | 161,4806 | | | 1 |

| CRYSTAL | CRYSTAL coated | COLOR | COLOR coated | minimum quantity |
|---------------|--|--|--|---------------------|
| CLEAR | AB AFLAME AMBER ANTIQUÉ GOLD SILVER | ALEXANDRITE AMETHYST AQUAMARINE EMERALD JET RODALIN RUBY SAPPHIRE SMOKE TOPAZ | AB AFLAME AMBER ANTIQUÉ GOLD SILVER | |
| EURO piece | BB BW OG OS VL VM EURO piece | EURO piece | BB BW OG OS VL VM EURO piece | pieces |

BELLS



C.0821 la

50 mm

24,9349

1

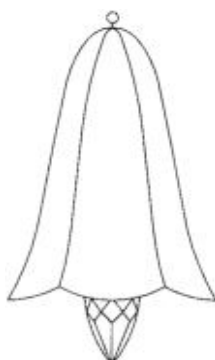

C.0822 la

76 mm

89 mm

36,3717

49,6257

1

1

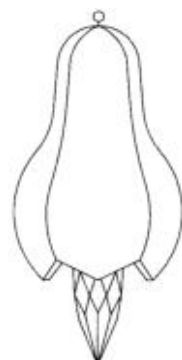

C.0823 la

76 mm

89 mm

36,3717

49,6257

1

1

| CRYSTAL | CRYSTAL coated | C O L O R | C O L O R coated | minimum quantity |
|---------------|--|---|--|---------------------|
| CLEAR | AB AFLAME AMBER ANTIQUÉ GOLD SILVER | ALEXANDRITE AMETHYST AQUAMARINE EMERALD JET ROSA LIN RUBY SAPPHIRE SMOKE TOPAZ | AB AFLAME AMBER ANTIQUÉ GOLD SILVER | |
| | BB BW OG OS VL VM | | BB BW OG OS VL VM | |
| EURO piece | EURO piece | EURO piece | EURO piece | pieces |

FINIALS



C.0334 la

63 mm
76 mm

32,9234
41,1542

41,1542
51,4427

25
25



C.0337 la

30 mm

11,5271

14,4090

25



C.0338 la

40 mm

18,3425

22,9283

25



C.0355 la

55 mm

27,4468

34,3085

25

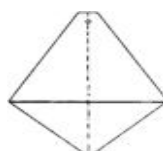

C.0416 la

70 mm

19,8194

26,7562

25

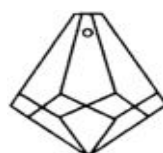

C.0505 la

30 mm

8,1034

10,1292

25

| CRYSTAL | CRYSTAL coated | COLOR | COLOR coated | minimum quantity |
|---------------|--|---|--|---------------------|
| CLEAR | AB AFLAME AMBER ANTIQUÉ GOLD SILVER | ALEXANDRITE AMETHYST AQUAMARINE EMERALD JET ROSA LIN RUBY SAPPHIRE SMOKE TOPAZ | AB AFLAME AMBER ANTIQUÉ GOLD SILVER | |
| EURO piece | BB BW OG OS VL VM EURO piece | EURO piece | BB BW OG OS VL VM EURO piece | pieces |

ICICLES



C.0213 lb

| | | | |
|----------|--------|--------|-----|
| 50x11 mm | 3,3443 | 4,1805 | 100 |
| 63x12 mm | 3,7316 | 4,6644 | 100 |
| 76x13 mm | 4,0840 | 5,1048 | 100 |

C.0213 la

| | | | |
|-----------|---------|---------|----|
| 50x11 mm | 7,6009 | 9,5011 | 50 |
| 63x12 mm | 8,4809 | 10,6013 | 50 |
| 76x13 mm | 9,2818 | 11,6023 | 50 |
| 89x14 mm | 12,1371 | 15,1713 | 50 |
| 100x18 mm | 14,0330 | 17,5412 | 25 |
| 120x20 mm | 22,0479 | | 25 |
| 150x22 mm | 32,3398 | | 25 |

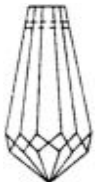

C.0223 la

| | | | |
|----------|---------|---------|----|
| 45x21 mm | 10,4998 | 13,1248 | 50 |
|----------|---------|---------|----|

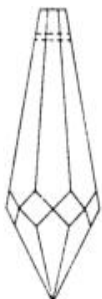

C.0262 lb

| | | | |
|----------|--------|--------|-----|
| 38x17 mm | 2,7949 | 3,4935 | 100 |
|----------|--------|--------|-----|

C.0262 la

| | | | |
|----------|---------|---------|----|
| 38x17 mm | 7,3780 | 9,2226 | 50 |
| 45x18 mm | 7,9209 | 9,9011 | 50 |
| 50x19 mm | 9,2232 | 11,5290 | 50 |
| 63x21 mm | 10,6453 | 13,3068 | 50 |
| 76x23 mm | 12,8830 | 16,1038 | 25 |



C.0357 lb

| | | | |
|----------|--------|--------|-----|
| 38x15 mm | 3,2349 | 4,0437 | 100 |
|----------|--------|--------|-----|

| CRYSTAL | CRYSTAL <u>coated</u> | COLOR | COLOR <u>coated</u> | minimum quantity |
|---------------|--|--|--|---------------------|
| CLEAR | AB AFLAME AMBER ANTIQUÉ GOLD SILVER | ALEXANDRITE AMETHYST AQUAMARINE EMERALD JET ROSALIN RUBY SAPPHIRE SMOKE TOPAZ | AB AFLAME AMBER ANTIQUÉ GOLD SILVER | |
| EURO piece | BB BW OG OS VL VM EURO piece | EURO piece | BB BW OG OS VL VM EURO piece | pieces |



C.0358 la

| | | | |
|-----------|---------|---------|----|
| 76x11 mm | 10,1107 | 12,6385 | 50 |
| 89x12 mm | 11,5894 | 14,4868 | 50 |
| 100x13 mm | 12,5677 | 15,7097 | 50 |



C.0397 lb

| | | | |
|----------|--------|--------|-----|
| 50x9 mm | 3,3443 | 4,1805 | 100 |
| 63x10 mm | 3,7316 | 4,6644 | 100 |
| 76x11 mm | 4,0840 | 5,1048 | 100 |

C.0397 la

| | | | |
|-----------|---------|---------|----|
| 50x9 mm | 5,9958 | 7,4949 | 50 |
| 63x10 mm | 6,6284 | 8,2854 | 50 |
| 76x11 mm | 7,5048 | 9,3810 | 50 |
| 89x12 mm | 9,3872 | 11,7340 | 50 |
| 100x12 mm | 12,6414 | 15,8016 | 25 |
| 115x12 mm | 13,6347 | | 25 |
| 165x22 mm | 35,2725 | | 25 |
| 180x24 mm | 40,5635 | | 25 |

| CRYSTAL | CRYSTAL coated | COLOR | COLOR coated | minimum quantity |
|---------------|--|--|--|---------------------|
| CLEAR | AB AFLAME AMBER ANTIQUÉ GOLD SILVER | ALEXANDRITE AMETHYST AQUAMARINE EMERALD JET RODALIN RUBY SAPPHIRE SMOKE TOPAZ | AB AFLAME AMBER ANTIQUÉ GOLD SILVER | |
| | BB BW OG OS VL VM | | BB BW OG OS VL VM | |
| EURO piece | EURO piece | EURO piece | EURO piece | pieces |

PRISMS

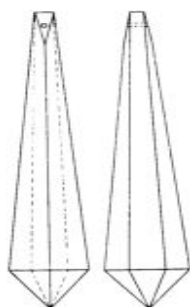

C.0214 la
89x19 mm
115x23 mm

11,7274
18,3313

14,6591

25
25

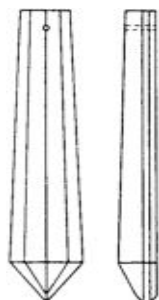

C.0232 la
100x20 mm

14,0936

17,6170

25

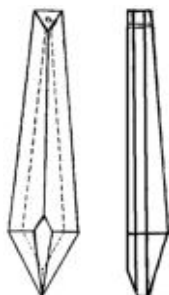

C.0277 lb
100x23 mm

7,4859

9,3575

50

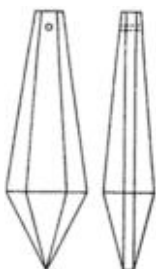

C.0333 la
76x22 mm

11,7502

14,6877

25

| CRYSTAL | CRYSTAL coated | COLOR | COLOR coated | minimum quantity |
|---------------|--|---|--|---------------------|
| CLEAR | AB AFLAME AMBER ANTIQUÉ GOLD SILVER | ALEXANDRITE AMETHYST AQUAMARINE EMERALD JET ROSA LIN RUBY SAPPHIRE SMOKE TOPAZ | AB AFLAME AMBER ANTIQUÉ GOLD SILVER | |
| | BB BW OG OS VL VM | | BB BW OG OS VL VM | |
| EURO piece | EURO piece | EURO piece | EURO piece | pieces |

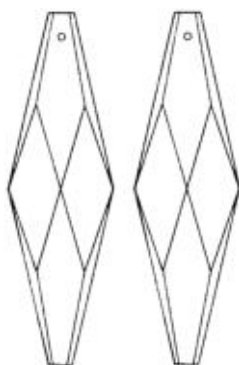

C.0336 la
115x29 mm

28,4250

25

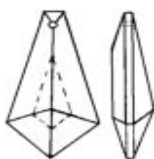

C.0341 lb
38x21 mm

3,1878

3,9847

100

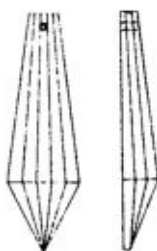

C.0342 lb
63x18 mm
76x20 mm

3,5064
4,2300

4,3830
5,2875

100
100

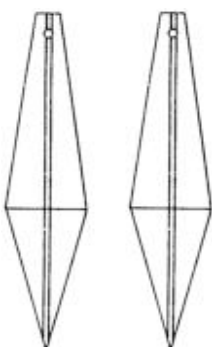

C.0345 la
43x12 mm
76x14 mm
100x16 mm
150x20 mm

7,4575
8,7928
14,3769
30,3455

9,3218
10,9911
17,9710

50
50
25
25

| CRYSTAL | CRYSTAL coated | COLOR | COLOR coated | minimum quantity |
|---------------|--|--|--|---------------------|
| CLEAR | AB AFLAME AMBER ANTIQUÉ GOLD SILVER | ALEXANDRITE AMETHYST AQUAMARINE EMERALD JET RODALIN RUBY SAPPHIRE SMOKE TOPAZ | AB AFLAME AMBER ANTIQUÉ GOLD SILVER | |
| EURO piece | BB BW OG OS VL VM EURO piece | EURO piece | BB BW OG OS VL VM EURO piece | pieces |

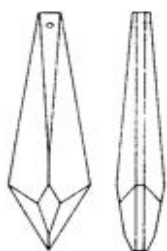

C.0436 la

76x20 mm
100x30 mm

10,8831
15,6136

13,6040
19,5170

25
25

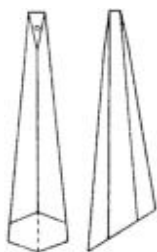

C.0444 la

50x16 mm
63x18 mm
76x20 mm
95x22 mm
125x28 mm
150x32 mm

5,5635
6,4983
7,4764
9,1890
19,3152
33,5541

6,9544
8,1229
9,3455
11,4862

100
50
50
50
25
25

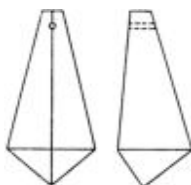

C.0461 la

50x22 mm

7,4575

9,3218

50

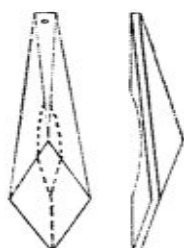

C.0474 la

100x19 mm
125x23 mm

13,6932
17,4190

17,1166

25
25

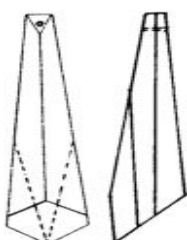

C.0506 la

100x23 mm

16,3862

20,4829

25

| CRYSTAL | CRYSTAL <u>coated</u> | C O L O R | C O L O R <u>coated</u> | minimum quantity |
|---------------|--|--|--|---------------------|
| CLEAR | AB AFLAME AMBER ANTIQUÉ GOLD SILVER | ALEXANDRITE AMETHYST AQUAMARINE EMERALD JET ROSALIN RUBY SAPPHIRE SMOKE TOPAZ | AB AFLAME AMBER ANTIQUÉ GOLD SILVER | |
| | BB BW OG OS VL VM | | BB BW OG OS VL VM | |
| EURO piece | EURO piece | EURO piece | EURO piece | pieces |

POINTED STONES

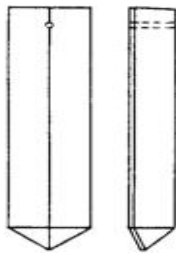

C.0224 la

76x18 mm
89x20 mm
100x20 mm
125x20 mm
150x20 mm

10,5891
12,1018
15,2533
21,4303
32,8157

13,2364
15,1273
19,0668

50
50
25
25
25

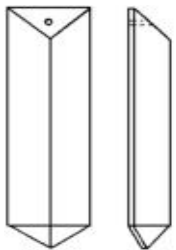

C.0327 la

63x14 mm
76x18 mm
76x24 mm
89x20 mm
89x24 mm
100x20 mm
125x22 mm
150x22 mm

6,9611
10,5891
11,3455
12,1018
12,8583
15,2533
21,4303
32,8157

8,7013
13,2364
14,1818
15,1273
16,0729
19,0668

50
50
50
50
25
25
25
25

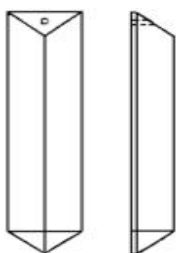

C.0423 lb

89x20 mm

6,1957

7,7445

50

C.0423 la

63x18 mm
89x20 mm

4,8645
7,7445

6,0807
9,6807

100
50

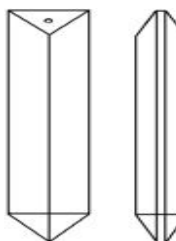

C.0536 la

95x22 mm

15,4758

19,3447

25

| CRYSTAL | CRYSTAL coated | COLOR | COLOR coated | minimum quantity |
|---------------|--|--|--|---------------------|
| CLEAR | AB AFLAME AMBER ANTIQUÉ GOLD SILVER | ALEXANDRITE AMETHYST AQUAMARINE EMERALD JET ROSALIN RUBY SAPPHIRE SMOKE TOPAZ | AB AFLAME AMBER ANTIQUÉ GOLD SILVER | |
| EURO piece | BB BW OG OS VL VM EURO piece | EURO piece | BB BW OG OS VL VM EURO piece | pieces |

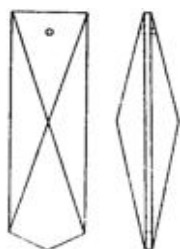

C.0293 la
55x16 mm

| | | |
|--------|---------|----|
| 8,8567 | 11,0710 | 50 |
|--------|---------|----|



C.0349 lb
50x18 mm
63x18 mm
76x18 mm

| | | |
|--------|--------|-----|
| 3,7637 | 4,7045 | 100 |
| 4,1130 | 5,1414 | 100 |
| 4,6966 | 5,8709 | 100 |

C.0349 la
63x18 mm
76x18 mm
89x20 mm
100x22 mm
115x22 mm

| | | |
|---------|---------|----|
| 6,5491 | 8,1864 | 50 |
| 7,6144 | 9,5179 | 50 |
| 9,7330 | 12,1664 | 50 |
| 11,7724 | 14,7156 | 50 |
| 14,3484 | | 25 |

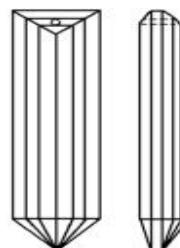

C.0478 lb
76x20 mm

| | | |
|--------|--------|-----|
| 5,4975 | 6,8718 | 100 |
|--------|--------|-----|



C.0480 lb
52x22 mm
65x22 mm

| | | |
|--------|--------|-----|
| 3,7637 | 4,7045 | 100 |
| 4,1130 | 5,1414 | 100 |

| CRYSTAL | CRYSTAL coated | COLOR | COLOR coated | minimum quantity |
|---------------|--|--|--|---------------------|
| CLEAR | AB AFLAME AMBER ANTIQUÉ GOLD SILVER | ALEXANDRITE AMETHYST AQUAMARINE EMERALD JET RODALIN RUBY SAPPHIRE SMOKE TOPAZ | AB AFLAME AMBER ANTIQUÉ GOLD SILVER | |
| EURO piece | BB BW OG OS VL VM EURO piece | EURO piece | BB BW OG OS VL VM EURO piece | pieces |

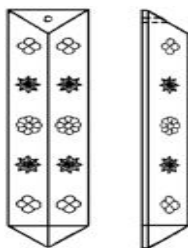

C.0425 la

100x22 mm
150x26 mm

17,5098
26,2648

50
25

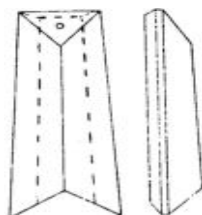

C.0310 la

76x30x22 mm

15,3021

19,1276

25

| CRYSTAL | CRYSTAL coated | COLOR | COLOR coated | minimum quantity |
|---------------|--|--|--|---------------------|
| CLEAR | AB AFLAME AMBER ANTIQUÉ GOLD SILVER | ALEXANDRITE AMETHYST AQUAMARINE EMERALD JET RODALIN RUBY SAPPHIRE SMOKE TOPAZ | AB AFLAME AMBER ANTIQUÉ GOLD SILVER | |
| | BB BW OG OS VL VM | | BB BW OG OS VL VM | |
| EURO piece | EURO piece | EURO piece | EURO piece | pieces |

ALBERTS

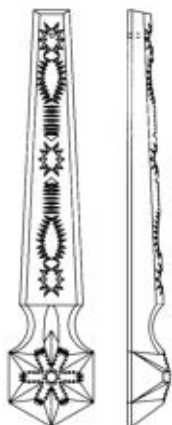

C.0246 la
205x40 mm

| 37,5484 |

| 46,9354 |

| 10

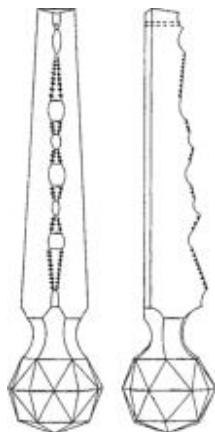

C.0530 la
205x40 mm

| 37,5484 |

| 46,9354 |

| 10

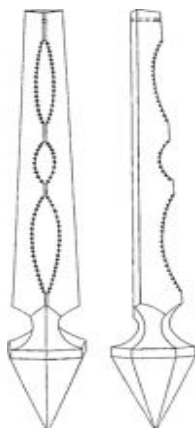

C.0531 la
250x40 mm

| 37,5484 |

| 46,9354 |

| 10

| CRYSTAL | CRYSTAL coated | COLOR | COLOR coated | minimum quantity |
|---------------|--|--|--|---------------------|
| CLEAR | AB AFLAME AMBER ANTIQUÉ GOLD SILVER | ALEXANDRITE AMETHYST AQUAMARINE EMERALD JET RODALIN RUBY SAPPHIRE SMOKE TOPAZ | AB AFLAME AMBER ANTIQUÉ GOLD SILVER | |
| EURO piece | BB BW OG OS VL VM EURO piece | EURO piece | BB BW OG OS VL VM EURO piece | pieces |

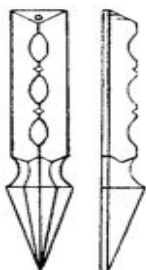

| | | | |
|-------------------------------|---------|---------|----|
| C.0229 lb 100x16 mm | 7,6652 | 9,5817 | 50 |
| C.0229 la 100x16 mm | 11,4894 | 14,3619 | 50 |

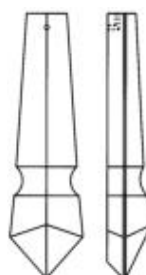

| | | | |
|------------------------------|---------|--|----|
| C.0249 la 63x20 mm | 4,8207 | | 50 |
| 76x21 mm | 5,2530 | | 50 |
| 89x22 mm | 6,1506 | | 50 |
| 100x26 mm | 7,8462 | | 50 |
| 125x28 mm | 12,1017 | | 25 |
| 140x31 mm | 13,5313 | | 25 |
| 150x33 mm | 15,8586 | | 25 |
| 175x34 mm | 20,9453 | | 25 |
| 200x35 mm | 24,9349 | | 25 |

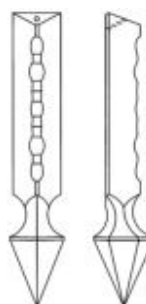

| | | | |
|------------------------------|---------|--|----|
| C.0292 la 76x16 mm | 5,8004 | | 50 |
| 100x16 mm | 6,6794 | | 50 |
| 125x18 mm | 17,0969 | | 25 |
| 150x18 mm | 19,3705 | | 25 |
| 175x20 mm | 23,4881 | | 25 |
| 200x20 mm | 30,6699 | | 25 |

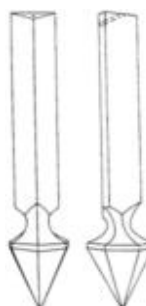

| | | | |
|------------------------------|---------|--|----|
| C.0529 la 76x16 mm | 4,8562 | | 50 |
| 100x16 mm | 5,7916 | | 50 |
| 125x18 mm | 15,3424 | | 32 |
| 150x18 mm | 17,1864 | | 32 |
| 175x20 mm | 20,8564 | | 12 |
| 200x20 mm | 23,2621 | | 12 |
| 250x22 mm | 26,1127 | | 10 |
| 300x24 mm | 31,4202 | | 10 |

| CRYSTAL | CRYSTAL <u>coated</u> | C O L O R | C O L O R <u>coated</u> | minimum quantity |
|---------------|--|--|--|---------------------|
| CLEAR | AB AFLAME AMBER ANTIQUÉ GOLD SILVER | ALEXANDRITE AMETHYST AQUAMARINE EMERALD JET ROBALIN RUBY SAPPHIRE SMOKE TOPAZ | AB AFLAME AMBER ANTIQUÉ GOLD SILVER | |
| | BB BW OG OS VL VM | | BB BW OG OS VL VM | |
| EURO piece | EURO piece | EURO piece | EURO piece | pieces |

RECTANGLE STONES

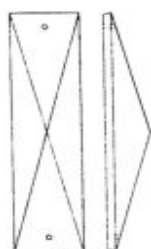

C.0233 la

75x17 mm
85x19 mm
100x24 mm

6,7832
8,0467
12,2371

8,4790
10,0586
15,2965

50
50
25

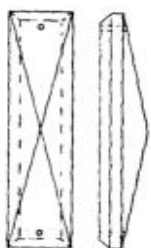

C.0260 la

70x17 mm
70x35 mm
80x18 mm
80x25 mm
100x40 mm
120x40 mm

7,1516
12,7470
8,7662
11,9219
26,7026
32,9385

8,9393
15,9338
10,9579
14,9023
33,3783

50
25
50
50
25
25



C.0261 la

74x20 mm

12,5169

15,6462

25



C.0288 lb

76x17 mm

5,4103

6,7629

100

C.0288 la

120x20 mm

22,9048

25

| CRYSTAL | CRYSTAL coated | C O L O R | C O L O R coated | minimum quantity |
|---------------|--|--|--|---------------------|
| CLEAR | AB AFLAME AMBER ANTIQUÉ GOLD SILVER | ALEXANDRITE AMETHYST AQUAMARINE EMERALD JET RODALIN RUBY SAPPHIRE SMOKE TOPAZ | AB AFLAME AMBER ANTIQUÉ GOLD SILVER | |
| EURO piece | BB BW OG OS VL VM EURO piece | EURO piece | BB BW OG OS VL VM EURO piece | pieces |

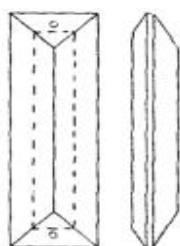

C.0316 lb

58x18 mm

4,2074

5,2592

100

C.0316 la

58x18 mm

6,7645

8,4556

50

65x20 mm

7,8786

9,8484

50

80x25 mm

9,9314

12,4142

50

100x37 mm

26,1761

32,7200

25

115x54 mm

30,1023

25

132x20 mm

34,5523

25



C.0351 lb

60x30 mm

5,0007

6,2507

100

C.0351 la

94x21 mm

10,4585

13,0731

50

123x26 mm

18,9184

25

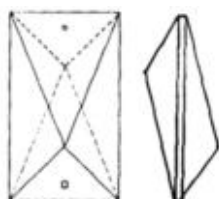

C.0353 la

75x40 mm

27,6093

34,5115

25

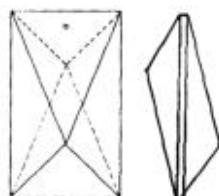

C.0356 la

75x40 mm

27,6093

34,5115

25

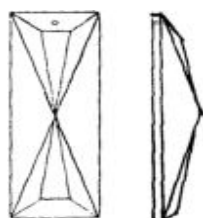

C.0370 lb

65x25 mm

5,0007

6,2507

100

| CRYSTAL | CRYSTAL coated | COLOR | COLOR coated | minimum quantity |
|---------------|--|--|--|---------------------|
| CLEAR | AB AFLAME AMBER ANTIQUÉ GOLD SILVER | ALEXANDRITE AMETHYST AQUAMARINE EMERALD JET RODALIN RUBY SAPPHIRE SMOKE TOPAZ | AB AFLAME AMBER ANTIQUÉ GOLD SILVER | |
| EURO piece | BB BW OG OS VL VM EURO piece | EURO piece | BB BW OG OS VL VM EURO piece | pieces |

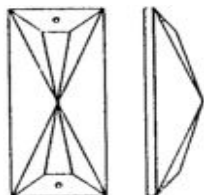

C.0400 la
58x25 mm

7,2346

9,0433

50

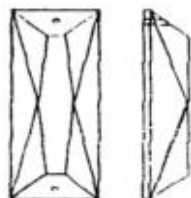

C.0409 lb
60x20 mm

4,4133

5,5168

100

C.0409 la
60x20 mm

7,6105

9,5132

50

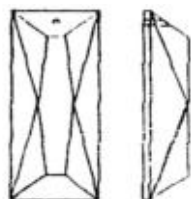

C.0420 lb
76x27 mm

5,5903

6,9878

100

C.0420 la
76x27 mm

12,6840

15,8549

25

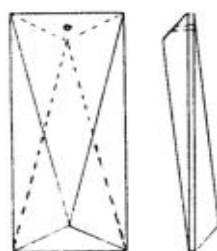

C.0419 la
80x30 mm
98x37 mm

14,1029
21,8381

17,6286
27,2976

25
25

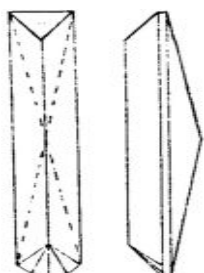

C.0433 la
55x16 mm
105x16 mm

10,7302
14,9038

13,4126
18,6297

25
25

| CRYSTAL | CRYSTAL coated | COLOR | COLOR coated | minimum quantity |
|---------------|--|--|--|---------------------|
| CLEAR | AB AFLAME AMBER ANTIQUÉ GOLD SILVER | ALEXANDRITE AMETHYST AQUAMARINE EMERALD JET ROSALIN RUBY SAPPHIRE SMOKE TOPAZ | AB AFLAME AMBER ANTIQUÉ GOLD SILVER | |
| EURO piece | BB BW OG OS VL VM EURO piece | EURO piece | BB BW OG OS VL VM EURO piece | pieces |

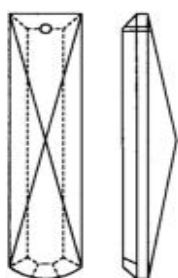

C.0485 lb

76x16 mm

5,4103

6,7629

100

C.0485 la

76x16 mm

9,2780

11,5975

50

89x20 mm

11,8330

14,7913

50

105x16 mm

14,3862

17,9828

25

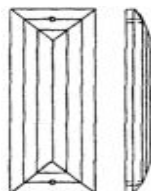

C.0537 lb

76x28 mm

5,9335

7,4170

50



C.0541 la

50x20 mm

9,6670

12,0838

50

76x20 mm

12,7979

15,9975

25

100x20 mm

14,8961

18,6200

25

125x20 mm

19,8306

25

150x20 mm

27,2013

25

175x20 mm

37,2101

25

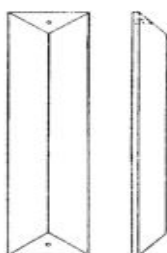

C.0551 lb

22x22 mm

4,1321

5,1650

100

76x22 mm

7,7693

9,7116

50

102x22 mm

10,7455

13,4319

50

102x26 mm

12,3560

15,4451

50

C.0551 la

63x22 mm

6,9308

8,6633

50

76x22 mm

8,5035

10,6295

50

102x22 mm

12,3164

15,3957

50

102x26 mm

14,3769

17,9710

25

110x16 mm

17,1226

25

127x26 mm

21,8889

25

152x26 mm

34,9892

25

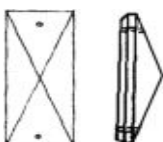

C.0556 lb

40x15 mm

2,8458

3,5572

100

C.0556 la

40x15 mm

3,4748

4,3436

100

| CRYSTAL | CRYSTAL coated | COLOR | COLOR coated | minimum quantity |
|---------------|--|--|--|---------------------|
| CLEAR | AB AFLAME AMBER ANTIQUÉ GOLD SILVER | ALEXANDRITE AMETHYST AQUAMARINE EMERALD JET RODALIN RUBY SAPPHIRE SMOKE TOPAZ | AB AFLAME AMBER ANTIQUÉ GOLD SILVER | |
| | BB BW OG OS VL VM | | BB BW OG OS VL VM | |
| EURO piece | EURO piece | EURO piece | EURO piece | pieces |

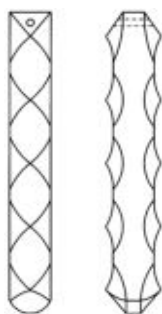

C.0502 lb
89x16 mm

| 12,7979 |

| 15,9975 |

| 25

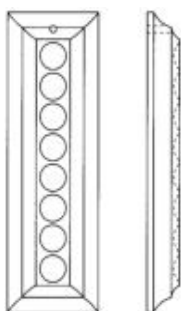

C.0512 lb
89x28 mm

| 11,5044 |

| 14,3804 |

| 25

| CRYSTAL | CRYSTAL coated | COLOR | COLOR coated | minimum quantity |
|---------------|--|--|--|---------------------|
| CLEAR | AB AFLAME AMBER ANTIQUÉ GOLD SILVER | ALEXANDRITE AMETHYST AQUAMARINE EMERALD JET ROSALIN RUBY SAPPHIRE SMOKE TOPAZ | AB AFLAME AMBER ANTIQUÉ GOLD SILVER | |
| EURO piece | BB BW OG OS VL VM EURO piece | EURO piece | BB BW OG OS VL VM EURO piece | pieces |

COFFIN STONES

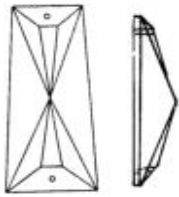

C.0234 lb

| | | | |
|-------------|--------|--------|-----|
| 45x16x10 mm | 2,7910 | 3,4887 | 100 |
| 52x18x14 mm | 3,0716 | 3,8393 | 100 |
| 62x24x20 mm | 4,5439 | 5,6797 | 100 |
| 65x28x22 mm | 5,5766 | 6,9706 | 100 |

C.0234 la

| | | | |
|-------------|---------|---------|-----|
| 45x16x10 mm | 4,3340 | 5,4176 | 100 |
| 52x18x14 mm | 5,3441 | 6,6803 | 100 |
| 62x24x20 mm | 6,9308 | 8,6633 | 50 |
| 65x28x22 mm | 7,5086 | 9,3857 | 50 |
| 76x36x30 mm | 10,5073 | 13,1341 | 50 |

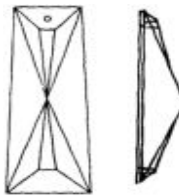

C.0410 lb

| | | | |
|-------------|--------|--------|-----|
| 62x24x20 mm | 4,5439 | 5,6797 | 100 |
| 65x28x22 mm | 5,5766 | 6,9706 | 100 |

C.0410 la

| | | | |
|-------------|---------|---------|----|
| 62x24x20 mm | 6,9308 | 8,6633 | 50 |
| 65x28x22 mm | 7,5086 | 9,3857 | 50 |
| 76x36x30 mm | 10,5073 | 13,1339 | 50 |

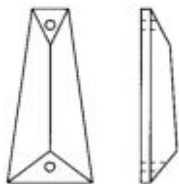

C.0453 lb

| | | | |
|------------|--------|--------|-----|
| 38x18x8 mm | 2,7910 | 3,4887 | 100 |
|------------|--------|--------|-----|

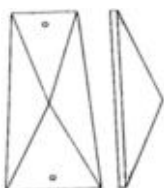

C.0454 lb

| | | | |
|-------------|--------|--------|-----|
| 52x18x14 mm | 3,3424 | 4,1782 | 100 |
|-------------|--------|--------|-----|

C.0454 la

| | | | |
|-------------|---------|---------|-----|
| 52x18x14 mm | 4,3963 | 5,4954 | 100 |
| 58x26x18 mm | 6,0828 | 7,6034 | 100 |
| 63x30x22 mm | 7,2705 | 9,0881 | 50 |
| 76x36x30 mm | 12,9303 | 16,1629 | 25 |

| CRYSTAL | CRYSTAL <u>coated</u> | C O L O R | C O L O R <u>coated</u> | minimum quantity |
|---------------|--|--|--|---------------------|
| CLEAR | AB AFLAME AMBER ANTIQUÉ GOLD SILVER | ALEXANDRITE AMETHYST AQUAMARINE EMERALD JET RODALIN RUBY SAPPHIRE SMOKE TOPAZ | AB AFLAME AMBER ANTIQUÉ GOLD SILVER | |
| EURO piece | BB BW OG OS VL VM EURO piece | EURO piece | BB BW OG OS VL VM EURO piece | pieces |

SPECIAL STONES

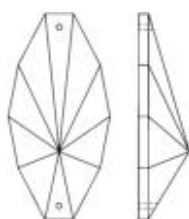

C.0414 lb
76x36 mm

11,5838

14,4798

25

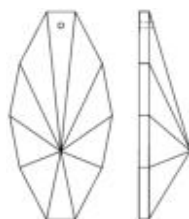

C.0415 lb
76x36 mm

11,5838

14,4798

25

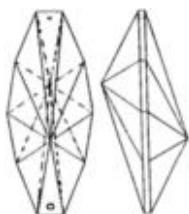

C.0417 la
75x35 mm
90x35 mm
125x40 mm

17,3758
24,3385
50,8919

21,7196
30,4234

25
25
25

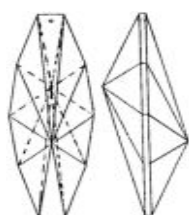

C.0418 la
75x35 mm
90x35 mm
125x40 mm

17,3758
24,3385
50,8919

21,7196
30,4234

25
25
25

| CRYSTAL | CRYSTAL coated | COLOR | COLOR coated | minimum quantity |
|---------------|--|--|--|---------------------|
| CLEAR | AB AFLAME AMBER ANTIQUÉ GOLD SILVER | ALEXANDRITE AMETHYST AQUAMARINE EMERALD JET ROSALIN RUBY SAPPHIRE SMOKE TOPAZ | AB AFLAME AMBER ANTIQUÉ GOLD SILVER | |
| | BB BW OG OS VL VM | | BB BW OG OS VL VM | |
| EURO piece | EURO piece | EURO piece | EURO piece | pieces |

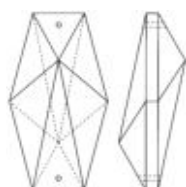

C.0307 la
75x40 mm

22,7901

28,4876

25

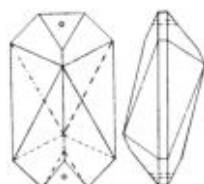

C.0308 la
70x40 mm

22,7901

28,4876

25

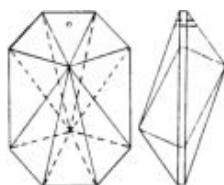

C.0395 la
70x50 mm

28,4117

35,5147

25

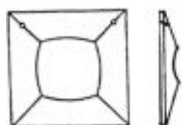

C.0378 la
40x40 mm
50x50 mm

7,9353
9,9521

9,9191
12,4403

50
50

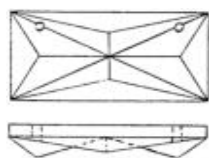

C.0386 lb
100x50 mm

17,9706

22,4632

25

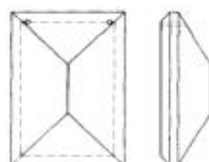

C.0486 la
63x46 mm

21,6679

27,0849

25

| CRYSTAL | CRYSTAL coated | COLOR | COLOR coated | minimum quantity |
|---------------|--|--|--|---------------------|
| CLEAR | AB AFLAME AMBER ANTIQUÉ GOLD SILVER | ALEXANDRITE AMETHYST AQUAMARINE EMERALD JET ROSALIN RUBY SAPPHIRE SMOKE TOPAZ | AB AFLAME AMBER ANTIQUÉ GOLD SILVER | |
| | BB BW OG OS VL VM | | BB BW OG OS VL VM | |
| EURO piece | EURO piece | EURO piece | EURO piece | pieces |

DECORATION STONES

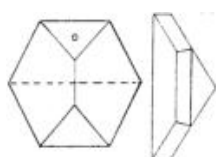

C.0248 la
45x50 mm

| 14,4790 |

| 18,0986 |

| 25

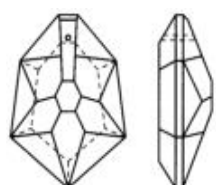

C.0250 la
34x24 mm

| 5,3273 |

| 6,6593 |

| 100

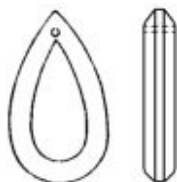

C.0251 lb
30x16 mm

| 2,1001 |

| 2,6250 |

| 250

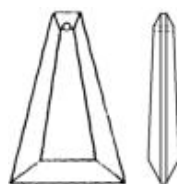

C.0254 la
30x20x5 mm

| 5,2800 |

| 6,5999 |

| 100

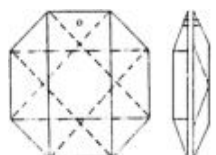

C.0428 la
42 mm

| 11,1417 |

| 13,9271 |

| 50

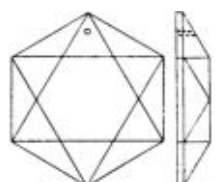

C.0430 la
48x42 mm

| 9,0078 |

| 11,2598 |

| 50

| CRYSTAL | CRYSTAL coated | COLOR | COLOR coated | minimum quantity |
|---------------|--|--|--|---------------------|
| CLEAR | AB AFLAME AMBER ANTIQUÉ GOLD SILVER | ALEXANDRITE AMETHYST AQUAMARINE EMERALD JET RODALIN RUBY SAPPHIRE SMOKE TOPAZ | AB AFLAME AMBER ANTIQUÉ GOLD SILVER | |
| | BB BW OG OS VL VM | | BB BW OG OS VL VM | |
| EURO piece | EURO piece | EURO piece | EURO piece | pieces |

HEART STONES

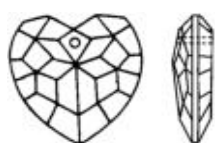

C.0252 lb

20 mm

| 1,8884 |

| 2,3603 |

| 250

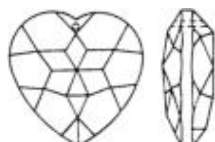

C.0432 lb

30 mm

| 4,2734 |

| 5,3418 |

| 100



C.0447 lb

40 mm

| 6,5624 |

| 8,2030 |

| 50

C.0447 la

40 mm

| 11,3893 |

| 14,2366 |

| 50

| CRYSTAL | CRYSTAL coated | COLOR | COLOR coated | minimum quantity |
|---------------|--|--|--|---------------------|
| CLEAR | AB AFLAME AMBER ANTIQUÉ GOLD SILVER | ALEXANDRITE AMETHYST AQUAMARINE EMERALD JET ROSALIN RUBY SAPPHIRE SMOKE TOPAZ | AB AFLAME AMBER ANTIQUÉ GOLD SILVER | |
| | BB BW OG OS VL VM | | BB BW OG OS VL VM | |
| EURO piece | EURO piece | EURO piece | EURO piece | pieces |

ALMONDS

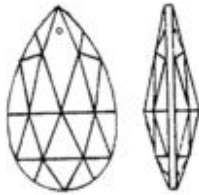

C.0207 lb

| | | | |
|----------|--------|--------|-----|
| 32x20 mm | 2,6268 | 3,2837 | 250 |
| 38x23 mm | 2,7553 | 3,4441 | 250 |
| 45x25 mm | 3,0083 | 3,7604 | 250 |
| 50x31 mm | 3,1745 | 3,9681 | 250 |
| 63x38 mm | 5,7333 | 7,1665 | 100 |

C.0207 la

| | | | |
|-----------|---------|---------|----|
| 30x20 mm | 7,8807 | 9,8508 | 50 |
| 38x23 mm | 8,2657 | 10,3321 | 50 |
| 45x25 mm | 8,9250 | 11,1563 | 50 |
| 50x31 mm | 9,5895 | 11,9870 | 50 |
| 57x30 mm | 11,3119 | 14,1398 | 50 |
| 63x32 mm | 13,3834 | 16,7291 | 25 |
| 76x38 mm | 20,4899 | 25,6124 | 25 |
| 89x43 mm | 25,5034 | 31,8792 | 25 |
| 100x47 mm | 31,3313 | 39,1641 | 25 |

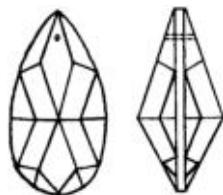

C.0208 lb

| | | | |
|----------|--------|--------|-----|
| 38x21 mm | 5,2659 | 6,5825 | 100 |
| 50x28 mm | 6,3681 | 7,9602 | 50 |

C.0208 la

| | | | |
|----------|---------|---------|----|
| 32x17 mm | 5,3616 | 6,7019 | 50 |
| 38x21 mm | 6,6381 | 8,2976 | 50 |
| 50x28 mm | 8,6697 | 10,8373 | 50 |
| 63x34 mm | 11,8386 | 14,7982 | 50 |
| 76x38 mm | 21,3473 | 26,6839 | 25 |
| 89x52 mm | 28,3119 | 35,3898 | 25 |

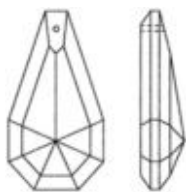

C.0219 lb

| | | | |
|----------|--------|--------|-----|
| 38x22 mm | 4,9120 | 6,1403 | 100 |
| 50x24 mm | 5,8734 | 7,3419 | 100 |
| 63x31 mm | 7,4876 | 9,3594 | 50 |

C.0219 la

| | | | |
|-----------|---------|---------|----|
| 38x22 mm | 7,0175 | 8,7718 | 50 |
| 45x23 mm | 7,7038 | 9,6298 | 50 |
| 50x24 mm | 8,3904 | 10,4880 | 50 |
| 63x31 mm | 10,6964 | 13,3703 | 50 |
| 76x39 mm | 16,8223 | 21,0279 | 25 |
| 89x44 mm | 20,3897 | 25,4870 | 25 |
| 115x56 mm | 25,2006 | 31,5009 | 25 |

| CRYSTAL | CRYSTAL <u>coated</u> | C O L O R | C O L O R <u>coated</u> | minimum quantity |
|---------------|--|---|--|---------------------|
| CLEAR | AB AFLAME AMBER ANTIQUÉ GOLD SILVER | ALEXANDRITE AMETHYST AQUAMARINE EMERALD JET ROSA LIN RUBY SAPPHIRE SMOKE TOPAZ | AB AFLAME AMBER ANTIQUÉ GOLD SILVER | |
| EURO piece | EURO piece | EURO piece | EURO piece | pieces |

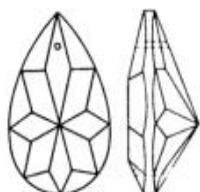

C.0222 lb

| | | | |
|----------|--------|--------|-----|
| 22x12 mm | 1,7149 | 2,1435 | 250 |
| 25x20 mm | 1,8054 | 2,2568 | 250 |
| 30x22 mm | 2,7645 | 3,4557 | 250 |
| 35x25 mm | 3,0389 | 3,7981 | 100 |
| 40x28 mm | 3,4916 | 4,3645 | 100 |

C.0222 la

| | | | |
|----------|---------|---------|-----|
| 25x20 mm | 3,9092 | 4,8865 | 100 |
| 28x20 mm | 4,2284 | 5,2856 | 100 |
| 30x22 mm | 4,5136 | 5,6419 | 100 |
| 32x23 mm | 4,8797 | 6,0996 | 100 |
| 35x25 mm | 5,5311 | 6,9140 | 100 |
| 40x28 mm | 7,0306 | 8,7882 | 50 |
| 45x32 mm | 7,6746 | 9,5933 | 50 |
| 50x34 mm | 8,8964 | 11,1206 | 50 |
| 65x45 mm | 12,8263 | 16,0330 | 25 |
| 70x47 mm | 15,5551 | 19,4439 | 25 |

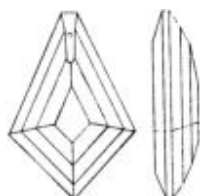

C.0235 la

| | | | |
|----------|---------|---------|----|
| 70x45 mm | 13,4799 | 16,8499 | 25 |
|----------|---------|---------|----|

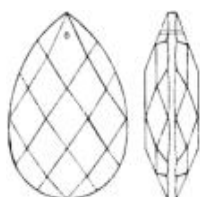

C.0238 lb

| | | | |
|----------|--------|--------|-----|
| 38x25 mm | 2,1528 | 2,6912 | 250 |
| 50x34 mm | 3,3746 | 4,2182 | 250 |

C.0238 la

| | | | |
|-----------|---------|---------|----|
| 38x25 mm | 7,5254 | 9,4067 | 50 |
| 50x34 mm | 9,4121 | 11,7652 | 50 |
| 63x45 mm | 17,5852 | 21,9815 | 25 |
| 76x50 mm | 26,0304 | 32,5380 | 25 |
| 89x53 mm | 33,7600 | 42,2000 | 25 |
| 100x65 mm | 37,0007 | 46,2507 | 25 |
| 125x77 mm | 46,2507 | | 25 |

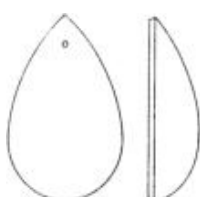

C.0275 lb

| | | | |
|-----------|---------|--------|----|
| 38x23 mm | 3,5332 | 4,4165 | 50 |
| 50x30 mm | 3,9705 | 4,9631 | 50 |
| 63x38 mm | 4,8271 | 6,0338 | 50 |
| 76x46 mm | 6,3837 | 7,9796 | 50 |
| 89x53 mm | 8,8201 | | 50 |
| 100x60 mm | 11,3809 | | 50 |
| 125x76 mm | 29,3807 | | 25 |
| 150x90 mm | 72,6263 | | 10 |

| CRYSTAL | CRYSTAL coated | COLOR | COLOR coated | minimum quantity |
|---------------|--|--|--|---------------------|
| CLEAR | AB AFLAME AMBER ANTIQUÉ GOLD SILVER | ALEXANDRITE AMETHYST AQUAMARINE EMERALD JET RODALIN RUBY SAPPHIRE SMOKE TOPAZ | AB AFLAME AMBER ANTIQUÉ GOLD SILVER | |
| EURO piece | BB BW OG OS VL VM EURO piece | EURO piece | BB BW OG OS VL VM EURO piece | pieces |

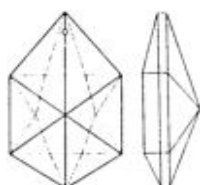

C.0291 la

50x31 mm
63x39 mm
76x49 mm
89x60 mm

8,4151
10,7850
20,1103
23,5503

10,5189
13,4811
25,1378
29,4378

50
50
25
25

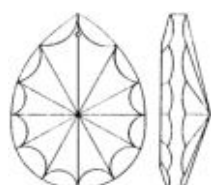

C.0295 la

63x45 mm

13,9105

17,3880

25

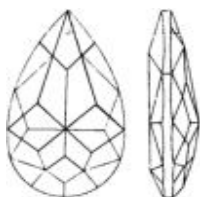

C.0301 lb

38x24 mm
50x31 mm
63x39 mm
76x48 mm
100x68 mm
125x68 mm

2,9367
4,3625
5,9620
9,2288
12,1435
15,1792

3,6707
5,4531
7,4525
11,5363
15,1794

100
100
100
50
50
25

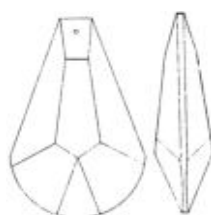

C.0309 la

89x59 mm

25,4109

31,7636

25

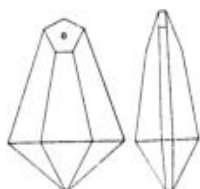

C.0311 la

63x50 mm
76x57 mm
89x64 mm

16,5278
22,4839
25,4109

20,6597
28,1049
31,7636

25
25
25

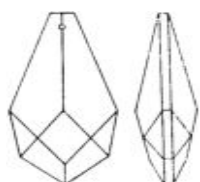

C.0312 la

45x23 mm
63x31 mm
76x38 mm
89x45 mm

5,2877
11,0892
13,7007
19,3190

6,6097
13,8615
17,1259
24,1488

50
50
25
25

| CRYSTAL | CRYSTAL <u>coated</u> | C O L O R | C O L O R <u>coated</u> | minimum quantity |
|---------------|--|--|--|---------------------|
| CLEAR | AB AFLAME AMBER ANTIQUÉ GOLD SILVER | ALEXANDRITE AMETHYST AQUAMARINE EMERALD JET ROSALIN RUBY SAPPHIRE SMOKE TOPAZ | AB AFLAME AMBER ANTIQUÉ GOLD SILVER | |
| | BB BW OG OS VL VM | | BB BW OG OS VL VM | |
| EURO piece | EURO piece | EURO piece | EURO piece | pieces |

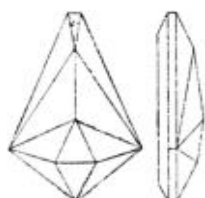

C.0313 la

63x45 mm
76x53 mm

10,8113
13,9105

13,5143
17,3880

50
25

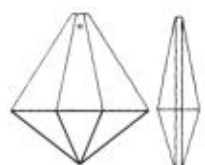

C.0319 la

63x60 mm
76x68 mm

13,9595
17,5615

17,4493
21,9520

25
25

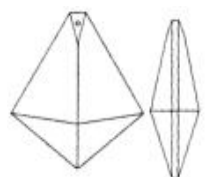

C.0320 la

63x55 mm
76x66 mm

13,6610
15,9651

17,0763
19,9563

25
25

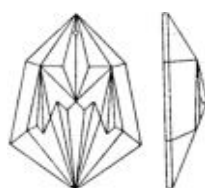

C.0330 lb

50x37 mm
63x46 mm
76x55 mm

5,8980
7,9770
10,3998

7,3722
9,9710
12,9998

50
50
50

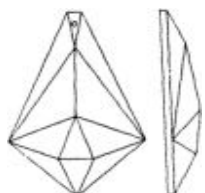

C.0331 lb

63x47 mm
76x53 mm

3,5560
4,9442

4,4451
6,1801

100
100

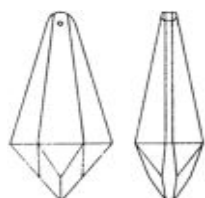

C.0346 la

76x34 mm
165x74 mm

15,9651
61,0511

19,9563

25
25

| CRYSTAL | CRYSTAL coated | COLOR | COLOR coated | minimum quantity |
|---------------|--|--|--|---------------------|
| CLEAR | AB AFLAME AMBER ANTIQUÉ GOLD SILVER | ALEXANDRITE AMETHYST AQUAMARINE EMERALD JET ROSALIN RUBY SAPPHIRE SMOKE TOPAZ | AB AFLAME AMBER ANTIQUÉ GOLD SILVER | |
| EURO piece | BB BW OG OS VL VM EURO piece | EURO piece | BB BW OG OS VL VM EURO piece | pieces |

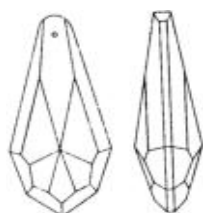

C.0347 la
76x35 mm

22,3820

27,9775

25

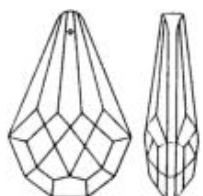

C.0348 la
63x40 mm
89x57 mm
100x64 mm

19,8665

34,3473

43,2098

24,8331

42,9340

54,0122

25

25

25

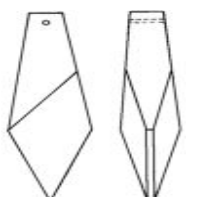

C.0354 la
89x28 mm

17,4665

21,8331

25

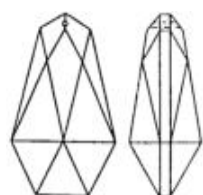

C.0361 la
50x34 mm
63x40 mm
89x53 mm
100x61 mm

11,6971

18,8618

33,9513

54,3219

14,6213

23,5777

42,4390

67,9024

25

25

25

25

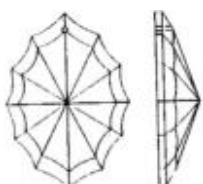

C.0362 lb
63x41 mm

7,5918

9,4897

50

C.0362 la
63x42 mm

11,0589

13,8236

50

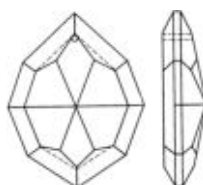

C.0367 la
63x51 mm

11,0589

13,8236

50

| CRYSTAL | CRYSTAL coated | COLOR | COLOR coated | minimum quantity |
|---------------|--|--|--|---------------------|
| CLEAR | AB AFLAME AMBER ANTIQUÉ GOLD SILVER | ALEXANDRITE AMETHYST AQUAMARINE EMERALD JET ROSALIN RUBY SAPPHIRE SMOKE TOPAZ | AB AFLAME AMBER ANTIQUÉ GOLD SILVER | |
| EURO piece | BB BW OG OS VL VM EURO piece | EURO piece | BB BW OG OS VL VM EURO piece | pieces |

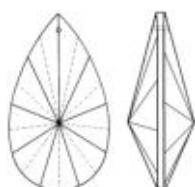

C.0381 la

50x29 mm
63x38 mm

15,2589
19,2262

19,0735
24,0328

25
25

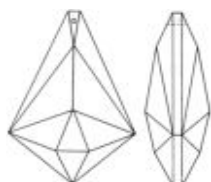

C.0382 la

63x46 mm

19,2262

24,0328

25

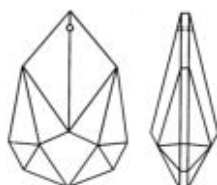

C.0383 la

63x41 mm

19,2262

24,0328

25

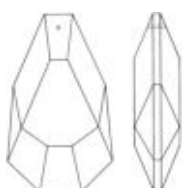

C.0385 la

76x46 mm
100x60 mm

21,7644
27,2055

27,2055
34,0067

25
25

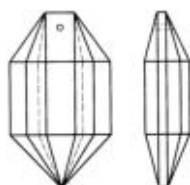

C.0387 lb

57x35 mm

8,8385

11,9321

50

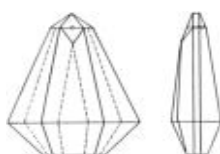

C.0389 la

76x64 mm

21,7644

27,2055

25

| CRYSTAL | CRYSTAL coated | COLOR | COLOR coated | minimum quantity |
|---------------|--|--|--|---------------------|
| CLEAR | AB AFLAME AMBER ANTIQUÉ GOLD SILVER | ALEXANDRITE AMETHYST AQUAMARINE EMERALD JET ROSALIN RUBY SAPPHIRE SMOKE TOPAZ | AB AFLAME AMBER ANTIQUÉ GOLD SILVER | |
| EURO piece | BB BW OG OS VL VM EURO piece | EURO piece | BB BW OG OS VL VM EURO piece | pieces |

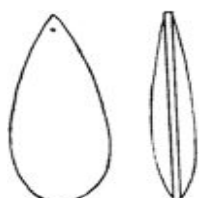

C.0403 lb
125x48 mm
150x59 mm

22,6180
30,1548

25
25

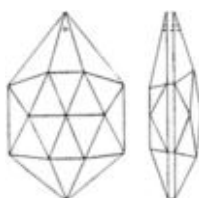

C.0408 lb
38x27 mm
50x35 mm

2,2557
2,8215

2,8198
3,5269

100
100

C.0408 la
50x35 mm
76x53 mm
89x53 mm
100x70 mm

7,8695
21,7644
31,9695
46,9601

9,8369
27,2055
39,9621
58,7001

50
25
25
25

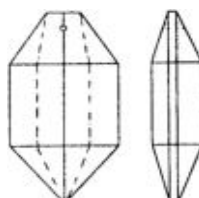

C.0412 la
58x32 mm

10,7076

13,3844

50

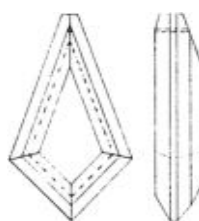

C.0426 la
100x55 mm
125x67 mm

28,2041
44,4412

35,2553

25
25

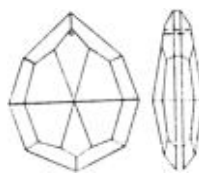

C.0429 la
63x62 mm
76x71 mm

19,9754
28,5364

24,9694
35,6706

25
25

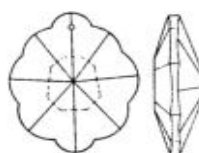

C.0439 la
50x43 mm
63x53 mm
76x62 mm
89x71 mm

9,7330
16,5390
28,1047
47,7585

12,1664
20,6738
35,1310
59,6982

50
25
25
25

| CRYSTAL | CRYSTAL coated | C O L O R | C O L O R coated | minimum quantity |
|---------------|--|--|--|---------------------|
| CLEAR | AB AFLAME AMBER ANTIQUÉ GOLD SILVER | ALEXANDRITE AMETHYST AQUAMARINE EMERALD JET ROSALIN RUBY SAPPHIRE SMOKE TOPAZ | AB AFLAME AMBER ANTIQUÉ GOLD SILVER | |
| EURO piece | BB BW OG OS VL VM EURO piece | EURO piece | BB BW OG OS VL VM EURO piece | pieces |

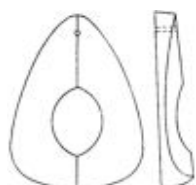

C.0443 la
72x53 mm

11,3590

14,1988

50

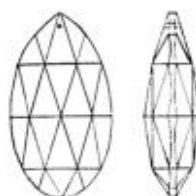

C.0449 la
76x44 mm
89x51 mm

20,7842
26,5065

25,9804
33,1330

25
25

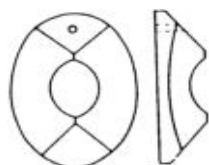

C.0452 la
36x25 mm

4,3093

5,3867

100

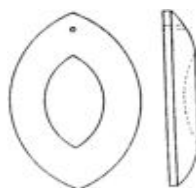

C.0465 lb
63x43 mm

5,8844

7,3554

100

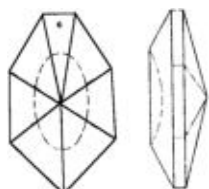

C.0466 la
63x39 mm

10,8871

13,6088

50

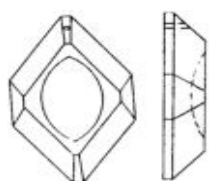

C.0467 lb
50x32 mm

2,7194

3,3993

100

C.0467 la
63x40 mm

10,4014

13,0019

50

| CRYSTAL | CRYSTAL coated | COLOR | COLOR coated | minimum quantity |
|---------------|--|--|--|---------------------|
| CLEAR | AB AFLAME AMBER ANTIQUÉ GOLD SILVER | ALEXANDRITE AMETHYST AQUAMARINE EMERALD JET ROSALIN RUBY SAPPHIRE SMOKE TOPAZ | AB AFLAME AMBER ANTIQUÉ GOLD SILVER | |
| EURO piece | BB BW OG OS VL VM EURO piece | EURO piece | BB BW OG OS VL VM EURO piece | pieces |

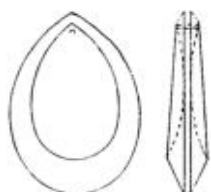

C.0468 lb
63x43 mm

5,2375

6,5470

100

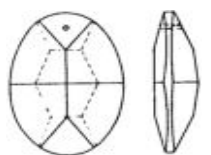

C.0470 la
50x37 mm
63x45 mm

8,9775
15,9045

11,2221
19,8806

50
25

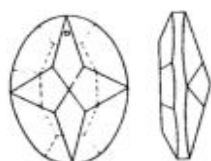

C.0472 la
50x38 mm

9,3195

11,6494

50

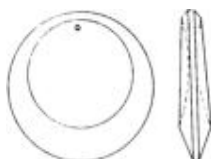

C.0490 lb
40x40 mm

3,9960

4,9950

100

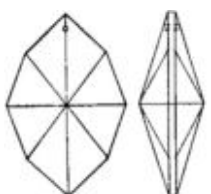

C.0491 lb
63x36 mm

5,5463

6,9328

100

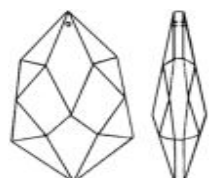

C.0494 la
76x44 mm
89x50 mm

18,0744
29,2464

22,5931
36,5580

25
25

| CRYSTAL | CRYSTAL coated | COLOR | COLOR coated | minimum quantity |
|---------------|--|--|--|---------------------|
| CLEAR | AB AFLAME AMBER ANTIQUÉ GOLD SILVER | ALEXANDRITE AMETHYST AQUAMARINE EMERALD JET ROSALIN RUBY SAPPHIRE SMOKE TOPAZ | AB AFLAME AMBER ANTIQUÉ GOLD SILVER | |
| | BB BW OG OS VL VM | | BB BW OG OS VL VM | |
| EURO piece | EURO piece | EURO piece | EURO piece | pieces |

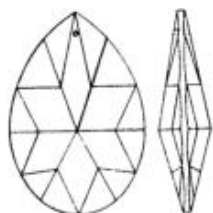

C.0495 la
63x45 mm

| 19,2262 |

| 24,0328 |

| 25

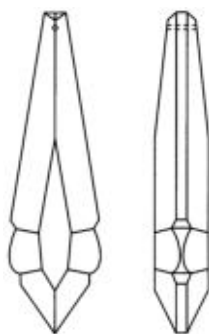

C.0496 la
150x43 mm

| 42,5978 |

| 25

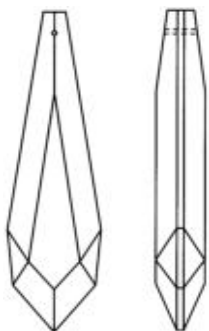

C.0497 la
150x43 mm

| 39,3953 |

| 25

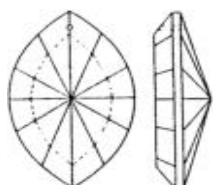

C.0501 la
63x43 mm

| 14,0816 |

| 19,0102 |

| 25

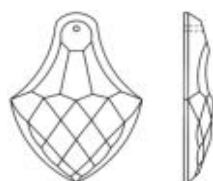

C.0503 lb
63x47 mm

| 3,7772 |

| 4,7213 |

| 100

| CRYSTAL | CRYSTAL coated | COLOR | COLOR coated | minimum quantity |
|---------------|--|--|--|---------------------|
| CLEAR | AB AFLAME AMBER ANTIQUÉ GOLD SILVER | ALEXANDRITE AMETHYST AQUAMARINE EMERALD JET ROSALIN RUBY SAPPHIRE SMOKE TOPAZ | AB AFLAME AMBER ANTIQUÉ GOLD SILVER | |
| EURO piece | BB BW OG OS VL VM EURO piece | EURO piece | BB BW OG OS VL VM EURO piece | pieces |

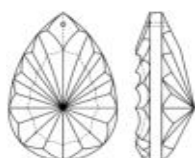

C.0504 lb
76x49 mm

5,1262

6,4078

100

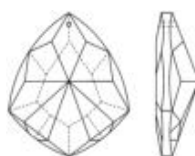

C.0507 lb
63x57 mm

3,7772

4,7213

100

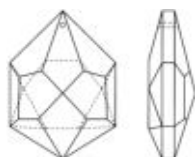

C.0508 lb
38x27 mm
63x43 mm

2,6663
3,7772

3,3329
4,7213

100
100

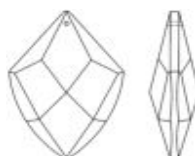

C.0509 lb
38x27 mm

2,6663

3,3329

100

C.0509 la
63x45 mm
76x54 mm
89x65 mm

6,0966
8,7219
9,9645

7,6209
10,9024
12,4559

50
50
50

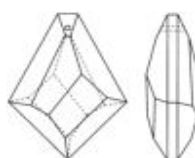

C.0510 la
63x48 mm
76x57 mm
89x67 mm

6,0966
7,7939
10,6489

7,6209
9,7424
13,3111

50
50
50

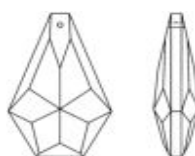

C.0511 la
63x41 mm
76x42 mm

6,0966
7,7939

7,6209
9,7424

50
50

| CRYSTAL | CRYSTAL coated | COLOR | COLOR coated | minimum quantity |
|---------------|--|--|--|---------------------|
| CLEAR | AB AFLAME AMBER ANTIQUÉ GOLD SILVER | ALEXANDRITE AMETHYST AQUAMARINE EMERALD JET ROSALIN RUBY SAPPHIRE SMOKE TOPAZ | AB AFLAME AMBER ANTIQUÉ GOLD SILVER | |
| | BB BW OG OS VL VM | | BB BW OG OS VL VM | |
| EURO piece | EURO piece | EURO piece | EURO piece | pieces |

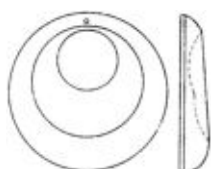

C.0516 lb
60x60 mm

9,1022

11,3779

50

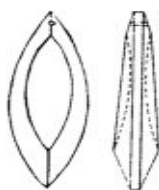

C.0518 lb
89x23 mm

5,0725

6,3405

100

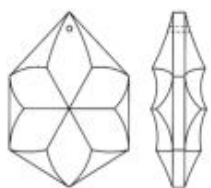

C.0574 lb
50x36 mm
63x45 mm

3,1745
5,7333

3,9681
7,1665

50
50

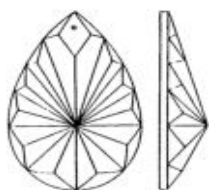

C.0587 lb
76x49 mm

9,4536

11,8171

50

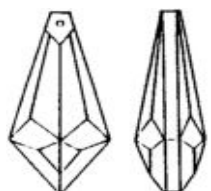

C.0589 lb
50x24 mm

4,3152

5,3939

100

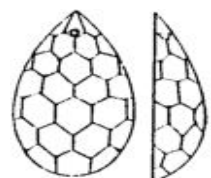

C.0594 la
38x23 mm

8,3752

10,4691

50

| CRYSTAL | CRYSTAL coated | COLOR | COLOR coated | minimum quantity |
|---------------|--|--|--|---------------------|
| CLEAR | AB AFLAME AMBER ANTIQUÉ GOLD SILVER | ALEXANDRITE AMETHYST AQUAMARINE EMERALD JET ROSALIN RUBY SAPPHIRE SMOKE TOPAZ | AB AFLAME AMBER ANTIQUÉ GOLD SILVER | |
| EURO piece | BB BW OG OS VL VM EURO piece | EURO piece | BB BW OG OS VL VM EURO piece | pieces |



C.0595 la
89x59 mm

12,3025

15,3780

25

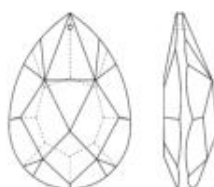

C.0596 la
76x54 mm
89x60 mm
100x70 mm

26,0304
33,7600
37,0007

32,5380
42,2000
46,2507

25
25
25

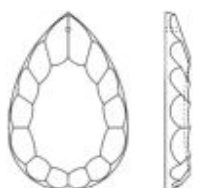

C.0597 lb
76x50 mm

9,4536

11,8171

50

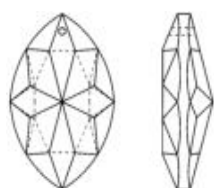

C.0598 lb
45x29 mm
50x33 mm

2,9367
4,3625

3,6707
5,4531

100
100

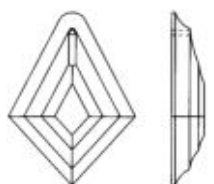

C.0599 lb
50x36 mm

5,8734

7,3419

100

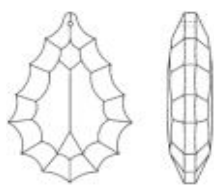

C.0600 la
76x52 mm

26,0304

32,5380

25

| CRYSTAL | CRYSTAL coated | COLOR | COLOR coated | minimum quantity |
|---------------|-------------------|---------------|-----------------|---------------------|
| CLEAR | AB | ALEXANDRITE | AB | |
| | AFLAME | AMETHYST | AFLAME | |
| | AMBER | AQUAMARINE | AMBER | |
| | ANTIQUÉ | EMERALD | ANTIQUÉ | |
| | GOLD | JET | GOLD | |
| | SILVER | ROSA LIN | SILVER | |
| | BB | RUBY | BB | |
| | BW | SAPPHIRE | BW | |
| | OG | SMOKE | OG | |
| | OS | TOPAZ | OS | |
| VL | | VL | | |
| VM | | VM | | |
| EURO piece | EURO piece | EURO piece | EURO piece | pieces |

TWO-HOLE ALMONDS

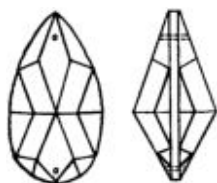

C.0255 lb

20x13 mm
25x15 mm
30x18 mm
35x20 mm

1,8695
1,9546
2,1445
2,6000

2,3369
2,4434
2,6808
3,2499

250
250
250
250

C.0255 la

30x18 mm
35x20 mm
40x23 mm

5,3616
6,4999
6,6381

6,7019
8,1249
8,2976

50
50
50

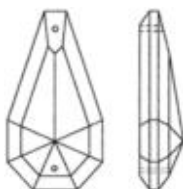

C.0256 la

38x20 mm

7,1744

8,9680

50

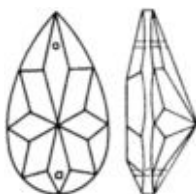

C.0257 lb

20x14 mm

1,5580

1,9473

250

C.0257 la

25x17 mm
30x21 mm
35x24 mm
40x27 mm
45x32 mm

3,9092
4,5136
5,5311
7,0306
7,6746

4,8865
5,6419
6,9140
8,7882
9,5933

100
100
100
50
50

| CRYSTAL | CRYSTAL coated | COLOR | COLOR coated | minimum quantity |
|---------------|--|--|--|---------------------|
| CLEAR | AB AFLAME AMBER ANTIQUÉ GOLD SILVER | ALEXANDRITE AMETHYST AQUAMARINE EMERALD JET ROSALIN RUBY SAPPHIRE SMOKE TOPAZ | AB AFLAME AMBER ANTIQUÉ GOLD SILVER | |
| | BB BW OG OS VL VM | | BB BW OG OS VL VM | |
| EURO piece | EURO piece | EURO piece | EURO piece | pieces |

PENDELOQUES



C.0209 lb

63x43 mm
76x49 mm
89x58 mm
100x65 mm
125x82 mm

3,7772
5,0725
7,4426
15,3662
28,4098

4,7213
6,3405
9,3031
19,2079

100
100
50
25
25

C.0209 la

63x43 mm
76x49 mm
89x58 mm
100x65 mm
125x82 mm
150x95 mm

5,5423
7,0854
9,9239
18,3670
34,3226
48,5050

6,9281
8,8567
12,4048
22,9588

50
50
50
25
25
25

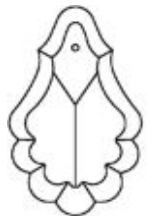

C.0210 lb

63x38 mm
76x51 mm

3,7772
5,0725

4,7213
6,3405

100
100

C.0210 la

63x38 mm
76x51 mm
89x52 mm
100x62 mm

5,5423
7,0854
9,9239
18,3670

6,9281
8,8567
12,4048
22,9588

50
50
50
25



C.0211 lb

89x51 mm

7,4426

9,3031

50

C.0211 la

89x51 mm

9,9239

12,4048

50

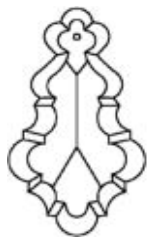

C.0212 lb

63x39 mm
76x45 mm
89x52 mm

3,7772
5,0725
7,4426

4,7213
6,3405
9,3031

100
100
50

C.0212 la

63x39 mm
76x45 mm
89x52 mm
100x58 mm
115x67 mm

5,5423
7,0854
9,9239
18,3670
26,5781

6,9281
8,8567
12,4048
22,9588

50
50
50
25
25

| CRYSTAL | CRYSTAL coated | COLOR | COLOR coated | minimum quantity |
|---------------|--|--|--|---------------------|
| CLEAR | AB AFLAME AMBER ANTIQUÉ GOLD SILVER | ALEXANDRITE AMETHYST AQUAMARINE EMERALD JET ROBALIN RUBY SAPPHIRE SMOKE TOPAZ | AB AFLAME AMBER ANTIQUÉ GOLD SILVER | |
| EURO piece | EURO piece | EURO piece | EURO piece | pieces |



C.0215 lb

45x32 mm
50x35 mm
63x45 mm
76x54 mm
89x62 mm

2,6663
2,9628
3,7772
5,0725
7,4426

3,3329
3,7035
4,7213
6,3405
9,3031

100
100
100
100
50

C.0215 la

63x45 mm
76x54 mm
89x62 mm

5,5423
7,0854
9,9239

6,9281
8,8567
12,4048

50
50
50



C.0216 lb

50x34 mm
63x41 mm
76x50 mm
89x56 mm
100x64 mm

2,9628
3,7772
5,0725
7,4426
13,5106

3,7035
4,7213
6,3405
9,3031
16,8883

100
100
100
50
25

C.0216 la

63x41 mm
76x50 mm
89x56 mm
100x64 mm
115x71 mm
125x75 mm

5,5423
7,0854
9,9239
18,3670
26,5781
34,3226

6,9281
8,8567
12,4048
22,9588

50
50
50
25
25
25



C.0217 lb

63x44 mm
76x52 mm
89x55 mm
100x63 mm

3,7772
5,0725
7,4426
15,3664

4,7213
6,3405
9,3031
19,2079

100
100
50
25

C.0217 la

63x44 mm
76x52 mm
89x55 mm
100x63 mm

5,5423
7,0854
9,9239
18,3670

6,9281
8,8567
12,4048
22,9588

50
50
50
25



C.0218 lb

63x38 mm
76x48 mm

3,7772
5,0725

4,7213
6,3405

100
100

C.0218 la

63x38 mm
76x48 mm
89x55 mm
100x63 mm
125x64 mm

5,5423
7,0854
9,9239
18,3670
34,3226

6,9281
8,8567
12,4048
22,9588

50
50
50
25
25

| CRYSTAL | CRYSTAL coated | COLOR | COLOR coated | minimum quantity |
|---------------|--|---|--|---------------------|
| CLEAR | AB AFLAME AMBER ANTIQUÉ GOLD SILVER | ALEXANDRITE AMETHYST AQUAMARINE EMERALD JET ROSA LIN RUBY SAPPHIRE SMOKE TOPAZ | AB AFLAME AMBER ANTIQUÉ GOLD SILVER | |
| EURO piece | EURO piece | EURO piece | EURO piece | pieces |



C.0225 lb

63x41 mm
76x50 mm
89x58 mm

3,7772
5,0725
7,4426

4,7213
6,3405
9,3031

100
100
50

C.0225 la

63x41 mm
76x50 mm
89x58 mm
115x70 mm

5,5423
7,0854
9,9239
26,5781

6,9281
8,8567
12,4048

50
50
50
25

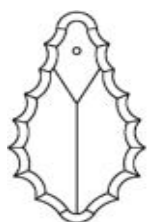

C.0231 lb

50x28 mm

2,9628

3,7035

100

C.0231 la

76x45 mm

7,0854

8,8567

50



C.0237 la

63x41 mm
76x51 mm
89x63 mm
115x79 mm

5,5423
7,0854
9,9239
26,5781

6,9281
8,8567
12,4048

50
50
25
25



C.0239 la

100x63 mm
115x71 mm
125x81 mm

17,6966
25,8303
33,1006

22,1210

25
25
25

| CRYSTAL | CRYSTAL coated | COLOR | COLOR coated | minimum quantity |
|---------------|--|--|--|---------------------|
| CLEAR | AB AFLAME AMBER ANTIQUÉ GOLD SILVER | ALEXANDRITE AMETHYST AQUAMARINE EMERALD JET ROSALIN RUBY SAPPHIRE SMOKE TOPAZ | AB AFLAME AMBER ANTIQUÉ GOLD SILVER | |
| EURO piece | BB BW OG OS VL VM EURO piece | EURO piece | BB BW OG OS VL VM EURO piece | pieces |

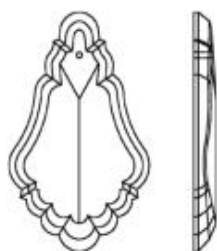

C.0253 la
100x64 mm

17,2434

21,5542

25

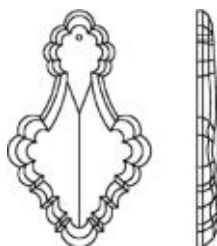

C.0272 la
100x64 mm
125x78 mm

17,2434
33,1006

21,5542

25
25

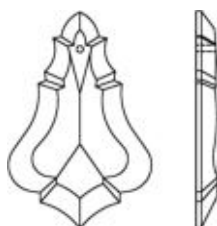

C.0274 lb
63x43 mm
89x56 mm

3,7772
7,4426

4,7213
9,3031

100
50

C.0274 la
63x43 mm
89x56 mm

5,5423
9,9239

6,9281
12,4048

50
50

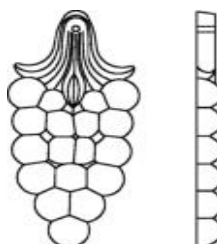

C.0276 lb
89x41 mm
100x52 mm

10,9699
16,5268

13,7125
20,6587

25
25

| CRYSTAL | CRYSTAL coated | COLOR | COLOR coated | minimum quantity |
|---------------|--|--|--|---------------------|
| CLEAR | AB AFLAME AMBER ANTIQUÉ GOLD SILVER | ALEXANDRITE AMETHYST AQUAMARINE EMERALD JET RODALIN RUBY SAPPHIRE SMOKE TOPAZ | AB AFLAME AMBER ANTIQUÉ GOLD SILVER | |
| | BB BW OG OS VL VM | | BB BW OG OS VL VM | |
| EURO piece | EURO piece | EURO piece | EURO piece | pieces |



C.0280 1a

63x41 mm
76x48 mm
89x61 mm
100x66 mm

5,5423
7,0854
9,9239
18,3670

6,9281
8,8567
12,4046
22,9588

50
50
50
25

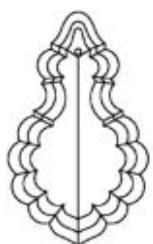

C.0281 1a

76x45 mm
89x53 mm
125x65 mm

7,0854
9,9239
30,1152

8,8567
12,4048

50
50
25

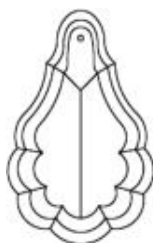

C.0282 1b

63x39 mm
76x51 mm
89x58 mm

3,7772
5,0725
7,4426

4,7213
6,3405
9,3031

100
100
50

C.0282 1a

63x39 mm
76x51 mm
89x58 mm
100x64 mm

5,5423
7,0854
9,9239
18,3670

6,9281
8,8567
12,4048
22,9588

50
50
50
25

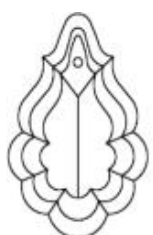

C.0289 1a

63x44 mm
76x51 mm

5,5423
7,0854

6,9281
8,8567

50
50

| CRYSTAL | CRYSTAL coated | COLOR | COLOR coated | minimum quantity |
|---------------|--|--|--|---------------------|
| CLEAR | AB AFLAME AMBER ANTIQUÉ GOLD SILVER | ALEXANDRITE AMETHYST AQUAMARINE EMERALD JET ROSALIN RUBY SAPPHIRE SMOKE TOPAZ | AB AFLAME AMBER ANTIQUÉ GOLD SILVER | |
| | BB BW OG OS VL VM | | BB BW OG OS VL VM | |
| EURO piece | EURO piece | EURO piece | EURO piece | pieces |

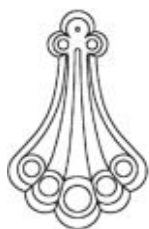

C.0360 lb
100x63 mm
125x79 mm

14,5487
25,2901

18,1858

25
25



C.0366 lb
100x64 mm

19,5736

24,4672

25

C.0366 la
100x64 mm

23,6754

29,5942

25



C.0375 lb
89x56 mm

9,9125

12,3907

25



C.0376 lb
50x38 mm
63x43 mm
76x55 mm
100x70 mm

2,9628
3,7772
5,0725
15,3664

3,7035
4,7213
6,3405
19,2079

100
100
50
25

| CRYSTAL | CRYSTAL coated | COLOR | COLOR coated | minimum quantity |
|---------------|--|--|--|---------------------|
| CLEAR | AB AFLAME AMBER ANTIQUÉ GOLD SILVER | ALEXANDRITE AMETHYST AQUAMARINE EMERALD JET ROSALIN RUBY SAPPHIRE SMOKE TOPAZ | AB AFLAME AMBER ANTIQUÉ GOLD SILVER | |
| EURO piece | BB BW OG OS VL VM EURO piece | EURO piece | BB BW OG OS VL VM EURO piece | pieces |

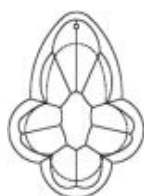

C.0384 lb
76x52 mm

7,2176

9,0219

50

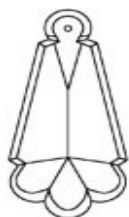

C.0404 la
100x46 mm
125x57 mm

22,9109
35,8069

28,6387

25
25

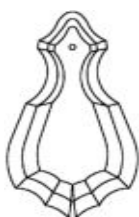

C.0405 la
100x54 mm

22,9109

28,6387

25



C.0440 la
63x37 mm
76x46 mm
89x53 mm

5,5423
7,0854
9,9239

6,9281
8,8567
12,4048

50
50
50

| CRYSTAL | CRYSTAL coated | COLOR | COLOR coated | minimum quantity |
|---------------|--|--|--|---------------------|
| CLEAR | AB AFLAME AMBER ANTIQUÉ GOLD SILVER | ALEXANDRITE AMETHYST AQUAMARINE EMERALD JET RODALIN RUBY SAPPHIRE SMOKE TOPAZ | AB AFLAME AMBER ANTIQUÉ GOLD SILVER | |
| | BB BW OG OS VL VM | | BB BW OG OS VL VM | |
| EURO piece | EURO piece | EURO piece | EURO piece | pieces |

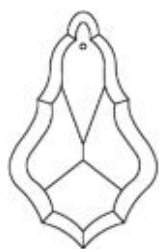

C.0441 la
100x62 mm

18,3670

22,9588

25

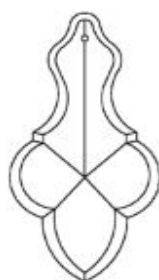

C.0455 la
150x78 mm

48,5050

25

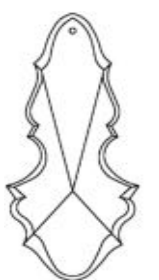

C.0456 la
150x67 mm

48,5050

25

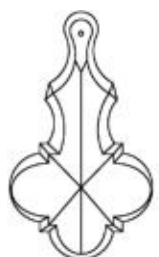

C.0457 lb
125x73 mm

29,9226

25

C.0457 la
125x73 mm

42,2049

25

| CRYSTAL | CRYSTAL <u>coated</u> | C O L O R | C O L O R <u>coated</u> | minimum quantity |
|---------------|--|--|--|---------------------|
| CLEAR | AB AFLAME AMBER ANTIQUÉ GOLD SILVER | ALEXANDRITE AMETHYST AQUAMARINE EMERALD JET RODALIN RUBY SAPPHIRE SMOKE TOPAZ | AB AFLAME AMBER ANTIQUÉ GOLD SILVER | |
| | BB BW OG OS VL VM | | BB BW OG OS VL VM | |
| EURO piece | EURO piece | EURO piece | EURO piece | pieces |

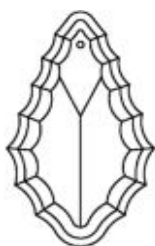

C.0459 lb

63x39 mm
76x46 mm
89x53 mm
100x59 mm

3,7772
5,0725
7,4426
15,3664

4,7213
6,3405
9,3031
19,2079

100
100
50
25

C.0459 la

63x39 mm
76x46 mm
89x53 mm
100x59 mm
120x68 mm

5,5423
7,0854
9,9239
18,3670
31,1991

6,9281
8,8567
12,4046
22,9588

50
50
50
25
25

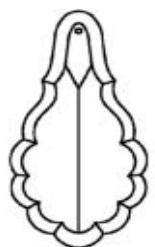

C.0460 la

125x64 mm

30,1152

25

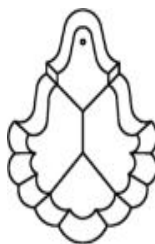

C.0462 la

100x71 mm

18,5031

23,1288

25

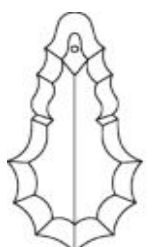

C.0469 la

76x38 mm

7,1933

8,9916

50

| CRYSTAL | CRYSTAL coated | COLOR | COLOR coated | minimum quantity |
|---------------|--|--|--|---------------------|
| CLEAR | AB AFLAME AMBER ANTIQUÉ GOLD SILVER | ALEXANDRITE AMETHYST AQUAMARINE EMERALD JET RODALIN RUBY SAPPHIRE SMOKE TOPAZ | AB AFLAME AMBER ANTIQUÉ GOLD SILVER | |
| | BB BW OG OS VL VM | | BB BW OG OS VL VM | |
| EURO piece | EURO piece | EURO piece | EURO piece | pieces |

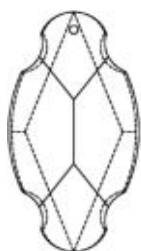

C.0473 la
76x38 mm

7,0854

8,8567

50

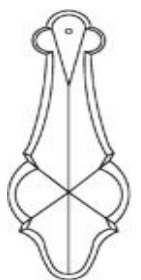

C.0492 la
115x41 mm
150x53 mm

20,4804
34,4058

25
25

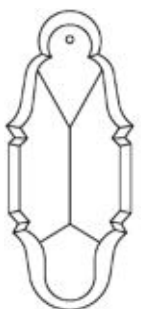

C.0515 la
100x28 mm
125x35 mm

18,1215
24,7254

22,6518

25
25

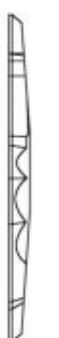

C.0517 la
160x40 mm

41,5288

25

| CRYSTAL | CRYSTAL coated | COLOR | COLOR coated | minimum quantity |
|---------------|--|--|--|---------------------|
| CLEAR | AB AFLAME AMBER ANTIQUÉ GOLD SILVER | ALEXANDRITE AMETHYST AQUAMARINE EMERALD JET RODALIN RUBY SAPPHIRE SMOKE TOPAZ | AB AFLAME AMBER ANTIQUÉ GOLD SILVER | |
| EURO piece | BB BW OG OS VL VM EURO piece | EURO piece | BB BW OG OS VL VM EURO piece | pieces |

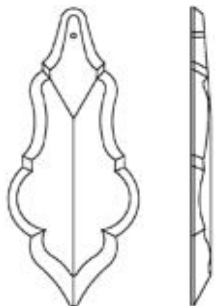

C.0550 la
150x67 mm

41,5288

25

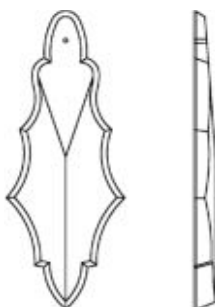

C.0552 la
150x55 mm

41,5288

25

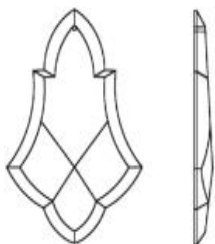

C.0558 la
100x57 mm
115x67 mm

19,2302
26,9406

24,0376

25
25

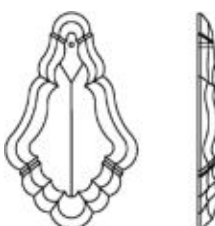

C.0559 lb
76x52 mm

5,0725

6,3405

100

C.0559 la
76x52 mm
100x63 mm

7,0854
18,3670

8,8567
22,9588

50
25

| CRYSTAL | CRYSTAL coated | COLOR | COLOR coated | minimum quantity |
|---------------|--|--|--|---------------------|
| CLEAR | AB AFLAME AMBER ANTIQUÉ GOLD SILVER | ALEXANDRITE AMETHYST AQUAMARINE EMERALD JET RODALIN RUBY SAPPHIRE SMOKE TOPAZ | AB AFLAME AMBER ANTIQUÉ GOLD SILVER | |
| EURO piece | BB BW OG OS VL VM EURO piece | EURO piece | BB BW OG OS VL VM EURO piece | pieces |

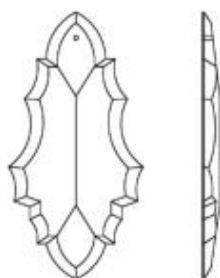

C.0560 la
125x54 mm
150x67 mm

22,4329
41,5288

25
25

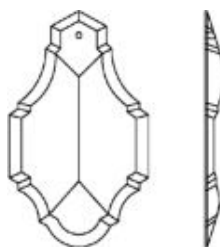

C.0561 la
76x42 mm
89x46 mm
100x48 mm

7,0854
9,9239
18,3670

8,8567
12,4048
22,9588

50
50
25

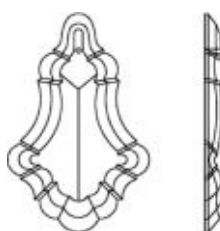

C.0562 la
100x65 mm

18,3670

22,9588

25

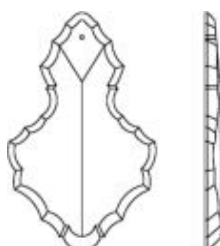

C.0563 la
150x98 mm

48,5050

25

| CRYSTAL | CRYSTAL coated | COLOR | COLOR coated | minimum quantity |
|---------------|--|--|--|---------------------|
| CLEAR | AB AFLAME AMBER ANTIQUÉ GOLD SILVER | ALEXANDRITE AMETHYST AQUAMARINE EMERALD JET RODALIN RUBY SAPPHIRE SMOKE TOPAZ | AB AFLAME AMBER ANTIQUÉ GOLD SILVER | |
| | BB BW OG OS VL VM | | BB BW OG OS VL VM | |
| EURO piece | EURO piece | EURO piece | EURO piece | pieces |

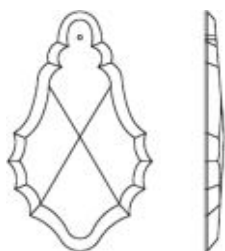

C.0564 la
150x92 mm

48,5050

25

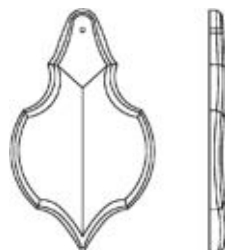

C.0565 la
150x90 mm

48,5050

25

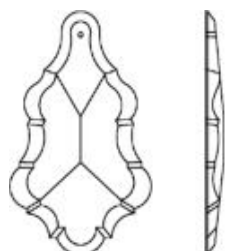

C.0566 la
125x72 mm

34,3226

25

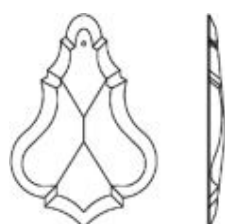

C.0567 la
125x86 mm

34,3226

25

| CRYSTAL | CRYSTAL coated | COLOR | COLOR coated | minimum quantity |
|---------------|--|--|--|---------------------|
| CLEAR | AB AFLAME AMBER ANTIQUÉ GOLD SILVER | ALEXANDRITE AMETHYST AQUAMARINE EMERALD JET RODALIN RUBY SAPPHIRE SMOKE TOPAZ | AB AFLAME AMBER ANTIQUÉ GOLD SILVER | |
| EURO piece | BB BW OG OS VL VM EURO piece | EURO piece | BB BW OG OS VL VM EURO piece | pieces |

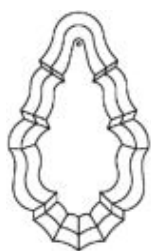

C.0569 la
135x77 mm

41,5288

25



C.0570 la
140x87 mm

41,5288

25



C.0571 la
170x90 mm

48,5050

25

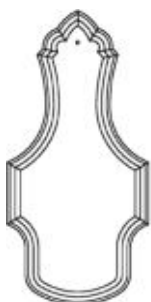

C.0572 la
170x80 mm

48,5050

25

| CRYSTAL | CRYSTAL <u>coated</u> | C O L O R | C O L O R <u>coated</u> | minimum quantity |
|---------------|--|---|--|---------------------|
| CLEAR | AB AFLAME AMBER ANTIQUÉ GOLD SILVER | ALEXANDRITE AMETHYST AQUAMARINE EMERALD JET ROSA LIN RUBY SAPPHIRE SMOKE TOPAZ | AB AFLAME AMBER ANTIQUÉ GOLD SILVER | |
| | BB BW OG OS VL VM | | BB BW OG OS VL VM | |
| EURO piece | EURO piece | EURO piece | EURO piece | pieces |

FRUITS & LEAVES



C.0324 lb

| | | | |
|-------|---------|---------|----|
| 33 mm | 10,4205 | 13,0256 | 50 |
| 40 mm | 11,3194 | 14,1492 | 50 |
| 45 mm | 15,6611 | 19,5763 | 50 |

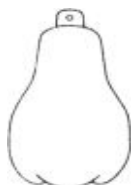

C.0350 lb

| | | | |
|-------|---------|---------|----|
| 40 mm | 6,3791 | 7,9739 | 50 |
| 50 mm | 8,3999 | 10,5000 | 50 |
| 60 mm | 11,9555 | 14,9445 | 50 |
| 70 mm | 18,3481 | 22,9351 | 50 |

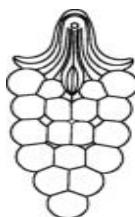

C.0276 lb

| | | | |
|-----------|---------|---------|----|
| 89x41 mm | 10,9699 | 13,7125 | 25 |
| 100x52 mm | 16,5268 | 20,6587 | 25 |

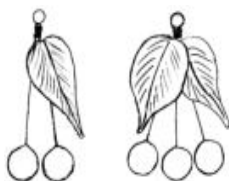

C.0724

| | | | |
|---------------------------------|---------|--|---|
| 58 mm CRYSTAL (2 cherries) | 10,3578 | | 1 |
| 58 mm FROSTED (2 cherries) | 10,3578 | | 1 |
| 58 mm EMERALD (2 cherries) | 10,3578 | | 1 |
| 58 mm AMETHYST (2 cherries) | 10,3578 | | 1 |
| 58 mm RUBY (2 cherries) | 10,3578 | | 1 |
| 58 mm CRYSTAL (3 cherries) | 14,1422 | | 1 |
| 58 mm FROSTED (3 cherries) | 14,1422 | | 1 |
| 58 mm EMERALD (3 cherries) | 14,1422 | | 1 |
| 58 mm AMETHYST (3 cherries) | 14,1422 | | 1 |
| 58 mm RUBY (3 cherries) | 14,1422 | | 1 |

| CRYSTAL | CRYSTAL <u>coated</u> | C O L O R | C O L O R <u>coated</u> | minimum quantity |
|---------------|--|--|--|---------------------|
| CLEAR | AB AFLAME AMBER ANTIQUÉ GOLD SILVER | ALEXANDRITE AMETHYST AQUAMARINE EMERALD JET ROSALIN RUBY SAPPHIRE SMOKE TOPAZ | AB AFLAME AMBER ANTIQUÉ GOLD SILVER | |
| | BB BW OG OS VL VM | | BB BW OG OS VL VM | |
| EURO piece | EURO piece | EURO piece | EURO piece | pieces |



C.0220 lb - right bent

| | | | |
|----------|--------|--------|-----|
| 35x25 mm | 1,4080 | 1,6837 | 250 |
| 42x27 mm | 1,7723 | 1,9496 | 250 |
| 60x46 mm | 2,5570 | 3,0465 | 50 |



C.0220 lb - left bent

| | | | |
|----------|--------|--------|-----|
| 35x25 mm | 1,4080 | 1,6837 | 250 |
| 42x27 mm | 1,7723 | 1,9496 | 250 |
| 60x46 mm | 2,5570 | 3,0465 | 50 |



C.0242 la

| | | | |
|----------|--------|---------|----|
| 30x22 mm | 4,5136 | 5,6419 | 50 |
| 35x25 mm | 5,5311 | 6,9140 | 50 |
| 40x26 mm | 7,0306 | 8,7882 | 50 |
| 45x31 mm | 7,6746 | 9,5933 | 50 |
| 50x35 mm | 8,8964 | 11,1206 | 50 |

| CRYSTAL | CRYSTAL coated | COLOR | COLOR coated | minimum quantity |
|---------------|--|--|--|---------------------|
| CLEAR | AB AFLAME AMBER ANTIQUÉ GOLD SILVER | ALEXANDRITE AMETHYST AQUAMARINE EMERALD JET RODALIN RUBY SAPPHIRE SMOKE TOPAZ | AB AFLAME AMBER ANTIQUÉ GOLD SILVER | |
| EURO piece | BB BW OG OS VL VM EURO piece | EURO piece | BB BW OG OS VL VM EURO piece | pieces |

CROWNS

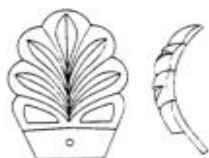

C.0221 lb
76x54 mm

10,1298

12,6622

1

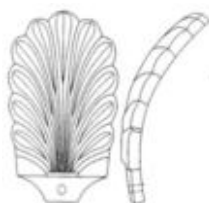

C.0227 lb
100x67 mm
130x69 mm
160x71 mm

15,7542

19,6928

23,6313

1

1

1

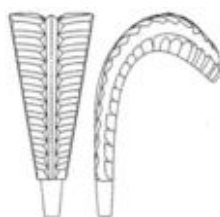

C.0228 lb
100x50 mm
150x60 mm
200x70 mm

14,7696

26,0653

37,9343

1

1

1

| CRYSTAL | CRYSTAL coated | COLOR | COLOR coated | minimum quantity |
|---------------|--|--|--|---------------------|
| CLEAR | AB AFLAME AMBER ANTIQUÉ GOLD SILVER | ALEXANDRITE AMETHYST AQUAMARINE EMERALD JET RODALIN RUBY SAPPHIRE SMOKE TOPAZ | AB AFLAME AMBER ANTIQUÉ GOLD SILVER | |
| | BB BW OG OS VL VM | | BB BW OG OS VL VM | |
| EURO piece | EURO piece | EURO piece | EURO piece | pieces |

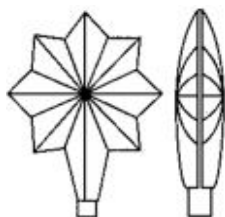

C.0305 la
89x72 mm

11,6363

1



C.0323 lb
55x60 mm

22,0554

27,5691

1

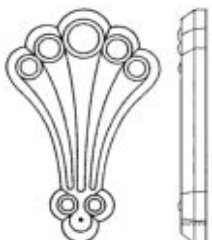

C.0360 lb
100x63 mm
125x79 mm

14,5487
25,2901

18,1858

25
25

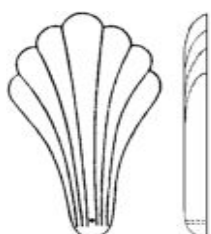

C.0375 lb
89x56 mm

9,9125

12,3907

25

| CRYSTAL | CRYSTAL coated | COLOR | COLOR coated | minimum quantity |
|---------------|--|--|--|---------------------|
| CLEAR | AB AFLAME AMBER ANTIQUÉ GOLD SILVER | ALEXANDRITE AMETHYST AQUAMARINE EMERALD JET RODALIN RUBY SAPPHIRE SMOKE TOPAZ | AB AFLAME AMBER ANTIQUÉ GOLD SILVER | |
| EURO piece | BB BW OG OS VL VM EURO piece | EURO piece | BB BW OG OS VL VM EURO piece | pieces |

SPIKES

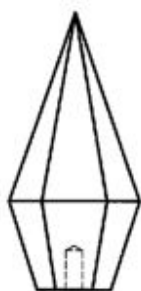

C.0278 la

| | | | | |
|-------|--------|--|--|---|
| 38 mm | 4,4757 | | | 1 |
| 50 mm | 5,6111 | | | 1 |
| 63 mm | 7,0121 | | | 1 |
| 76 mm | 8,5512 | | | 1 |

(hole: 4mm)



C.0285 la

| | | | | |
|--------|---------|--|--|---|
| 225 mm | 20,3776 | | | 1 |
|--------|---------|--|--|---|

| CRYSTAL | CRYSTAL <u>coated</u> | C O L O R | C O L O R <u>coated</u> | minimum quantity |
|---------------|--|--|--|---------------------|
| CLEAR | AB AFLAME AMBER ANTIQUÉ GOLD SILVER | ALEXANDRITE AMETHYST AQUAMARINE EMERALD JET RODALIN RUBY SAPPHIRE SMOKE TOPAZ | AB AFLAME AMBER ANTIQUÉ GOLD SILVER | |
| EURO piece | BB BW OG OS VL VM EURO piece | EURO piece | BB BW OG OS VL VM EURO piece | pieces |



C.0287 la

| | | | | |
|--------|---------|--|--|---|
| 76 mm | 9,6315 | | | 1 |
| 100 mm | 12,0484 | | | 1 |
| 125 mm | 14,4473 | | | 1 |
| 150 mm | 22,1991 | | | 1 |
| 175 mm | 23,0047 | | | 1 |
| 200 mm | 27,0149 | | | 1 |
| 250 mm | 32,9943 | | | 1 |



C.0297 la

| | | | | |
|--------|---------|--|--|---|
| 125 mm | 18,5112 | | | 1 |
| 150 mm | 28,3039 | | | 1 |
| 175 mm | 31,4449 | | | 1 |
| 200 mm | 38,7231 | | | 1 |
| 250 mm | 47,2626 | | | 1 |

| CRYSTAL | CRYSTAL coated | COLOR | COLOR coated | minimum quantity |
|---------------|--|--|--|---------------------|
| CLEAR | AB AFLAME AMBER ANTIQUÉ GOLD SILVER | ALEXANDRITE AMETHYST AQUAMARINE EMERALD JET RODALIN RUBY SAPPHIRE SMOKE TOPAZ | AB AFLAME AMBER ANTIQUÉ GOLD SILVER | |
| EURO piece | BB BW OG OS VL VM EURO piece | EURO piece | BB BW OG OS VL VM EURO piece | pieces |



C.0279 la

100 mm
150 mm

19,6487
32,7146

1
1

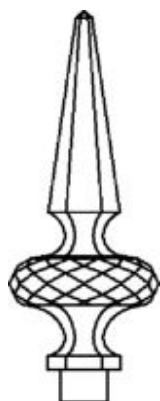

C.0290 la

150 mm

33,2465

1

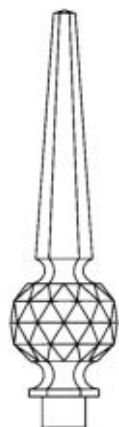

C.0296 la

125 mm
150 mm
175 mm
200 mm
250 mm

24,0252
28,1427
33,2315
46,0614
72,3709

1
1
1
1
1

| CRYSTAL | CRYSTAL <u>coated</u> | C O L O R | C O L O R <u>coated</u> | minimum quantity |
|---------------|--|--|--|---------------------|
| CLEAR | AB AFLAME AMBER ANTIQUÉ GOLD SILVER | ALEXANDRITE AMETHYST AQUAMARINE EMERALD JET RODALIN RUBY SAPPHIRE SMOKE TOPAZ | AB AFLAME AMBER ANTIQUÉ GOLD SILVER | |
| EURO piece | BB BW OG OS VL VM EURO piece | EURO piece | BB BW OG OS VL VM EURO piece | pieces |

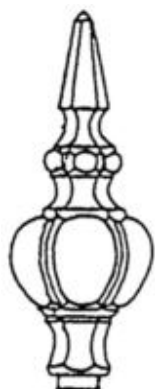

C.0553 lb

| | | | | |
|--------|---------|--|--|---|
| 130 mm | 30,2610 | | | 1 |
| 150 mm | 37,7454 | | | 1 |
| 180 mm | 49,9191 | | | 1 |

(hollow)



C.0557 lb

| | | | | |
|--------|----------|--|--|---|
| 130 mm | 29,6835 | | | 1 |
| 150 mm | 34,7424 | | | 1 |
| 180 mm | 40,8408 | | | 1 |
| 230 mm | 53,8461 | | | 1 |
| 280 mm | 75,5832 | | | 1 |
| 360 mm | 146,0703 | | | 1 |

(hollow)

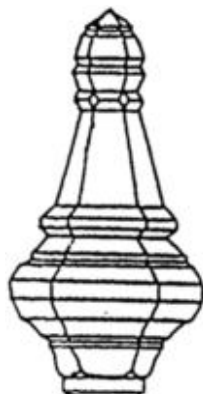

C.0554 lb

| | | | | |
|--------|---------|--|--|---|
| 150 mm | 39,4347 | | | 1 |
| 180 mm | 45,9333 | | | 1 |
| 230 mm | 60,1121 | | | 1 |
| 280 mm | 77,6879 | | | 1 |

(hollow)

| CRYSTAL | CRYSTAL <u>coated</u> | C O L O R | C O L O R <u>coated</u> | minimum quantity |
|---------------|--|--|--|---------------------|
| CLEAR | AB AFLAME AMBER ANTIQUÉ GOLD SILVER | ALEXANDRITE AMETHYST AQUAMARINE EMERALD JET RODALIN RUBY SAPPHIRE SMOKE TOPAZ | AB AFLAME AMBER ANTIQUÉ GOLD SILVER | |
| | BB BW OG OS VL VM | | BB BW OG OS VL VM | |
| EURO piece | EURO piece | EURO piece | EURO piece | pieces |

ROSETTES

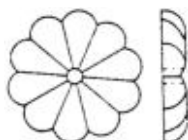

C.0202 lb

| | | | |
|-----------------|--------|--|-----|
| 40 mm CH: 4,0mm | 1,6462 | | 160 |
| 45 mm CH: 4,0mm | 1,9690 | | 60 |
| 50 mm CH: 4,0mm | 2,2515 | | 60 |
| 60 mm CH: 4,0mm | 4,5512 | | 40 |
| 70 mm CH: 4,0mm | 7,2949 | | 20 |

| CRYSTAL | CRYSTAL coated | COLOR | COLOR coated | minimum quantity |
|---------------|--|--|--|---------------------|
| CLEAR | AB AFLAME AMBER ANTIQUÉ GOLD SILVER | ALEXANDRITE AMETHYST AQUAMARINE EMERALD JET RODALIN RUBY SAPPHIRE SMOKE TOPAZ | AB AFLAME AMBER ANTIQUÉ GOLD SILVER | |
| | BB BW OG OS VL VM | | BB BW OG OS VL VM | |
| EURO piece | EURO piece | EURO piece | EURO piece | pieces |

STARS

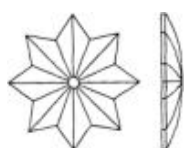

C.0236 lb

| | | | |
|-----------------|--------|---------|-----|
| 25 mm CH: 4,0mm | 1,9693 | 2,4617 | 250 |
| 30 mm CH: 4,0mm | 2,2312 | 2,7890 | 250 |
| 35 mm CH: 4,0mm | 2,6756 | 3,3445 | 100 |
| 40 mm CH: 4,0mm | 3,4838 | 4,3548 | 100 |
| 45 mm CH: 4,0mm | 4,6925 | 5,8655 | 100 |
| 50 mm CH: 5,0mm | 5,5714 | 6,9644 | 100 |
| 63 mm CH: 5,0mm | 8,6874 | 10,8593 | 50 |



C.0240 lb

| | | | |
|-------|--------|--------|-----|
| 30 mm | 2,2312 | 2,7890 | 250 |
|-------|--------|--------|-----|

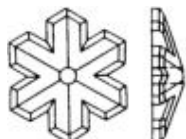

C.0294 lb

| | | | |
|-----------------|--------|--------|-----|
| 30 mm CH: 4,0mm | 2,3662 | 2,9578 | 100 |
|-----------------|--------|--------|-----|

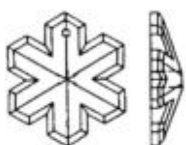

C.0302 lb

| | | | |
|-------|--------|--------|-----|
| 35 mm | 2,3662 | 2,9578 | 100 |
|-------|--------|--------|-----|

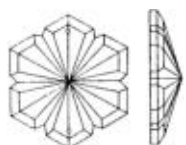

C.0317 lb

| | | | |
|-------|--------|--------|-----|
| 30 mm | 2,5986 | 3,2482 | 100 |
| 50 mm | 7,3575 | 9,1969 | 50 |

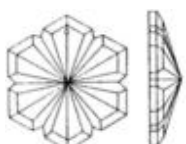

C.0329 lb

| | | | |
|-------|--------|--------|-----|
| 30 mm | 2,5986 | 3,2482 | 100 |
| 50 mm | 7,3575 | 9,1969 | 50 |

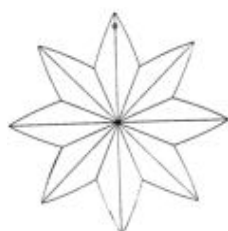

C.0533 lb

| | | | |
|--------|---------|----------|----|
| 115 mm | 86,6006 | 108,2509 | 25 |
|--------|---------|----------|----|

| CRYSTAL | CRYSTAL <u>coated</u> | C O L O R | C O L O R <u>coated</u> | minimum quantity |
|---------------|--|--|--|---------------------|
| CLEAR | AB AFLAME AMBER ANTIQUÉ GOLD SILVER | ALEXANDRITE AMETHYST AQUAMARINE EMERALD JET ROBALIN RUBY SAPPHIRE SMOKE TOPAZ | AB AFLAME AMBER ANTIQUÉ GOLD SILVER | |
| EURO piece | BB BW OG OS VL VM EURO piece | EURO piece | BB BW OG OS VL VM EURO piece | pieces |

CLAMP STONES



C.0394 la

55x35 mm

17,4756

21,8445

25

suitable clamp:



C.9042

BRASS
CHROME-PLATED
GOLD-PLATED

2,5625

3,1386

3,8210

50

50

50

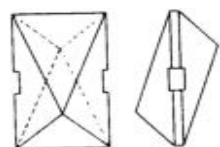

C.0402 la

50x28 mm

13,8047

17,2558

25

suitable clamp:



C.9041

BRASS
CHROME-PLATED
GOLD-PLATED

2,5625

3,1386

3,8210

50

50

50

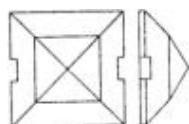

C.0413 la

45x45 mm

13,5876

16,9844

25

suitable clamp:



C.9043

BRASS
CHROME-PLATED
GOLD-PLATED

2,5625

3,1386

3,8210

50

50

50

| CRYSTAL | CRYSTAL coated | COLOR | COLOR coated | minimum quantity |
|---------------|--|--|--|---------------------|
| CLEAR | AB AFLAME AMBER ANTIQUÉ GOLD SILVER | ALEXANDRITE AMETHYST AQUAMARINE EMERALD JET ROSALIN RUBY SAPPHIRE SMOKE TOPAZ | AB AFLAME AMBER ANTIQUÉ GOLD SILVER | |
| EURO piece | BB BW OG OS VL VM EURO piece | EURO piece | BB BW OG OS VL VM EURO piece | pieces |

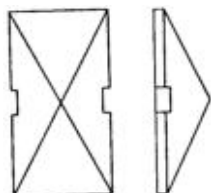

C.0463 la
60x30 mm

8,1716

10,2147

25

suitable clamp:



C.9041
BRASS
CHROME-PLATED
GOLD-PLATED

2,5625

3,1386

3,8210

50

50

50

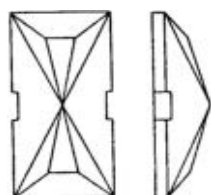

C.0464 la
60x30 mm

8,8322

11,0402

25

suitable clamp:



C.09041
BRASS
CHROME-PLATED
GOLD-PLATED

2,5625

3,1386

3,8210

50

50

50

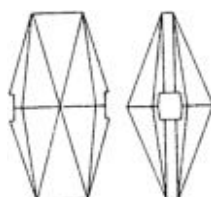

C.0475 la
55x30 mm

17,4756

21,8445

25

suitable clamp:



C.9042
BRASS
CHROME-PLATED
GOLD-PLATED

2,5625

3,1386

3,8210

50

50

50

| CRYSTAL | CRYSTAL <u>coated</u> | C O L O R | C O L O R <u>coated</u> | minimum quantity |
|---------------|--|--|--|---------------------|
| CLEAR | AB AFLAME AMBER ANTIQUÉ GOLD SILVER | ALEXANDRITE AMETHYST AQUAMARINE EMERALD JET ROBALIN RUBY SAPPHIRE SMOKE TOPAZ | AB AFLAME AMBER ANTIQUÉ GOLD SILVER | |
| | BB BW OG OS VL VM | | BB BW OG OS VL VM | |
| EURO piece | EURO piece | EURO piece | EURO piece | pieces |

BEADS



C.0197 la

| | | | |
|---------------|--------|--------|-----|
| 26 mm CH: 5mm | 4,8589 | 6,0738 | 150 |
|---------------|--------|--------|-----|



C.0199 lb

| | | | |
|---------------|--------|--------|-----|
| 16 mm CH: 2mm | 2,0824 | 2,6032 | 150 |
| 18 mm CH: 2mm | 2,8574 | 3,5720 | 150 |
| 20 mm CH: 2mm | 2,9572 | 3,6965 | 150 |
| 22 mm CH: 2mm | 3,8007 | 4,7510 | 150 |
| 24 mm CH: 2mm | 3,9879 | 4,9849 | 150 |
| 26 mm CH: 2mm | 4,4173 | 5,5216 | 150 |
| 28 mm CH: 2mm | 4,5644 | 5,7055 | 150 |



C.0198 lb

| | | | |
|---------------|--------|--------|-----|
| 20 mm CH: 3mm | 5,7198 | 7,1499 | 150 |
| 25 mm CH: 3mm | 7,5262 | 9,4077 | 150 |

| CRYSTAL | CRYSTAL <u>coated</u> | C O L O R | C O L O R <u>coated</u> | minimum quantity |
|---------------|--|--|--|---------------------|
| CLEAR | AB AFLAME AMBER ANTIQUÉ GOLD SILVER | ALEXANDRITE AMETHYST AQUAMARINE EMERALD JET ROBALIN RUBY SAPPHIRE SMOKE TOPAZ | AB AFLAME AMBER ANTIQUÉ GOLD SILVER | |
| | BB BW OG OS VL VM | | BB BW OG OS VL VM | |
| EURO piece | EURO piece | EURO piece | EURO piece | pieces |

CENTERPIECES



C.0196 la

| | | | |
|---------------|---------|---------|----|
| 25 mm CH: 3mm | 18,2292 | 22,7863 | 25 |
| 30 mm CH: 3mm | 19,1884 | 23,9857 | 25 |
| 35 mm CH: 3mm | 20,2027 | 25,2536 | 25 |

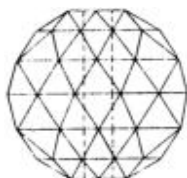

C.0328 la

| | | | |
|----------------|---------|---------|----|
| 50 mm CH: 12mm | 32,8157 | 41,0197 | 12 |
|----------------|---------|---------|----|

| CRYSTAL | CRYSTAL <u>coated</u> | C O L O R | C O L O R <u>coated</u> | minimum quantity |
|---------------|--|--|--|---------------------|
| CLEAR | AB AFLAME AMBER ANTIQUÉ GOLD SILVER | ALEXANDRITE AMETHYST AQUAMARINE EMERALD JET ROSALIN RUBY SAPPHIRE SMOKE TOPAZ | AB AFLAME AMBER ANTIQUÉ GOLD SILVER | |
| | BB BW OG OS VL VM | | BB BW OG OS VL VM | |
| EURO piece | EURO piece | EURO piece | EURO piece | pieces |

BOBECHES

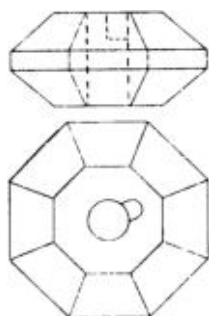

C.0298 Ia

| | | | |
|---------------------------------|---------|---------|----|
| 62x30 mm CH:13mm | 29,2369 | 36,5460 | 25 |
| <u>drilling of extra SH :</u> | 0,3800 | 0,3800 | |
| <u>stud-insertion into SH :</u> | | | |
| BRASS | 0,0900 | 0,0900 | |
| CHROME-PLATED | 0,1000 | 0,1000 | |
| GOLD-PLATED | 0,1200 | 0,1200 | |

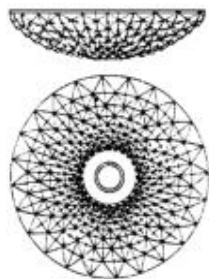

C.0299 Ib

| | | | |
|---------------------------------|---------|---------|-----|
| 25x7 mm CH:5mm | 1,9056 | 2,3819 | 100 |
| 60x15 mm CH:10mm | 10,5565 | 13,1955 | 50 |
| 80x18 mm CH:10mm | 24,6878 | 30,8596 | 25 |
| <u>drilling of extra SH :</u> | 0,3800 | 0,3800 | |
| <u>stud-insertion into SH :</u> | | | |
| BRASS | 0,0900 | 0,0900 | |
| CHROME-PLATED | 0,1000 | 0,1000 | |
| GOLD-PLATED | 0,1200 | 0,1200 | |



ECONOMIC



ECONOMIC

chandelier crystal

slight brilliance

machine-pressed

standard shapes

pinning service available

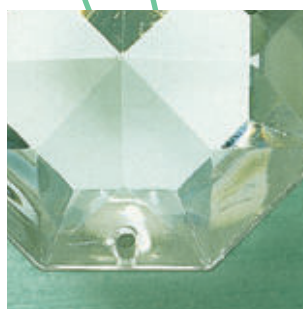

Schöler & Co. GmbH

Gablonzer Strasse 54-61
A-4550 Kremsmünster
Austria

T: ++43-75 83-77 23

F: ++43-75 83-78 12

E: office@scholer-crystal.at

W: www.scholer-crystal.at













ARTICLE INDEX

| Article: | Page: |
|-----------------|--------------|
| E.5001 | 12 |
| E.5002 | 12 |
| E.5100 | 7 |
| E.5101 | 7 |
| E.5103 | 7 |
| E.5104 | 7 |
| E.5200 | 8 |
| E.5202 | 8 |
| E.5204 | 8 |
| E.5220 | 8 |
| E.5230 | 8 |
| E.5234 | 8 |
| E.5250 | 7 |
| E.5310 | 12 |
| E.5450 | 9 |
| E.5451 | 12 |
| E.5500 | 9 |
| E.5525 | 9 |
| E.5550 | 9 |
| E.5600 | 10 |
| E.5601 | 12 |
| E.5603 | 12 |
| E.5650 | 10 |
| E.5675 | 10 |
| E.5680 | 10 |
| E.5700 | 11 |
| E.5710 | 11 |
| E.5720 | 11 |
| E.5730 | 11 |
| E.5810 | 13 |
| E.5820 | 13 |
| E.5830 | 13 |

PRODUCT GROUP

Page:

| | | |
|---|---|---------|
| OCTAGONS |  | 7 + 12 |
| SQUARE STONES |  | 7 |
| OVALS |  | 8 |
| ROSETTES |  | 8 |
| BALLS |  | 12 |
| ICICLES |  | 9 + 12 |
| COFFIN STONES & POINTED STONES & RECTANGLE STONES |  | 9 |
| ALMONDS |  | 10 + 12 |
| PENDELOQUES |  | 11 |
| BOBECHES |  | 13 |

| CRYSTAL CLEAR | CRYSTAL coated | minimum quantity | |
|----------------------|--|---------------------|------------------|
| | AB AFLAME AMBER ANTIQUE GOLD SILVER | | |
| EURO piece | EURO piece | CARTON pieces | CARTON pieces |

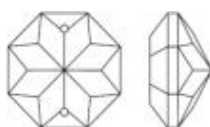

E.5100

| | | | | |
|-------|--------|--------|-------|--------|
| 12 mm | 0,0385 | 0,1427 | 2.000 | 24.000 |
| 14 mm | 0,0372 | 0,1414 | 2.000 | 24.000 |
| 16 mm | 0,0560 | 0,1778 | 1.000 | 12.000 |
| 18 mm | 0,0724 | 0,2275 | 1.000 | 12.000 |
| 20 mm | 0,0987 | 0,2934 | 500 | 6.000 |
| 22 mm | 0,1178 | 0,3351 | 400 | 4.800 |
| 24 mm | 0,1577 | 0,4136 | 400 | 4.800 |
| 26 mm | 0,1899 | 0,4963 | 200 | 2.400 |
| 28 mm | 0,2402 | 0,5972 | 200 | 2.400 |
| 30 mm | 0,2938 | 0,6937 | 200 | 2.400 |
| 32 mm | 0,4585 | 0,8920 | 200 | 2.400 |
| 34 mm | 0,5633 | 1,0279 | 100 | 1.200 |
| 36 mm | 1,1172 | 1,6378 | 256 | 768 |
| 38 mm | 1,2349 | 1,8467 | 216 | 648 |
| 40 mm | 1,3588 | 2,0444 | 216 | 648 |

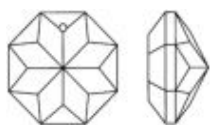

E.5101

| | | | | |
|-------|--------|--------|-------|--------|
| 14 mm | 0,0372 | 0,1414 | 2.000 | 24.000 |
| 16 mm | 0,0560 | 0,1778 | 1.000 | 12.000 |

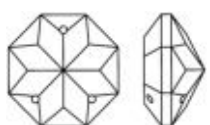

E.5103

| | | | | |
|-------|--------|--------|-----|-------|
| 22 mm | 0,1634 | 0,3807 | 400 | 4.800 |
|-------|--------|--------|-----|-------|

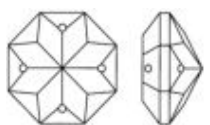

E.5104

| | | | | |
|-------|--------|--------|-------|--------|
| 18 mm | 0,1029 | 0,2580 | 1.000 | 12.000 |
|-------|--------|--------|-------|--------|

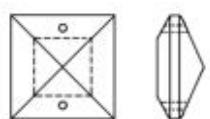

E.5250

| | | | | |
|-------|--------|--------|-----|-------|
| 18 mm | 0,1384 | 0,3090 | 500 | 6.000 |
| 20 mm | 0,1874 | 0,3975 | 500 | 6.000 |
| 22 mm | 0,2310 | 0,4653 | 400 | 4.800 |
| 24 mm | 0,3021 | 0,5780 | 200 | 2.400 |
| 26 mm | 0,3718 | 0,7027 | 200 | 2.400 |

| CRYSTAL | CRYSTAL coated | minimum quantity | |
|---------------|--|---------------------|------------------|
| CLEAR | AB AFLAME AMBER ANTIQUE GOLD SILVER | | |
| | BB BW OG OS VL VM | | |
| EURO piece | EURO piece | BOX pieces | CARTON pieces |

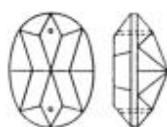

E.5234

| | | | | |
|-------|--------|--------|-------|--------|
| 12 mm | 0,2076 | 0,3117 | 3.000 | 36.000 |
| 14 mm | 0,2294 | 0,3336 | 2.500 | 30.000 |
| 16 mm | 0,2758 | 0,3976 | 2.000 | 24.000 |
| 18 mm | 0,2833 | 0,4384 | 1.000 | 12.000 |
| 20 mm | 0,4123 | 0,6072 | 900 | 10.800 |



E.5230

| | | | | |
|-------|--------|--------|-----|-------|
| 34 mm | 0,2891 | 0,6775 | 500 | 6.000 |
|-------|--------|--------|-----|-------|



E.5200

| | | | | |
|-----------------|--------|--------|-------|--------|
| 15 mm CH: 2,3mm | 0,0854 | 0,2524 | 2.000 | 24.000 |
| 20 mm CH: 3,1mm | 0,0830 | 0,2922 | 1.000 | 12.000 |
| 25 mm CH: 3,1mm | 0,1198 | 0,4294 | 500 | 6.000 |
| 30 mm CH: 3,1mm | 0,2434 | 0,6553 | 400 | 4.800 |
| 50 mm CH: 4,0mm | 1,0459 | 2,1941 | 600 | 7.200 |

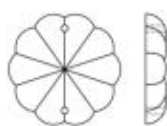

E.5202

| | | | | |
|-------|--------|--------|-------|--------|
| 15 mm | 0,0963 | 0,2634 | 2.000 | 24.000 |
|-------|--------|--------|-------|--------|

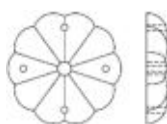

E.5204

| | | | | |
|-----------------|--------|--------|-----|-------|
| 30 mm CH: 5,0mm | 0,3373 | 0,8663 | 400 | 4.800 |
|-----------------|--------|--------|-----|-------|

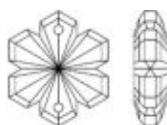

E.5220

| | | | | |
|-------|--------|--------|-------|--------|
| 16 mm | 0,0538 | 0,1601 | 1.000 | 12.000 |
|-------|--------|--------|-------|--------|

| CRYSTAL CLEAR | CRYSTAL coated | minimum quantity | |
|----------------------|--|---------------------|------------------|
| | AB AFLAME AMBER ANTIQUÉ GOLD SILVER | | |
| EURO piece | EURO piece | BOX pieces | CARTON pieces |



E.5450

| | | | | |
|-----------|--------|--------|-----|-------|
| 63x12 mm | 0,3456 | 0,7151 | 612 | 1.836 |
| 76x14 mm | 0,3920 | 1,0406 | 561 | 1.683 |
| 100x16 mm | 1,0740 | 1,9208 | 300 | 900 |



E.5500

| | | | | |
|-------------|--------|--------|-----|-------|
| 58x24x18 mm | 0,4720 | 1,4157 | 480 | 1.440 |
| 63x28x22 mm | 0,5344 | 1,6084 | 390 | 1.170 |



E.5525

| | | | | |
|-----------|--------|--------|-----|-------|
| 76x20 mm | 0,9395 | 1,8209 | 462 | 1.386 |
| 100x20 mm | 1,8960 | 2,8770 | 392 | 1.176 |

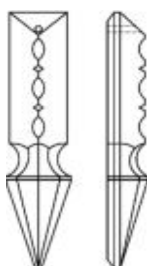

E.5550

| | | | | |
|-----------|--------|--------|-----|-------|
| 50x14 mm | 0,3235 | 0,9055 | 840 | 2.520 |
| 63x15 mm | 0,4055 | 1,4795 | 510 | 1.530 |
| 76x16 mm | 0,5519 | 1,7288 | 363 | 1.089 |
| 100x18 mm | 1,3139 | 3,3303 | 280 | 840 |

| CRYSTAL | CRYSTAL coated | minimum quantity | |
|---------------|--|---------------------|------------------|
| CLEAR | AB AFLAME AMBER ANTIQUE GOLD SILVER | | |
| | BB BW OG OS VL VM | | |
| EURO piece | EURO piece | BOX pieces | CARTON pieces |



E.5600

38x24 mm
50x32 mm
63x40 mm
76x48 mm

0,1951
0,3884
0,8490
1,7376

0,5834
1,1717
1,8798
3,2159

400 4.800
350 1.050
225 675
128 384



E.5650

32x20 mm
38x24 mm
50x32 mm
63x40 mm
76x48 mm

0,1466
0,1989
0,3884
0,8308
1,7762

0,5350
0,5874
1,1717
1,8616
3,2546

600 7.200
400 4.800
385 1.155
225 675
128 384



E.5675

38x22 mm
50x29 mm
63x37 mm
76x46 mm

0,1951
0,3884
0,8127
1,5178

0,5834
1,1717
1,8435
2,9961

400 4.800
385 1.155
225 675
128 384



E.5680

38x19 mm
50x25 mm

0,1951
0,3884

0,5835
1,1717

600 7.200
300 3.600

| CRYSTAL CLEAR | CRYSTAL coated | minimum quantity | | |
|----------------------|--|---------------------|------------------|--|
| | AB AFLAME AMBER ANTIQUE GOLD SILVER | | | |
| EURO piece | EURO piece | BOX pieces | CARTON pieces | |

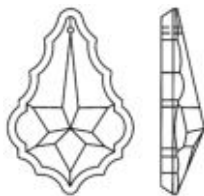

E.5700

50x34 mm
63x43 mm

0,4712
0,8469

1,2545
1,5920

504
250

1.512
750

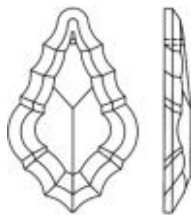

E.5710

38x24 mm
50x32 mm
63x40 mm
76x49 mm

0,2310
0,4328
0,7505
1,1805

0,6276
1,2162
1,7993
2,8443

1.536
756
350
208

4.608
2.268
1.050
624

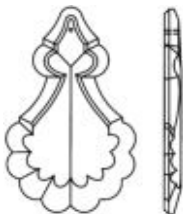

E.5720

50x32 mm
63x40 mm
76x49 mm

0,4328
0,7571
1,2229

1,2162
1,8058
2,8867

756
375
208

2.268
1.125
624

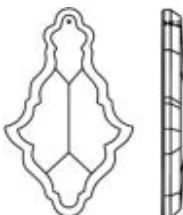

E.5730

100x61 mm

3,7143

8,3899

144

432

| CRYSTAL | CRYSTAL coated | minimum quantity | |
|---------------|--|---------------------|------------------|
| CLEAR | AB AFLAME AMBER ANTIQUE GOLD SILVER | | |
| | BB BW OG OS VL VM | | |
| EURO piece | EURO piece | BOX pieces | CARTON pieces |



E.5002

| | | | | |
|-------|--------|--------|-------|--------|
| 10 mm | 0,0453 | 0,1789 | 3.300 | 39.600 |
| 12 mm | 0,0479 | 0,1815 | 2.200 | 26.400 |
| 14 mm | 0,0310 | 0,1651 | 1.800 | 21.600 |
| 16 mm | 0,0631 | 0,2193 | 900 | 10.800 |
| 18 mm | 0,0879 | 0,2870 | 640 | 7.680 |
| 20 mm | 0,1670 | 0,4171 | 420 | 5.040 |
| 22 mm | 0,1880 | 0,4669 | 300 | 3.600 |
| 24 mm | 0,2364 | 0,5648 | 240 | 2.880 |
| 26 mm | 0,2621 | 0,6551 | 200 | 2.400 |
| 28 mm | 0,3191 | 0,7768 | 150 | 1.800 |
| 30 mm | 0,3561 | 0,8694 | 125 | 1.500 |
| 32 mm | 0,6495 | 1,2060 | 100 | 1.200 |
| 34 mm | 0,7549 | 1,3681 | 80 | 960 |
| 36 mm | 0,8632 | 1,5312 | 80 | 960 |
| 38 mm | 1,0341 | 1,7964 | 80 | 960 |
| 40 mm | 1,0683 | 1,9354 | 80 | 960 |

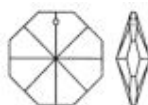

E.5001

| | | | | |
|-------|--------|--------|-------|--------|
| 14 mm | 0,0310 | 0,1651 | 1.800 | 21.600 |
|-------|--------|--------|-------|--------|



E.5310

| | | | | |
|-------|--------|--------|-----|-------|
| 20 mm | 0,4263 | 0,8338 | 144 | 1.728 |
| 30 mm | 0,5344 | 1,2133 | 48 | 576 |
| 40 mm | 0,9135 | 1,7417 | 40 | 480 |
| 50 mm | 2,4294 | 3,7479 | 12 | 144 |



E.5451

| | | | | |
|----------|--------|--------|-----|-------|
| 38x11 mm | 0,3358 | 0,5891 | 288 | 3.456 |
| 50x12 mm | 0,4225 | 0,8153 | 216 | 2.592 |
| 63x13 mm | 0,4870 | 0,9611 | 192 | 2.304 |
| 76x14 mm | 0,6891 | 1,5485 | 80 | 960 |

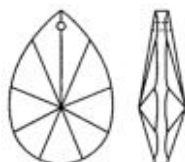

E.5603

| | | | | |
|----------|--------|--------|-----|-------|
| 38x22 mm | 0,3387 | 0,8646 | 192 | 2.304 |
| 50x29 mm | 0,4030 | 1,4080 | 90 | 1.080 |
| 63x37 mm | 0,6657 | 1,9988 | 45 | 540 |
| 76x44 mm | 1,2351 | 3,1319 | 24 | 288 |

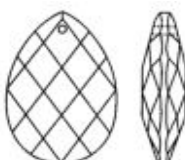

E.5601

| | | | | |
|----------|--------|--------|-----|-------|
| 38x24 mm | 0,3387 | 0,8646 | 192 | 2.304 |
| 50x32 mm | 0,4030 | 1,4080 | 90 | 1.080 |
| 63x40 mm | 0,6657 | 1,9988 | 45 | 540 |
| 76x48 mm | 1,2351 | 3,1319 | 24 | 288 |

| | |
|-------------------|----------------------|
| CRYSTAL | minimum quantity |
| CLEAR | |
| EURO piece | CARTON pieces |



E.5810

center hole: 24 mm

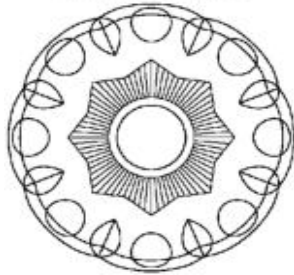

100x28 mm
100x28 mm - 4 SH

| | |
|--------|-----|
| 1,3178 | 108 |
| 1,7132 | 108 |

drilling of extra SH:

| |
|--------|
| 0,3800 |
|--------|

stud insertion into SH:

BRASS
CHROME-PLATED
GOLD-PLATED

| |
|--------|
| 0,0900 |
| 0,1000 |
| 0,1200 |

drilling of bigger CH:

| |
|--------|
| 1,2500 |
|--------|



E.5820

center hole: 24 mm



100x30 mm
100x30 mm - 5 SH

| | |
|--------|-----|
| 1,3178 | 108 |
| 1,7132 | 108 |

drilling of extra SH:

| |
|--------|
| 0,3800 |
|--------|

stud insertion into SH:

BRASS
CHROME-PLATED
GOLD-PLATED

| |
|--------|
| 0,0900 |
| 0,1000 |
| 0,1200 |

drilling of bigger CH:

| |
|--------|
| 1,2500 |
|--------|



E.5830

center hole: 24 mm

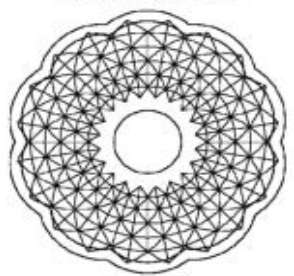

100x30 mm
100x30 mm - 5 SH

| | |
|--------|-----|
| 1,3178 | 108 |
| 1,7132 | 108 |

drilling of extra SH:

| |
|--------|
| 0,3800 |
|--------|

stud insertion into SH:

BRASS
CHROME-PLATED
GOLD-PLATED

| |
|--------|
| 0,0900 |
| 0,1000 |
| 0,1200 |

drilling of bigger CH:

| |
|--------|
| 1,2500 |
|--------|



BASIC



BASIC

chandelier crystal

excellent brilliance

hand/machine-cut

popular shapes

pinning service available



Schöler & Co. GmbH

Gablonzer Strasse 54-61
A-4550 Kremsmünster
Austria

T: ++43-75 83-77 23

F: ++43-75 83-78 12

E: office@scholer-crystal.at

W: www.scholer-crystal.at

















ARTICLE INDEX

| <u>Article:</u> | <u>Page:</u> | <u>Article:</u> | <u>Page:</u> | <u>Article:</u> | <u>Page:</u> |
|-----------------|--------------|-----------------|--------------|-----------------|--------------|
| B.4003 | 24 | B.4205 | 21 | B.4541 | 20 |
| B.4004 | 24 | B.4208 | 26 | B.4549 | 21 |
| B.4005 | 18 | B.4211 | 26 | B.4580 | 19 |
| B.4006 | 18 | B.4214 | 22 | B.4581 | 19 |
| B.4007 | 18 | B.4215 | 22 | B.4700 | 33 |
| B.4009 | 18 | B.4216 | 15 | B.4702 | 33 |
| B.4010 | 18 | B.4222 | 14 | B.4705 | 32 |
| B.4011 | 18 | B.4230 | 15 | B.4710 | 32 |
| B.4012 | 24 | B.4236 | 15 | B.4715 | 33 |
| B.4014 | 14 | B.4240 | 9 | B.4717 | 33 |
| B.4015 | 14 | B.4241 | 9 | B.4730 | 32 |
| B.4016 | 15 | B.4243 | 11 | B.4731 | 11 |
| B.4020 | 19 | B.4246 | 11 | B.4732 | 11 |
| B.4021 | 19 | B.4250 | 13 | B.4740 | 32 |
| B.4022 | 14 | B.4251 | 13 | B.4750 | 32 |
| B.4023 | 14 | B.4253 | 13 | B.4800 | 35 |
| B.4030 | 23 | B.4254 | 13 | B.4805 | 35 |
| B.4031 | 17 | B.4310 | 23 | B.4810 | 35 |
| B.4032 | 23 | B.4320 | 23 | B.4820 | 35 |
| B.4035 | 23 | B.4322 | 14 | B.4830 | 35 |
| B.4037 | 21 | B.4327 | 8 | B.4900 | 34 |
| B.4038 | 21 | B.4328 | 8 | B.4910 | 34 |
| B.4039 | 21 | B.4335 | 20 | B.4920 | 34 |
| B.4040 | 24 | B.4337 | 8 | B.4930 | 34 |
| B.4108 | 26 | B.4338 | 8 | B.4935 | 34 |
| B.4109 | 26 | B.4340 | 20 | B.4940 | 34 |
| B.4110 | 26 | B.4341 | 10 | | |
| B.4111 | 26 | B.4342 | 10 | | |
| B.4112 | 22 | B.4343 | 10 | | |
| B.4113 | 21 | B.4344 | 10 | | |
| B.4114 | 22 | B.4345 | 10 | | |
| B.4115 | 22 | B.4346 | 10 | | |
| B.4116 | 24 | B.4347 | 7 | | |
| B.4117 | 22 | B.4348 | 7 | | |
| B.4118 | 16 | B.4350 | 12 | | |
| B.4119 | 16 | B.4351 | 12 | | |
| B.4120 | 17 | B.4353 | 12 | | |
| B.4121 | 17 | B.4354 | 12 | | |
| B.4122 | 24 | B.4357 | 7 | | |
| B.4124 | 16 | B.4358 | 7 | | |
| B.4125 | 25 | B.4400 | 28 | | |
| B.4126 | 25 | B.4405 | 28 | | |
| B.4127 | 25 | B.4410 | 28 | | |
| B.4128 | 16 | B.4420 | 28 | | |
| B.4129 | 16 | B.4425 | 30 | | |
| B.4130 | 15 | B.4430 | 30 | | |
| B.4131 | 17 | B.4433 | 29 | | |
| B.4132 | 19 | B.4434 | 30 | | |
| B.4133 | 20 | B.4435 | 30 | | |
| B.4134 | 20 | B.4440 | 29 | | |
| B.4135 | 19 | B.4444 | 29 | | |
| B.4136 | 15 | B.4445 | 29 | | |
| B.4137 | 17 | B.4450 | 31 | | |
| B.4138 | 25 | B.4460 | 31 | | |
| B.4139 | 25 | B.4463 | 27 | | |
| B.4140 | 9 | B.4464 | 27 | | |
| B.4141 | 9 | B.4465 | 27 | | |
| B.4143 | 11 | B.4470 | 27 | | |
| B.4146 | 11 | B.4480 | 31 | | |
| B.4149 | 25 | | | | |

PRODUCT GROUP

Page:

| | | |
|---------------------------------|---|---------|
| OCTAGONS |  | 7 |
| ROUNDS & OVALS & SPECIAL STONES |  | 8 - 10 |
| SQUARE STONES |  | 11 - 13 |
| BALLS & FINIALS |  | 14 |
| ICICLES |  | 15 |
| PRISMS |  | 16 - 17 |
| COFFIN STONES |  | 18 |
| RECTANGLE STONES |  | 19 |
| POINTED STONES |  | 20 |
| PRISMS (CELESTIAL & NATURAL) |  | 21 - 22 |
| ALMONDS |  | 23 - 25 |
| PENDELOQUES |  | 26 - 31 |
| ROSSETTES & STARS |  | 32 - 33 |
| CENTERPIECES |  | 34 |
| BOBECHES |  | 35 |

| CRYSTAL | CRYSTAL <u>coated</u> | COLOR | COLOR <u>coated</u> | minimum quantity | |
|---------------|--|--|--|---------------------|------------------|
| CLEAR | AB AFLAME AMBER ANTIQUÉ GOLD SILVER | ALEXANDRITE AMETHYST AQUAMARINE EMERALD JET ROSALIN RUBY SAPPHIRE SMOKE TOPAZ | AB AFLAME AMBER ANTIQUÉ GOLD SILVER | | |
| | BB BW OG OS VL VM | | BB BW OG OS VL VM | | |
| EURO piece | EURO piece | EURO piece | EURO piece | BOX pieces | CARTON pieces |

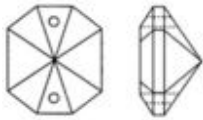

B.4357

18x14 mm
22x17 mm
26x20 mm
30x23 mm
34x26 mm
38x29 mm
42x32 mm

| | | | | | |
|--------|--------|--------|--------|-----|-------|
| 0,3699 | 0,5339 | 0,8138 | 0,9778 | 336 | 4.032 |
| 0,4600 | 0,6798 | 1,0120 | 1,2318 | 288 | 3.456 |
| 0,6369 | 0,9259 | 1,4011 | 1,6902 | 162 | 1.944 |
| 0,9201 | 1,3230 | 2,0241 | 2,4271 | 135 | 1.620 |
| 1,3271 | 1,7788 | 2,9196 | 3,3713 | 100 | 1.200 |
| 1,5319 | 1,9946 | 3,3702 | 3,8329 | 80 | 960 |
| 2,1447 | 3,0299 | 4,7183 | 5,6035 | 48 | 576 |

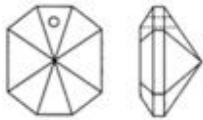

B.4358

18x14 mm
22x17 mm
26x20 mm
30x23 mm
34x26 mm
38x29 mm
42x32 mm

| | | | | | |
|--------|--------|--------|--------|-----|-------|
| 0,3699 | 0,5339 | 0,8138 | 0,9778 | 336 | 4.032 |
| 0,4600 | 0,6798 | 1,0120 | 1,2318 | 288 | 3.456 |
| 0,6369 | 0,9259 | 1,4011 | 1,6902 | 162 | 1.944 |
| 0,9201 | 1,3230 | 2,0241 | 2,4271 | 135 | 1.620 |
| 1,3271 | 1,7788 | 2,9196 | 3,3713 | 100 | 1.200 |
| 1,5319 | 1,9946 | 3,3702 | 3,8329 | 80 | 960 |
| 2,1447 | 3,0299 | 4,7183 | 5,6035 | 48 | 576 |

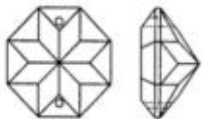

B.4347

18 mm
20 mm
22 mm
24 mm
26 mm
28 mm
30 mm
32 mm
34 mm
36 mm
38 mm
40 mm
50 mm
60 mm

| | | | | | |
|--------|--------|--------|--------|-----|-------|
| 0,5081 | 0,6832 | 1,1180 | 1,2930 | 384 | 4.608 |
| 0,5620 | 0,7817 | 1,2364 | 1,4562 | 336 | 4.032 |
| 0,6392 | 0,8844 | 1,4062 | 1,6514 | 288 | 3.456 |
| 0,7262 | 1,0152 | 1,5976 | 1,8866 | 288 | 3.456 |
| 0,8259 | 1,1718 | 1,8169 | 2,1628 | 162 | 1.944 |
| 0,9514 | 1,3544 | 2,0929 | 2,4960 | 162 | 1.944 |
| 1,0592 | 1,5752 | 2,3304 | 2,8464 | 108 | 1.296 |
| 1,2684 | 1,7580 | 2,7905 | 3,2800 | 108 | 1.296 |
| 1,3680 | 1,8924 | 3,0094 | 3,5338 | 80 | 960 |
| 1,4490 | 2,0367 | 3,1878 | 3,7756 | 80 | 960 |
| 1,5477 | 2,2384 | 3,4048 | 4,0955 | 48 | 576 |
| 1,7150 | 2,5997 | 3,7730 | 4,6577 | 48 | 576 |
| 2,1184 | 3,3323 | 4,6604 | 5,8743 | 30 | 360 |
| 3,0011 | 4,7008 | 6,6023 | 8,3021 | 15 | 180 |

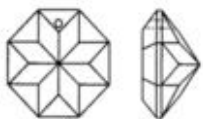

B.4348

18 mm
20 mm
22 mm
24 mm
26 mm
28 mm
30 mm
32 mm
34 mm
36 mm
38 mm
40 mm
50 mm
60 mm

| | | | | | |
|--------|--------|--------|--------|-----|-------|
| 0,5081 | 0,6832 | 1,1180 | 1,2930 | 384 | 4.608 |
| 0,5620 | 0,7817 | 1,2364 | 1,4562 | 336 | 4.032 |
| 0,6392 | 0,8844 | 1,4062 | 1,6514 | 288 | 3.456 |
| 0,7262 | 1,0152 | 1,5976 | 1,8866 | 288 | 3.456 |
| 0,8259 | 1,1718 | 1,8169 | 2,1628 | 162 | 1.944 |
| 0,9514 | 1,3544 | 2,0929 | 2,4960 | 162 | 1.944 |
| 1,0592 | 1,5752 | 2,3304 | 2,8464 | 108 | 1.296 |
| 1,2684 | 1,7580 | 2,7905 | 3,2800 | 108 | 1.296 |
| 1,3680 | 1,8924 | 3,0094 | 3,5338 | 80 | 960 |
| 1,4490 | 2,0367 | 3,1878 | 3,7756 | 80 | 960 |
| 1,5477 | 2,2384 | 3,4048 | 4,0955 | 48 | 576 |
| 1,7150 | 2,5997 | 3,7730 | 4,6577 | 48 | 576 |
| 2,1184 | 3,3323 | 4,6604 | 5,8743 | 30 | 360 |
| 3,0011 | 4,7008 | 6,6023 | 8,3021 | 15 | 180 |

| CRYSTAL | CRYSTAL <u>coated</u> | COLOR | COLOR <u>coated</u> | minimum quantity | |
|---------------|--|---|--|---------------------|------------------|
| CLEAR | AB AFLAME AMBER ANTIQUÉ GOLD SILVER | ALEXANDRITE AMETHYST AQUAMARINE EMERALD JET ROSA LIN RUBY SAPPHIRE SMOKE TOPAZ | AB AFLAME AMBER ANTIQUÉ GOLD SILVER | | |
| | BB BW OG OS VL VM | | BB BW OG OS VL VM | | |
| EURO piece | EURO piece | EURO piece | EURO piece | BOX pieces | CARTON pieces |

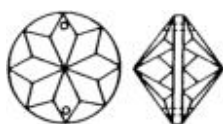

B.4327

| | | | | | |
|-------|--------|--------|--|-----|-------|
| 18 mm | 1,3074 | 1,7621 | | 400 | 4.800 |
| 20 mm | 1,4782 | 2,0491 | | 300 | 3.600 |
| 22 mm | 1,7940 | 2,4309 | | 250 | 3.000 |
| 24 mm | 2,1724 | 2,9232 | | 200 | 2.400 |
| 26 mm | 2,6065 | 3,5050 | | 160 | 1.920 |
| 28 mm | 3,1281 | 4,1749 | | 120 | 1.440 |

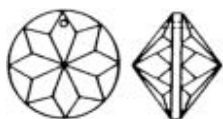

B.4328

| | | | | | |
|-------|--------|--------|--|-----|-------|
| 18 mm | 1,3074 | 1,7621 | | 400 | 4.800 |
| 20 mm | 1,4782 | 2,0491 | | 300 | 3.600 |
| 22 mm | 1,7940 | 2,4309 | | 250 | 3.000 |
| 24 mm | 2,1724 | 2,9232 | | 200 | 2.400 |
| 26 mm | 2,6065 | 3,5050 | | 160 | 1.920 |
| 28 mm | 3,1281 | 4,1749 | | 120 | 1.440 |

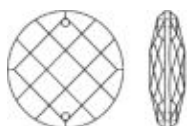

B.4337

| | | | | | |
|-------|--------|--------|--|-----|-------|
| 30 mm | 0,7102 | 1,4186 | | 180 | 2.160 |
|-------|--------|--------|--|-----|-------|

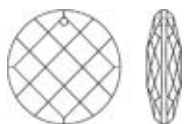

B.4338

| | | | | | |
|-------|--------|--------|--|-----|-------|
| 30 mm | 0,7102 | 1,4186 | | 180 | 2.160 |
|-------|--------|--------|--|-----|-------|

| CRYSTAL | CRYSTAL <u>coated</u> | COLOR | COLOR <u>coated</u> | minimum quantity | |
|---------------|--|---|--|---------------------|------------------|
| CLEAR | AB AFLAME AMBER ANTIQUÉ GOLD SILVER | ALEXANDRITE AMETHYST AQUAMARINE EMERALD JET ROSA LIN RUBY SAPPHIRE SMOKE TOPAZ | AB AFLAME AMBER ANTIQUÉ GOLD SILVER | | |
| | BB BW OG OS VL VM | | BB BW OG OS VL VM | | |
| EURO piece | EURO piece | EURO piece | EURO piece | BOX pieces | CARTON pieces |

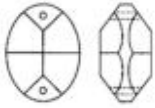

B.4140

| | | | | | | |
|-------|--------|--------|--------|--------|-------|--------|
| 18 mm | 0,2442 | 0,4193 | 0,5372 | 0,7123 | 1.100 | 13.200 |
| 20 mm | 0,2849 | 0,5049 | 0,5605 | 0,7806 | 1.000 | 12.000 |
| 22 mm | 0,3503 | 0,5958 | 0,7706 | 1,0161 | 432 | 5.184 |
| 24 mm | 0,4281 | 0,7172 | 0,9420 | 1,2310 | 384 | 4.608 |
| 26 mm | 0,5060 | 0,8519 | 1,1132 | 1,4591 | 384 | 4.608 |
| 28 mm | 0,5840 | 0,9868 | 1,2848 | 1,6876 | 336 | 4.032 |
| 30 mm | 0,7007 | 1,1524 | 1,5416 | 1,9933 | 189 | 2.268 |
| 32 mm | 0,8174 | 1,3070 | 1,7984 | 2,2880 | 162 | 1.944 |
| 40 mm | 1,2050 | 1,9674 | 2,6508 | 3,4132 | 100 | 1.200 |
| 50 mm | 1,4828 | 2,6957 | 3,2624 | 4,4752 | 60 | 720 |

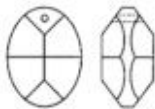

B.4141

| | | | | | | |
|-------|--------|--------|--------|--------|-------|--------|
| 18 mm | 0,2442 | 0,4193 | 0,5372 | 0,7123 | 1.100 | 13.200 |
| 20 mm | 0,2849 | 0,5049 | 0,5605 | 0,7806 | 1.000 | 12.000 |
| 22 mm | 0,3503 | 0,5958 | 0,7706 | 1,0161 | 432 | 5.184 |
| 24 mm | 0,4281 | 0,7172 | 0,9420 | 1,2310 | 384 | 4.608 |
| 26 mm | 0,5060 | 0,8519 | 1,1132 | 1,4591 | 384 | 4.608 |
| 28 mm | 0,5840 | 0,9868 | 1,2848 | 1,6876 | 336 | 4.032 |
| 30 mm | 0,7007 | 1,1524 | 1,5416 | 1,9933 | 189 | 2.268 |
| 32 mm | 0,8174 | 1,3070 | 1,7984 | 2,2880 | 162 | 1.944 |
| 40 mm | 1,2050 | 1,9674 | 2,6508 | 3,4132 | 100 | 1.200 |
| 50 mm | 1,4828 | 2,6957 | 3,2624 | 4,4752 | 60 | 720 |

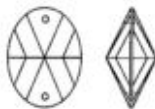

B.4240

| | | | | | | |
|-------|--------|--------|--------|--------|-------|--------|
| 18 mm | 0,3329 | 0,5081 | 0,7324 | 0,9076 | 1.000 | 12.000 |
| 20 mm | 0,3893 | 0,5946 | 0,8564 | 1,0617 | 800 | 9.600 |
| 22 mm | 0,4247 | 0,6701 | 0,9343 | 1,1797 | 384 | 4.608 |
| 24 mm | 0,4954 | 0,7844 | 1,0898 | 1,3788 | 384 | 4.608 |
| 26 mm | 0,5662 | 0,9121 | 1,2457 | 1,5916 | 384 | 4.608 |
| 28 mm | 0,6723 | 1,0748 | 1,4791 | 1,8816 | 216 | 2.592 |
| 30 mm | 0,7786 | 1,2304 | 1,7128 | 2,1646 | 162 | 1.944 |
| 32 mm | 0,8847 | 1,3701 | 1,9462 | 2,4317 | 135 | 1.620 |

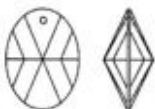

B.4241

| | | | | | | |
|-------|--------|--------|--------|--------|-------|--------|
| 18 mm | 0,3329 | 0,5081 | 0,7324 | 0,9076 | 1.000 | 12.000 |
| 20 mm | 0,3893 | 0,5946 | 0,8564 | 1,0617 | 800 | 9.600 |
| 22 mm | 0,4247 | 0,6701 | 0,9343 | 1,1797 | 384 | 4.608 |
| 24 mm | 0,4954 | 0,7844 | 1,0898 | 1,3788 | 384 | 4.608 |
| 26 mm | 0,5662 | 0,9121 | 1,2457 | 1,5916 | 384 | 4.608 |
| 28 mm | 0,6723 | 1,0748 | 1,4791 | 1,8816 | 216 | 2.592 |
| 30 mm | 0,7786 | 1,2304 | 1,7128 | 2,1646 | 162 | 1.944 |
| 32 mm | 0,8847 | 1,3701 | 1,9462 | 2,4317 | 135 | 1.620 |

| CRYSTAL | CRYSTAL coated | COLOR | COLOR coated | minimum quantity | |
|---------------|--|---|--|---------------------|------------------|
| CLEAR | AB AFLAME AMBER ANTIQUÉ GOLD SILVER | ALEXANDRITE AMETHYST AQUAMARINE EMERALD JET ROSA LIN RUBY SAPPHIRE SMOKE TOPAZ | AB AFLAME AMBER ANTIQUÉ GOLD SILVER | | |
| | BB BW OG OS VL VM | | BB BW OG OS VL VM | | |
| EURO piece | EURO piece | EURO piece | EURO piece | BOX pieces | CARTON pieces |

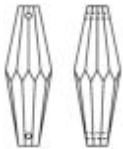

B.4342

28x10 mm
38x14 mm

0,8490
1,0150

1,0130
1,4774

1,8677
2,2331

2,0317
2,6955

360
180

4.320
2.160

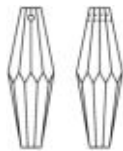

B.4341

28x10 mm
38x14 mm

0,8490
1,0150

1,0130
1,4774

1,8677
2,2331

2,0317
2,6955

360
180

4.320
2.160

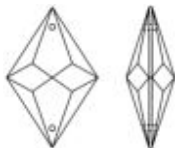

B.4344

28x18 mm
38x24 mm

0,8104
0,9689

1,1054
1,4319

1,7828
2,1317

2,0779
2,5947

240
162

2.880
1.944

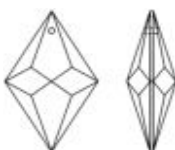

B.4343

28x18 mm
38x24 mm

0,8104
0,9689

1,1054
1,4319

1,7828
2,1317

2,0779
2,5947

240
162

2.880
1.944



B.4346

30 mm

0,7077

1,1800

1,5570

2,0293

162

1.944



B.4345

30 mm

0,7077

1,1800

1,5570

2,0293

162

1.944

| CRYSTAL | CRYSTAL coated | COLOR | COLOR coated | minimum quantity | |
|---------------|--|---|--|---------------------|------------------|
| CLEAR | AB AFLAME AMBER ANTIQUÉ GOLD SILVER | ALEXANDRITE AMETHYST AQUAMARINE EMERALD JET ROSA LIN RUBY SAPPHIRE SMOKE TOPAZ | AB AFLAME AMBER ANTIQUÉ GOLD SILVER | | |
| | BB BW OG OS VL VM | | BB BW OG OS VL VM | | |
| EURO piece | EURO piece | EURO piece | EURO piece | BOX pieces | CARTON pieces |

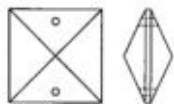

B.4143

| | | | | | | |
|-------|--------|--------|--------|--------|-----|--------|
| 14 mm | 0,0863 | 0,2174 | 0,2109 | 0,3420 | 900 | 10.800 |
| 16 mm | 0,1245 | 0,2754 | 0,3044 | 0,4553 | 700 | 8.400 |
| 18 mm | 0,1409 | 0,3334 | 0,3443 | 0,5369 | 384 | 4.608 |
| 20 mm | 0,1839 | 0,4214 | 0,4284 | 0,6658 | 336 | 4.032 |
| 22 mm | 0,2106 | 0,4751 | 0,5147 | 0,7793 | 336 | 4.032 |
| 24 mm | 0,2824 | 0,5939 | 0,6904 | 1,0018 | 189 | 2.268 |
| 26 mm | 0,3660 | 0,7398 | 0,8946 | 1,2684 | 162 | 1.944 |
| 28 mm | 0,4057 | 0,8407 | 0,9918 | 1,4268 | 162 | 1.944 |
| 30 mm | 0,5421 | 1,0301 | 1,3250 | 1,8130 | 135 | 1.620 |
| 40 mm | 1,1652 | 1,9887 | 2,5633 | 3,3868 | 48 | 576 |

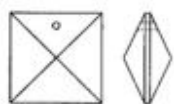

B.4146

| | | | | | | |
|-------|--------|--------|--------|--------|-----|--------|
| 14 mm | 0,0863 | 0,2174 | 0,2109 | 0,3420 | 900 | 10.800 |
| 16 mm | 0,1245 | 0,2754 | 0,3044 | 0,4553 | 700 | 8.400 |
| 18 mm | 0,1409 | 0,3334 | 0,3443 | 0,5369 | 384 | 4.608 |
| 20 mm | 0,1839 | 0,4214 | 0,4284 | 0,6658 | 336 | 4.032 |
| 22 mm | 0,2106 | 0,4751 | 0,5147 | 0,7793 | 336 | 4.032 |
| 24 mm | 0,2824 | 0,5939 | 0,6904 | 1,0018 | 189 | 2.268 |
| 26 mm | 0,3660 | 0,7398 | 0,8946 | 1,2684 | 162 | 1.944 |
| 28 mm | 0,4057 | 0,8407 | 0,9918 | 1,4268 | 162 | 1.944 |
| 30 mm | 0,5421 | 1,0301 | 1,3250 | 1,8130 | 135 | 1.620 |
| 40 mm | 1,1652 | 1,9887 | 2,5633 | 3,3868 | 48 | 576 |

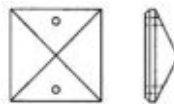

B.4732

| | | | | | | |
|-------|--------|--------|--------|--------|-----|-------|
| 30 mm | 0,7077 | 1,2380 | 1,5570 | 2,0873 | 135 | 1.620 |
| 40 mm | 0,9652 | 1,7887 | 2,1233 | 2,9469 | 60 | 720 |
| 50 mm | 1,3673 | 2,6928 | 3,0081 | 4,3336 | 50 | 600 |
| 60 mm | 2,1716 | 4,0585 | 4,7776 | 6,6644 | 22 | 264 |



B.4731

| | | | | | | |
|-------|--------|--------|--------|--------|-----|-------|
| 30 mm | 0,7077 | 1,2380 | 1,5570 | 2,0873 | 135 | 1.620 |
| 40 mm | 0,9652 | 1,7887 | 2,1233 | 2,9469 | 60 | 720 |
| 50 mm | 1,3673 | 2,6928 | 3,0081 | 4,3336 | 50 | 600 |
| 60 mm | 2,1716 | 4,0585 | 4,7776 | 6,6644 | 22 | 264 |

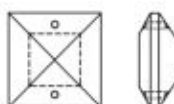

B.4243

| | | | | | | |
|-------|--------|--------|--------|--------|-----|-------|
| 18 mm | 0,3171 | 0,5097 | 0,6976 | 0,8902 | 384 | 4.608 |
| 20 mm | 0,3707 | 0,6081 | 0,8156 | 1,0530 | 336 | 4.032 |
| 22 mm | 0,4381 | 0,7026 | 0,9638 | 1,2284 | 336 | 4.032 |
| 24 mm | 0,5056 | 0,8170 | 1,1123 | 1,4237 | 189 | 2.268 |
| 26 mm | 0,6067 | 0,9804 | 1,3347 | 1,7084 | 162 | 1.944 |
| 28 mm | 0,7414 | 1,2144 | 1,6311 | 2,1041 | 162 | 1.944 |
| 30 mm | 0,8763 | 1,4066 | 1,9278 | 2,4581 | 135 | 1.620 |
| 40 mm | 2,1884 | 3,0120 | 4,8146 | 5,6381 | 48 | 576 |

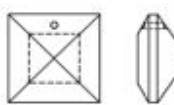

B.4246

| | | | | | | |
|-------|--------|--------|--------|--------|-----|-------|
| 18 mm | 0,3171 | 0,5097 | 0,6976 | 0,8902 | 384 | 4.608 |
| 20 mm | 0,3707 | 0,6081 | 0,8156 | 1,0530 | 336 | 4.032 |
| 22 mm | 0,4381 | 0,7026 | 0,9638 | 1,2284 | 336 | 4.032 |
| 24 mm | 0,5056 | 0,8170 | 1,1123 | 1,4237 | 189 | 2.268 |
| 26 mm | 0,6067 | 0,9804 | 1,3347 | 1,7084 | 162 | 1.944 |
| 28 mm | 0,7414 | 1,2144 | 1,6311 | 2,1041 | 162 | 1.944 |
| 30 mm | 0,8763 | 1,4066 | 1,9278 | 2,4581 | 135 | 1.620 |
| 40 mm | 2,1884 | 3,0120 | 4,8146 | 5,6381 | 48 | 576 |

| CRYSTAL | CRYSTAL coated | COLOR | COLOR coated | minimum quantity | |
|---------------|--|--|--|---------------------|------------------|
| CLEAR | AB AFLAME AMBER ANTIQUÉ GOLD SILVER | ALEXANDRITE AMETHYST AQUAMARINE EMERALD JET RODALIN RUBY SAPPHIRE SMOKE TOPAZ | AB AFLAME AMBER ANTIQUÉ GOLD SILVER | | |
| EURO piece | EURO piece | EURO piece | EURO piece | BOX pieces | CARTON pieces |



B.4350

| | | | | | | |
|-------|--------|--------|--------|--------|-----|-------|
| 18 mm | 0,2348 | 0,4273 | 0,5437 | 0,7362 | 384 | 4.608 |
| 20 mm | 0,2882 | 0,5256 | 0,6673 | 0,9047 | 336 | 4.032 |
| 22 mm | 0,3362 | 0,6007 | 0,7397 | 1,0042 | 336 | 4.032 |
| 24 mm | 0,3972 | 0,7087 | 0,8739 | 1,1853 | 189 | 2.268 |
| 26 mm | 0,4584 | 0,8321 | 1,0084 | 1,3822 | 162 | 1.944 |
| 28 mm | 0,5502 | 1,0231 | 1,2104 | 1,6834 | 162 | 1.944 |
| 30 mm | 0,6723 | 1,2026 | 1,4791 | 2,0094 | 135 | 1.620 |



B.4351

| | | | | | | |
|-------|--------|--------|--------|--------|-----|-------|
| 18 mm | 0,2543 | 0,4468 | 0,6214 | 0,8139 | 384 | 4.608 |
| 20 mm | 0,3033 | 0,5408 | 0,7414 | 0,9788 | 336 | 4.032 |
| 22 mm | 0,3475 | 0,6120 | 0,8492 | 1,1138 | 336 | 4.032 |
| 24 mm | 0,4053 | 0,7167 | 0,9909 | 1,3023 | 189 | 2.268 |
| 26 mm | 0,4777 | 0,8515 | 1,1680 | 1,5417 | 162 | 1.944 |
| 28 mm | 0,5791 | 1,0520 | 1,4155 | 1,8884 | 162 | 1.944 |
| 30 mm | 0,6949 | 1,2251 | 1,6986 | 2,2289 | 135 | 1.620 |



B.4353

| | | | | | | |
|-------|--------|--------|--------|--------|-----|-------|
| 18 mm | 0,2543 | 0,4468 | 0,6214 | 0,8139 | 384 | 4.608 |
| 20 mm | 0,3033 | 0,5408 | 0,7414 | 0,9788 | 336 | 4.032 |
| 22 mm | 0,3475 | 0,6120 | 0,8492 | 1,1138 | 336 | 4.032 |
| 24 mm | 0,4053 | 0,7167 | 0,9909 | 1,3023 | 189 | 2.268 |
| 26 mm | 0,4777 | 0,8515 | 1,1680 | 1,5417 | 162 | 1.944 |
| 28 mm | 0,5791 | 1,0520 | 1,4155 | 1,8884 | 162 | 1.944 |
| 30 mm | 0,6949 | 1,2251 | 1,6986 | 2,2289 | 135 | 1.620 |



B.4354

| | | | | | | |
|-------|--------|--------|--------|--------|-----|-------|
| 18 mm | 0,2543 | 0,4468 | 0,6214 | 0,8139 | 384 | 4.608 |
| 20 mm | 0,3033 | 0,5408 | 0,7414 | 0,9788 | 336 | 4.032 |
| 22 mm | 0,3475 | 0,6120 | 0,8492 | 1,1138 | 336 | 4.032 |
| 24 mm | 0,4053 | 0,7167 | 0,9909 | 1,3023 | 189 | 2.268 |
| 26 mm | 0,4777 | 0,8515 | 1,1680 | 1,5417 | 162 | 1.944 |
| 28 mm | 0,5791 | 1,0520 | 1,4155 | 1,8884 | 162 | 1.944 |
| 30 mm | 0,6949 | 1,2251 | 1,6986 | 2,2289 | 135 | 1.620 |
| 32 mm | 1,1822 | 1,5134 | | | 96 | 1.152 |
| 34 mm | 1,3706 | 1,7951 | | | 60 | 720 |
| 36 mm | 1,5590 | 2,0630 | | | 48 | 576 |
| 38 mm | 1,7929 | 2,3629 | | | 40 | 480 |
| 40 mm | 2,0268 | 2,6020 | | | 40 | 480 |

| CRYSTAL | CRYSTAL <u>coated</u> | COLOR | COLOR <u>coated</u> | minimum quantity | |
|---------------|--|---|--|---------------------|------------------|
| CLEAR | AB AFLAME AMBER ANTIQUÉ GOLD SILVER | ALEXANDRITE AMETHYST AQUAMARINE EMERALD JET ROSA LIN RUBY SAPPHIRE SMOKE TOPAZ | AB AFLAME AMBER ANTIQUÉ GOLD SILVER | | |
| | BB BW OG OS VL VM | | BB BW OG OS VL VM | | |
| EURO piece | EURO piece | EURO piece | EURO piece | BOX pieces | CARTON pieces |

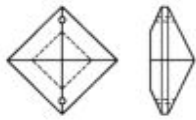

B.4250

| | | | | | | |
|-------|--------|--------|--------|--------|-----|-------|
| 18 mm | 0,3322 | 0,5248 | 0,7308 | 0,9234 | 384 | 4.608 |
| 20 mm | 0,3883 | 0,6258 | 0,8544 | 1,0918 | 336 | 4.032 |
| 22 mm | 0,4381 | 0,7026 | 0,9638 | 1,2284 | 336 | 4.032 |
| 24 mm | 0,5056 | 0,8170 | 1,1123 | 1,4237 | 189 | 2.268 |
| 26 mm | 0,6067 | 0,9804 | 1,3347 | 1,7084 | 162 | 1.944 |
| 28 mm | 0,7414 | 1,2144 | 1,6311 | 2,1041 | 162 | 1.944 |
| 30 mm | 0,8763 | 1,4066 | 1,9278 | 2,4581 | 135 | 1.620 |

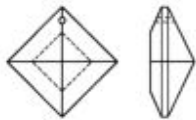

B.4251

| | | | | | | |
|-------|--------|--------|--------|--------|-----|-------|
| 18 mm | 0,3691 | 0,5617 | 0,8121 | 1,0047 | 384 | 4.608 |
| 20 mm | 0,4236 | 0,6611 | 0,9321 | 1,1696 | 336 | 4.032 |
| 22 mm | 0,4718 | 0,7363 | 1,0380 | 1,3024 | 336 | 4.032 |
| 24 mm | 0,5561 | 0,8676 | 1,2235 | 1,5350 | 189 | 2.268 |
| 26 mm | 0,6740 | 1,0478 | 1,4828 | 1,8566 | 162 | 1.944 |
| 28 mm | 0,8426 | 1,3156 | 1,8538 | 2,3268 | 162 | 1.944 |
| 30 mm | 0,9774 | 1,5077 | 2,1502 | 2,6805 | 135 | 1.620 |

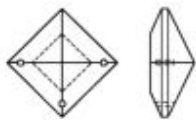

B.4253

| | | | | | | |
|-------|--------|--------|--------|--------|-----|-------|
| 18 mm | 0,3691 | 0,5617 | 0,8121 | 1,0047 | 384 | 4.608 |
| 20 mm | 0,4236 | 0,6611 | 0,9321 | 1,1696 | 336 | 4.032 |
| 22 mm | 0,4718 | 0,7363 | 1,0378 | 1,3024 | 336 | 4.032 |
| 24 mm | 0,5561 | 0,8676 | 1,2235 | 1,5350 | 189 | 2.268 |
| 26 mm | 0,6740 | 1,0478 | 1,4828 | 1,8566 | 162 | 1.944 |
| 28 mm | 0,8426 | 1,3156 | 1,8538 | 2,3268 | 162 | 1.944 |
| 30 mm | 0,9774 | 1,5077 | 2,1502 | 2,6805 | 135 | 1.620 |

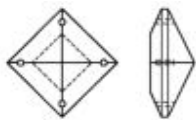

B.4254

| | | | | | | |
|-------|--------|--------|--------|--------|-----|-------|
| 18 mm | 0,3691 | 0,5617 | 0,8121 | 1,0047 | 384 | 4.608 |
| 20 mm | 0,4236 | 0,6611 | 0,9321 | 1,1696 | 336 | 4.032 |
| 22 mm | 0,4718 | 0,7363 | 1,0378 | 1,3024 | 336 | 4.032 |
| 24 mm | 0,5561 | 0,8676 | 1,2235 | 1,5350 | 189 | 2.268 |
| 26 mm | 0,6740 | 1,0478 | 1,4828 | 1,8566 | 162 | 1.944 |
| 28 mm | 0,8426 | 1,3156 | 1,8538 | 2,3268 | 162 | 1.944 |
| 30 mm | 0,9774 | 1,5077 | 2,1502 | 2,6805 | 135 | 1.620 |

| CRYSTAL | CRYSTAL <u>coated</u> | COLOR | COLOR <u>coated</u> | minimum quantity | |
|---------------|--|---|--|---------------------|------------------|
| CLEAR | AB AFLAME AMBER ANTIQUÉ GOLD SILVER | ALEXANDRITE AMETHYST AQUAMARINE EMERALD JET ROSA LIN RUBY SAPPHIRE SMOKE TOPAZ | AB AFLAME AMBER ANTIQUÉ GOLD SILVER | | |
| | BB BW OG OS VL VM | | BB BW OG OS VL VM | | |
| EURO piece | EURO piece | EURO piece | EURO piece | BOX pieces | CARTON pieces |



B.4022

| | | | | | | |
|--------|----------|---------|---------|---------|-----|-------|
| 15 mm | 0,7976 | 0,9967 | | | 320 | 3.840 |
| 20 mm | 1,1263 | 1,4849 | 2,1233 | 2,9383 | 120 | 1.440 |
| 30 mm | 1,1796 | 1,7771 | 2,6141 | 3,3902 | 72 | 864 |
| 40 mm | 2,0221 | 2,7509 | 4,3793 | 5,5624 | 34 | 408 |
| 50 mm | 6,1506 | 7,3109 | 14,1757 | 15,3357 | 12 | 144 |
| 60 mm | 13,9717 | 16,8388 | 37,0721 | 38,7735 | 10 | 120 |
| 70 mm | 25,9566 | 30,6604 | | | 4 | 48 |
| 80 mm | 46,2019 | | | | 1 | 27 |
| 90 mm | 71,0799 | | | | 1 | 27 |
| 100 mm | 84,0921 | | | | 1 | 27 |
| 125 mm | 120,1350 | | | | 1 | 8 |
| 150 mm | 160,1800 | | | | 1 | 8 |



B.4222

| | | | | | | |
|-------|--------|--------|--|--|----|-----|
| 20 mm | 2,8309 | 3,2384 | | | 72 | 864 |
| 30 mm | 3,6397 | 4,0472 | | | 40 | 480 |
| 40 mm | 4,3653 | 5,1935 | | | 20 | 240 |



B.4322

| | | | | | | |
|----------|--------|--------|--|--|----|-----|
| 63x30 mm | 1,2059 | 2,6310 | | | 16 | 192 |
| 76x35 mm | 2,3739 | 4,0304 | | | 16 | 192 |
| 89x40 mm | 3,0134 | 5,8585 | | | 10 | 120 |



B.4023

| | | | | | | |
|-------|---------|---------|---------|---------|-----|-------|
| 20 mm | 1,0681 | 1,4267 | 2,3497 | 2,7082 | 120 | 1.440 |
| 30 mm | 1,1121 | 1,7096 | 2,6915 | 3,2890 | 72 | 864 |
| 40 mm | 1,9379 | 2,6667 | 4,6898 | 5,4186 | 34 | 408 |
| 50 mm | 5,8135 | 6,9736 | 13,3989 | 14,5590 | 12 | 144 |
| 60 mm | 13,8601 | 15,5599 | 37,0721 | 38,7720 | 10 | 120 |
| 70 mm | 25,6047 | 28,5261 | | | 4 | 48 |



B.4014

| | | | | | | |
|-------|---------|---------|---------|---------|-----|-------|
| 20 mm | 0,9710 | 1,3224 | 2,1362 | 2,4876 | 120 | 1.440 |
| 30 mm | 1,0592 | 1,6433 | 2,3302 | 2,9144 | 72 | 864 |
| 40 mm | 1,8537 | 2,6853 | 4,0781 | 4,9097 | 34 | 408 |
| 50 mm | 4,9750 | 6,0833 | 10,9451 | 12,0534 | 12 | 144 |
| 60 mm | 12,4741 | 14,1854 | 27,4430 | 29,1543 | 10 | 120 |



B.4015

| | | | | | | |
|-------|---------|---------|---------|---------|-----|-------|
| 20 mm | 0,9710 | 1,3224 | 2,1362 | 2,4876 | 120 | 1.440 |
| 30 mm | 1,0592 | 1,6433 | 2,3302 | 2,9144 | 72 | 864 |
| 40 mm | 1,8537 | 2,6853 | 4,0781 | 4,9097 | 34 | 408 |
| 50 mm | 4,9750 | 6,0833 | 10,9451 | 12,0534 | 12 | 144 |
| 60 mm | 12,4741 | 14,1854 | 27,4430 | 29,1543 | 10 | 120 |

| CRYSTAL | CRYSTAL coated | COLOR | COLOR coated | minimum quantity | |
|---------------|--|---|--|---------------------|------------------|
| CLEAR | AB AFLAME AMBER ANTIQUÉ GOLD SILVER | ALEXANDRITE AMETHYST AQUAMARINE EMERALD JET ROSA LIN RUBY SAPPHIRE SMOKE TOPAZ | AB AFLAME AMBER ANTIQUÉ GOLD SILVER | | |
| | BB BW OG OS VL VM | | BB BW OG OS VL VM | | |
| EURO piece | EURO piece | EURO piece | EURO piece | BOX pieces | CARTON pieces |



B.4016

| | | | | | | |
|-----------|--------|---------|---------|---------|-----|-------|
| 38x14 mm | 0,2975 | 0,6200 | 0,6545 | 0,9764 | 360 | 4.320 |
| 50x15 mm | 0,5438 | 0,8894 | 1,1963 | 1,5420 | 180 | 2.160 |
| 63x16 mm | 0,7381 | 1,2401 | 1,6238 | 2,1259 | 80 | 960 |
| 76x17 mm | 1,0877 | 2,0103 | 2,3930 | 3,3156 | 70 | 840 |
| 89x18 mm | 1,7131 | 2,6478 | 3,7688 | 4,7035 | 60 | 720 |
| 100x19 mm | 2,5698 | 3,5251 | 5,6533 | 6,6087 | 60 | 720 |
| 115x20 mm | 3,8544 | 5,5100 | 8,4799 | 10,1354 | 24 | 288 |
| 125x22 mm | 5,7817 | 7,6388 | 12,7197 | 14,5768 | 24 | 288 |
| 150x24 mm | 8,6726 | 11,2623 | 19,0798 | 21,6696 | 18 | 216 |

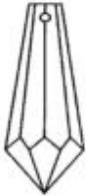

B.4216

| | | | | | | |
|-----------|--------|--------|--------|--------|-----|-------|
| 38x16 mm | 0,4730 | 0,9359 | 1,0405 | 1,5035 | 300 | 3.600 |
| 50x18 mm | 0,6434 | 1,1491 | 1,4155 | 1,9212 | 150 | 1.800 |
| 63x20 mm | 0,9652 | 1,5410 | 2,1233 | 2,6992 | 80 | 960 |
| 76x22 mm | 1,4477 | 2,4546 | 3,1849 | 4,1918 | 56 | 672 |
| 89x24 mm | 2,0681 | 3,1888 | 4,5500 | 5,6706 | 40 | 480 |
| 100x26 mm | 3,1023 | 5,1980 | 6,8250 | 8,9207 | 40 | 480 |



B.4130

| | | | | | | |
|-----------|--------|--------|---------|---------|-----|-------|
| 38x10 mm | 0,5179 | 0,7408 | 1,1394 | 1,3623 | 420 | 5.040 |
| 50x11 mm | 0,6215 | 0,9671 | 1,3673 | 1,7129 | 420 | 5.040 |
| 63x12 mm | 0,7732 | 1,2029 | 1,7011 | 2,1062 | 256 | 3.072 |
| 76x13 mm | 1,1288 | 1,8851 | 2,4834 | 3,2397 | 196 | 2.352 |
| 89x14 mm | 1,5200 | 2,4547 | 3,3439 | 4,2787 | 100 | 1.200 |
| 100x15 mm | 2,0911 | 3,2165 | 4,6004 | 5,7258 | 100 | 1.200 |
| 115x16 mm | 3,2170 | 4,5851 | 7,0774 | 8,4455 | 36 | 432 |
| 125x18 mm | 4,5957 | 6,4528 | 10,1106 | 11,9677 | 30 | 360 |
| 150x20 mm | 6,8936 | 9,1444 | 15,1659 | 17,4167 | 24 | 288 |

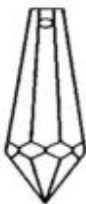

B.4230

| | | | | | | |
|-----------|--------|--------|--------|--------|-----|-------|
| 38x18 mm | 0,7007 | 1,1637 | 1,5415 | 2,0045 | 300 | 3.600 |
| 50x20 mm | 0,8445 | 1,3502 | 1,8578 | 2,3635 | 150 | 1.800 |
| 63x22 mm | 1,1823 | 1,7581 | 2,6009 | 3,1768 | 64 | 768 |
| 76x24 mm | 1,6889 | 2,6958 | 3,7157 | 4,7226 | 56 | 672 |
| 89x26 mm | 2,3644 | 3,4850 | 5,2018 | 6,3224 | 40 | 480 |
| 100x28 mm | 3,3779 | 5,4737 | 7,4313 | 9,5271 | 40 | 480 |



B.4136

| | | | | | | |
|-----------|--------|---------|---------|---------|-----|-------|
| 38x11 mm | 0,7291 | 0,9520 | 1,6039 | 1,8268 | 420 | 5.040 |
| 50x12 mm | 0,7990 | 1,1940 | 1,7577 | 2,1527 | 240 | 2.880 |
| 63x13 mm | 0,8954 | 1,3250 | 1,9699 | 2,3749 | 192 | 2.304 |
| 76x14 mm | 1,2457 | 2,0020 | 2,7405 | 3,4968 | 98 | 1.176 |
| 89x15 mm | 1,7693 | 2,7041 | 3,8925 | 4,8273 | 80 | 960 |
| 100x16 mm | 2,4127 | 3,5381 | 5,3080 | 6,4334 | 80 | 960 |
| 115x17 mm | 3,8604 | 5,2285 | 8,4929 | 9,8609 | 36 | 432 |
| 125x19 mm | 5,5149 | 7,3720 | 12,1327 | 13,9898 | 30 | 360 |
| 150x21 mm | 8,2723 | 10,5231 | 18,1990 | 20,4498 | 24 | 288 |

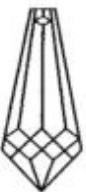

B.4236

| | | | | | | |
|-----------|--------|--------|--------|---------|-----|-------|
| 38x18 mm | 0,8360 | 1,2990 | 1,8392 | 2,3022 | 150 | 1.800 |
| 50x20 mm | 0,9290 | 1,4347 | 2,0436 | 2,5493 | 150 | 1.800 |
| 63x22 mm | 1,3005 | 1,8763 | 2,8610 | 3,4369 | 64 | 768 |
| 76x24 mm | 2,0436 | 3,0505 | 4,4960 | 5,5029 | 56 | 672 |
| 89x26 mm | 2,6009 | 3,7215 | 5,7220 | 6,8426 | 40 | 480 |
| 100x28 mm | 3,7157 | 5,8115 | 8,1744 | 10,2702 | 40 | 480 |

| CRYSTAL | CRYSTAL coated | COLOR | COLOR coated | minimum quantity | |
|---------------|--|---|--|---------------------|------------------|
| CLEAR | AB AFLAME AMBER ANTIQUÉ GOLD SILVER | ALEXANDRITE AMETHYST AQUAMARINE EMERALD JET ROSA LIN RUBY SAPPHIRE SMOKE TOPAZ | AB AFLAME AMBER ANTIQUÉ GOLD SILVER | | |
| | BB BW OG OS VL VM | | BB BW OG OS VL VM | | |
| EURO piece | EURO piece | EURO piece | EURO piece | BOX pieces | CARTON pieces |



B.4124
38x20 mm

| | | | | | |
|--------|--------|--------|--------|-----|-------|
| 0,5067 | 0,9921 | 1,1146 | 1,6001 | 240 | 2.880 |
|--------|--------|--------|--------|-----|-------|

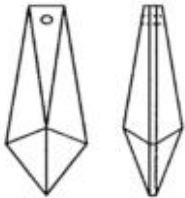

B.4128
58x16 mm

| | | | | | |
|--------|--------|--------|--------|-----|-------|
| 0,7077 | 1,4088 | 1,5570 | 2,2580 | 112 | 1.344 |
|--------|--------|--------|--------|-----|-------|

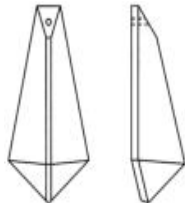

B.4119
50x24 mm

| | | | | | |
|--------|--------|--------|--------|----|-------|
| 0,7660 | 1,4636 | 1,6851 | 2,3827 | 90 | 1.080 |
|--------|--------|--------|--------|----|-------|

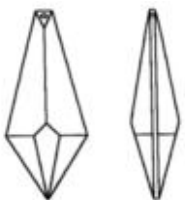

B.4129
76x25 mm

| | | | | | |
|--------|--------|--------|--------|----|-----|
| 1,4477 | 2,7023 | 3,1848 | 4,4394 | 80 | 960 |
|--------|--------|--------|--------|----|-----|

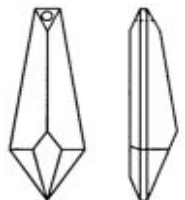

B.4118
63x24 mm
76x24 mm
89x24 mm
100x24 mm

| | | | | | |
|--------|--------|--------|--------|----|-------|
| 0,8024 | 1,8103 | 1,7653 | 2,7732 | 96 | 1.152 |
| 1,1672 | 2,1751 | 2,5678 | 3,5757 | 70 | 840 |
| 1,6778 | 2,7986 | 3,6912 | 4,8120 | 60 | 720 |
| 2,4073 | 3,7459 | 5,2960 | 6,6346 | 50 | 600 |

| CRYSTAL | CRYSTAL coated | COLOR | COLOR coated | minimum quantity | |
|---------------|--|---|--|---------------------|------------------|
| CLEAR | AB AFLAME AMBER ANTIQUÉ GOLD SILVER | ALEXANDRITE AMETHYST AQUAMARINE EMERALD JET ROSA LIN RUBY SAPPHIRE SMOKE TOPAZ | AB AFLAME AMBER ANTIQUÉ GOLD SILVER | | |
| | BB BW OG OS VL VM | | BB BW OG OS VL VM | | |
| EURO piece | EURO piece | EURO piece | EURO piece | BOX pieces | CARTON pieces |

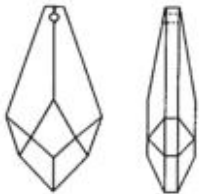

B.4131

38x19 mm
50x25 mm
63x31 mm
76x38 mm

| | | | | | |
|--------|--------|--------|--------|-----|-------|
| 0,5443 | 1,0174 | 1,1975 | 1,6706 | 162 | 1.944 |
| 0,7047 | 1,4057 | 1,5501 | 2,2511 | 90 | 1.080 |
| 1,0723 | 2,1227 | 2,3591 | 3,4095 | 48 | 576 |
| 1,6889 | 3,3579 | 3,7157 | 5,3847 | 30 | 360 |

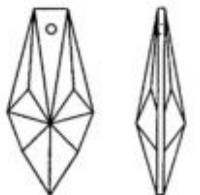

B.4137

50x20 mm
63x25 mm
76x30 mm

| | | | | | |
|--------|--------|--------|--------|-----|-------|
| 0,6694 | 1,1944 | 1,4726 | 2,1339 | 180 | 2.160 |
| 1,0197 | 1,9833 | 2,2433 | 3,2070 | 80 | 960 |
| 1,5510 | 2,8893 | 3,4122 | 4,7505 | 40 | 480 |

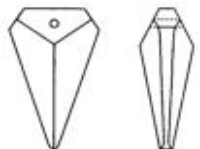

B.4120

28x15 mm
38x20 mm

| | | | | | |
|--------|--------|--------|--------|-----|-------|
| 0,6409 | 1,0214 | 1,4098 | 1,7903 | 480 | 5.760 |
| 0,6991 | 1,1895 | 1,5380 | 2,0284 | 210 | 2.520 |

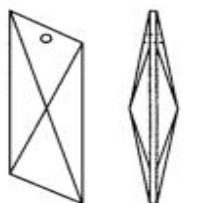

B.4121

70x22 mm
85x35 mm

| | | | | | |
|--------|--------|--------|--------|----|-----|
| 1,2036 | 2,3130 | 2,6480 | 3,7574 | 70 | 840 |
| 2,2979 | 4,4374 | 5,0553 | 7,1948 | 40 | 480 |

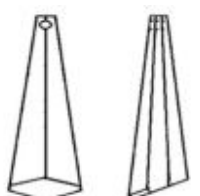

B.4031

63x16 mm
76x20 mm
89x23 mm

| | | | | | |
|--------|--------|--------|--------|-----|-------|
| 0,7370 | 1,3129 | 1,6214 | 2,1973 | 128 | 1.536 |
| 1,0856 | 2,0088 | 2,3883 | 3,3115 | 84 | 1.008 |
| 1,7862 | 2,9448 | 3,9295 | 5,0882 | 50 | 600 |

| CRYSTAL | CRYSTAL coated | COLOR | COLOR coated | minimum quantity | |
|---------------|--|---|--|---------------------|------------------|
| CLEAR | AB AFLAME AMBER ANTIQUÉ GOLD SILVER | ALEXANDRITE AMETHYST AQUAMARINE EMERALD JET ROSA LIN RUBY SAPPHIRE SMOKE TOPAZ | AB AFLAME AMBER ANTIQUÉ GOLD SILVER | | |
| | BB BW OG OS VL VM | | BB BW OG OS VL VM | | |
| EURO piece | EURO piece | EURO piece | EURO piece | BOX pieces | CARTON pieces |

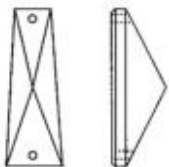

B.4009

52x18x14 mm
58x26x18 mm
63x30x22 mm

0,4811
0,7400
0,9437

1,1382
1,8550
2,1562

1,0583
1,6279
2,0761

1,7154
2,7429
3,2886

210
112
70

2.520
1.344
840

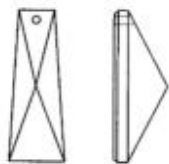

B.4011

52x18x14 mm
58x26x18 mm
63x30x22 mm

0,4811
0,7400
0,9437

1,1382
1,8550
2,1562

1,0583
1,6279
2,0761

1,7154
2,7429
3,2886

210
112
70

2.520
1.344
840

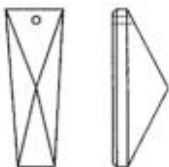

B.4010

52x18x14 mm
58x26x18 mm
63x30x22 mm

0,4811
0,7400
0,9437

1,1382
1,8550
2,1562

1,0583
1,6279
2,0761

1,7154
2,7429
3,2886

210
112
70

2.520
1.344
840

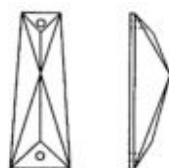

B.4005

52x18x16 mm
58x26x20 mm
63x30x24 mm

0,5945
0,8847
1,2031

1,2516
1,9997
2,4156

1,3079
1,9462
2,6469

1,9650
3,0613
3,8594

210
112
84

2.520
1.344
1.008



B.4007

52x18x16 mm
58x26x20 mm
63x30x24 mm

0,5945
0,8847
1,2031

1,2516
1,9997
2,4156

1,3079
1,9462
2,6469

1,9650
3,0613
3,8594

210
112
84

2.520
1.344
1.008

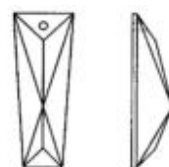

B.4006

52x18x16 mm
58x26x20 mm
63x30x24 mm

0,5945
0,8847
1,2031

1,2516
1,9997
2,4156

1,3079
1,9462
2,6469

1,9650
3,0613
3,8594

210
112
84

2.520
1.344
1.008

| CRYSTAL | CRYSTAL coated | COLOR | COLOR coated | minimum quantity | |
|---------------|--|---|--|---------------------|------------------|
| CLEAR | AB AFLAME AMBER ANTIQUÉ GOLD SILVER | ALEXANDRITE AMETHYST AQUAMARINE EMERALD JET ROSA LIN RUBY SAPPHIRE SMOKE TOPAZ | AB AFLAME AMBER ANTIQUÉ GOLD SILVER | | |
| EURO piece | EURO piece | EURO piece | EURO piece | BOX pieces | CARTON pieces |

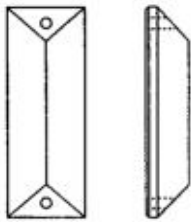

B.4132

50x22 mm
63x22 mm
76x22 mm
89x22 mm
100x22 mm
115x22 mm
125x24 mm
150x26 mm
175x28 mm
200x30 mm

| | | | | | |
|--------|---------|---------|---------|-----|-------|
| 0,5285 | 1,2259 | 1,1628 | 1,8601 | 180 | 2.160 |
| 0,7400 | 1,6431 | 1,6279 | 2,5310 | 112 | 1.344 |
| 0,9437 | 1,9593 | 2,0761 | 3,0918 | 84 | 1.008 |
| 1,2546 | 2,4211 | 2,7601 | 3,9266 | 80 | 960 |
| 1,9149 | 3,2257 | 4,2129 | 5,5237 | 70 | 840 |
| 2,5277 | 4,2654 | 5,5609 | 7,2985 | 48 | 576 |
| 3,5234 | 5,4895 | 7,7514 | 9,7175 | 42 | 504 |
| 4,9327 | 9,7715 | 10,8520 | 15,6908 | 36 | 432 |
| 6,9058 | 14,7824 | 13,8121 | 21,6887 | 18 | 216 |
| 9,6681 | 17,5447 | 21,2701 | 29,1468 | 15 | 180 |

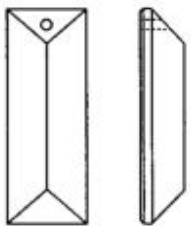

B.4135

50x22 mm
63x22 mm
76x22 mm
89x22 mm
100x22 mm
115x22 mm
125x24 mm
150x26 mm
175x28 mm
200x30 mm

| | | | | | |
|--------|---------|---------|---------|-----|-------|
| 0,5285 | 1,2259 | 1,1628 | 1,8601 | 180 | 2.160 |
| 0,7400 | 1,6431 | 1,6279 | 2,5310 | 112 | 1.344 |
| 0,9437 | 1,9593 | 2,0761 | 3,0918 | 84 | 1.008 |
| 1,2546 | 2,4211 | 2,7601 | 3,9266 | 80 | 960 |
| 1,9149 | 3,2257 | 4,2129 | 5,5237 | 70 | 840 |
| 2,5277 | 4,2654 | 5,5609 | 7,2985 | 48 | 576 |
| 3,5234 | 5,4895 | 7,7514 | 9,7175 | 42 | 504 |
| 4,9327 | 9,7715 | 10,8520 | 15,6908 | 36 | 432 |
| 6,9058 | 14,7824 | 13,8121 | 21,6887 | 18 | 216 |
| 9,6681 | 17,5447 | 21,2701 | 29,1468 | 15 | 180 |

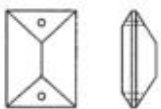

B.4020

20x14 mm
26x18 mm
32x22 mm
38x26 mm

| | | | | | |
|--------|--------|--------|--------|-----|-------|
| 0,5349 | 0,7137 | 1,1767 | 1,3555 | 336 | 4.032 |
| 0,6524 | 0,9541 | 1,4355 | 1,7371 | 162 | 1.944 |
| 0,8156 | 1,2649 | 1,7943 | 2,2436 | 96 | 1.152 |
| 1,0195 | 1,6504 | 2,2428 | 2,8736 | 96 | 1.152 |

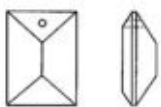

B.4021

20x14 mm
26x18 mm
32x22 mm
38x26 mm

| | | | | | |
|--------|--------|--------|--------|-----|-------|
| 0,5349 | 0,7137 | 1,1767 | 1,3555 | 336 | 4.032 |
| 0,6524 | 0,9541 | 1,4355 | 1,7371 | 162 | 1.944 |
| 0,8156 | 1,2649 | 1,7943 | 2,2436 | 96 | 1.152 |
| 1,0195 | 1,6504 | 2,2428 | 2,8736 | 96 | 1.152 |



B.4580

50x32 mm

| | | | | | |
|--------|--------|--------|--------|----|-----|
| 1,2264 | 2,0785 | 1,9856 | 2,8377 | 70 | 840 |
|--------|--------|--------|--------|----|-----|

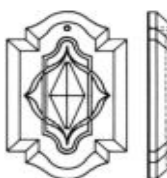

B.4581

50x32 mm

| | | | | | |
|--------|--------|--------|--------|----|-----|
| 1,2264 | 2,0785 | 1,9856 | 2,8377 | 70 | 840 |
|--------|--------|--------|--------|----|-----|

| CRYSTAL | CRYSTAL <u>coated</u> | COLOR | COLOR <u>coated</u> | minimum quantity | |
|---------------|--|---|--|---------------------|------------------|
| CLEAR | AB AFLAME AMBER ANTIQUÉ GOLD SILVER | ALEXANDRITE AMETHYST AQUAMARINE EMERALD JET ROSA LIN RUBY SAPPHIRE SMOKE TOPAZ | AB AFLAME AMBER ANTIQUÉ GOLD SILVER | | |
| | BB BW OG OS VL VM | | BB BW OG OS VL VM | | |
| EURO piece | EURO piece | EURO piece | EURO piece | BOX pieces | CARTON pieces |



B.4134

63x18 mm
76x18 mm
89x18 mm
100x18 mm

0,6087
0,7966
1,1336
1,6851

1,5117
1,8123
2,3002
2,9958

1,3391
1,7525
2,4939
3,7072

2,2422
2,7681
3,6604
5,0179

144
126
90
80

1.728
1.512
1.080
960

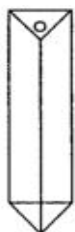

B.4133

63x20 mm
76x20 mm
89x20 mm
100x20 mm
115x22 mm
125x24 mm
150x26 mm
175x28 mm
200x30 mm

0,6740
0,9100
1,2807
2,0221
2,5277
3,3365
4,8193
6,8233
9,4227

1,5771
1,9257
2,4472
3,3328
4,2654
5,3026
9,6581
14,6999
17,2994

1,4828
2,0020
2,8175
4,4486
5,5608
7,3403
10,6027
12,9967
18,8455

2,3859
3,0176
3,9841
5,7593
7,2985
9,3064
15,4415
20,8733
26,7221

144
112
90
80
48
42
36
18
15

1.728
1.344
1.080
960
576
504
432
216
180

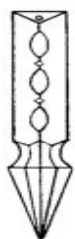

B.4335

63x12 mm
76x14 mm
89x16 mm
100x18 mm
115x20 mm
125x22 mm
150x24 mm

0,7414
1,0111
1,5319
2,2979
3,6766
5,8212
9,9574

1,5672
2,0072
2,6984
3,6086
4,6949
7,2080
14,7962

1,6311
2,2244
3,3702
5,0553
8,0885
12,8067
21,9062

2,4569
3,2205
4,5367
6,3660
9,1068
14,1935
26,7450

112
84
84
50
24
24
18

1.344
1.008
1.008
600
288
288
216



B.4340

125x18 mm

4,5551

6,4731

6,2852

8,2032

32

384

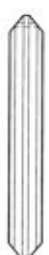
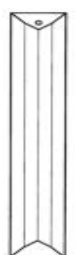

B.4541

100x20 mm
125x20 mm
150x20 mm

5,2013
7,2818
9,3622

7,0539
9,6345
14,8609

7,9598
10,6228
13,9077

9,8124
12,9755
19,4064

40
40
40

480
480
480

| CRYSTAL | CRYSTAL <u>coated</u> | COLOR | COLOR <u>coated</u> | minimum quantity | |
|---------------|--|---|--|---------------------|------------------|
| CLEAR | AB AFLAME AMBER ANTIQUÉ GOLD SILVER | ALEXANDRITE AMETHYST AQUAMARINE EMERALD JET ROSA LIN RUBY SAPPHIRE SMOKE TOPAZ | AB AFLAME AMBER ANTIQUÉ GOLD SILVER | | |
| | BB BW OG OS VL VM | | BB BW OG OS VL VM | | |
| EURO piece | EURO piece | EURO piece | EURO piece | BOX pieces | CARTON pieces |

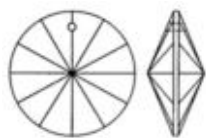

B.4037

| | | | | | | |
|-------|--------|--------|--------|--------|-----|-------|
| 20 mm | 0,8140 | 1,0469 | 1,7905 | 2,0235 | 420 | 5.040 |
| 25 mm | 0,8140 | 1,1461 | 1,7905 | 2,0320 | 210 | 2.520 |
| 30 mm | 0,8140 | 1,3105 | 1,7905 | 2,2734 | 162 | 1.944 |
| 35 mm | 0,8847 | 1,4483 | 1,9462 | 2,5098 | 80 | 960 |
| 40 mm | 0,9483 | 1,7316 | 2,0863 | 2,8696 | 80 | 960 |
| 50 mm | 1,3131 | 2,2883 | 2,8887 | 3,8640 | 40 | 480 |

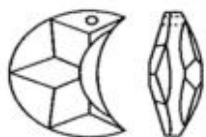

B.4038

| | | | | | | |
|-------|--------|--------|--------|--------|-----|-------|
| 20 mm | 0,8140 | 1,0469 | 1,7905 | 2,0235 | 420 | 5.040 |
| 25 mm | 0,8140 | 1,1125 | 1,7905 | 2,0701 | 210 | 2.520 |
| 30 mm | 0,8140 | 1,2740 | 1,7905 | 2,1931 | 162 | 1.944 |
| 35 mm | 0,9120 | 1,5567 | 2,0065 | 2,6512 | 100 | 1.200 |
| 40 mm | 0,9191 | 1,7025 | 2,0221 | 2,8054 | 80 | 960 |
| 50 mm | 1,2255 | 2,2008 | 2,6962 | 3,6714 | 40 | 480 |



B.4039

| | | | | | | |
|-------|--------|--------|--------|--------|-----|-------|
| 20 mm | 0,8156 | 1,0276 | 1,7943 | 2,0063 | 243 | 2.916 |
| 25 mm | 0,8156 | 1,1129 | 1,7943 | 2,0704 | 216 | 2.592 |
| 30 mm | 0,8156 | 1,2872 | 1,7943 | 2,1752 | 162 | 1.944 |
| 35 mm | 0,8445 | 1,5083 | 1,8578 | 2,5216 | 84 | 1.008 |
| 40 mm | 0,8847 | 1,7133 | 1,9462 | 2,7748 | 84 | 1.008 |
| 50 mm | 1,1259 | 2,4070 | 2,4770 | 3,7581 | 50 | 600 |

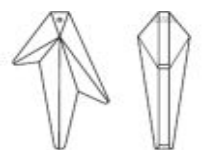

B.4549

| | | | | | | |
|-------|--------|--------|--------|--------|-----|-------|
| 20 mm | 0,8156 | 1,0276 | 1,7943 | 2,0063 | 400 | 4.800 |
| 30 mm | 0,8156 | 1,2872 | 1,7943 | 2,1752 | 216 | 2.592 |
| 40 mm | 0,8847 | 1,7133 | 1,9462 | 2,7748 | 140 | 1.680 |
| 50 mm | 1,0723 | 2,3534 | 2,3591 | 3,6402 | 120 | 1.440 |

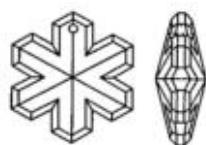

B.4113

| | | | | | | |
|-------|--------|--------|--------|--------|-----|-------|
| 20 mm | 0,7786 | 0,9833 | 1,7127 | 1,9174 | 243 | 2.916 |
| 25 mm | 0,7786 | 1,0370 | 1,7127 | 1,9903 | 243 | 2.916 |
| 30 mm | 0,7786 | 1,2008 | 1,7127 | 2,0465 | 189 | 2.268 |
| 35 mm | 0,8043 | 1,4490 | 1,7693 | 2,4141 | 100 | 1.200 |
| 40 mm | 0,8426 | 1,7546 | 1,8538 | 2,7658 | 100 | 1.200 |
| 50 mm | 1,0723 | 2,3534 | 2,3591 | 3,6402 | 50 | 600 |

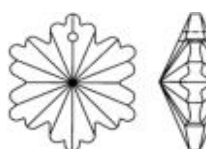

B.4205

| | | | | | | |
|-------|--------|--------|--|--|-----|-------|
| 20 mm | 0,9033 | 1,1532 | | | 420 | 5.040 |
| 30 mm | 1,3966 | 1,9097 | | | 60 | 720 |
| 40 mm | 1,6203 | 2,5130 | | | 36 | 432 |
| 50 mm | 2,5461 | 4,0760 | | | 30 | 360 |

| CRYSTAL | CRYSTAL coated | COLOR | COLOR coated | minimum quantity | |
|---------------|--|---|--|---------------------|------------------|
| CLEAR | AB AFLAME AMBER ANTIQUÉ GOLD SILVER | ALEXANDRITE AMETHYST AQUAMARINE EMERALD JET ROSA LIN RUBY SAPPHIRE SMOKE TOPAZ | AB AFLAME AMBER ANTIQUÉ GOLD SILVER | | |
| | BB BW OG OS VL VM | | BB BW OG OS VL VM | | |
| EURO piece | EURO piece | EURO piece | EURO piece | BOX pieces | CARTON pieces |

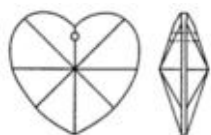

B.4114

| | | | | | | |
|-------|--------|--------|--------|--------|-------|--------|
| 10 mm | 0,1022 | 0,2352 | 0,1825 | 0,3155 | 1.800 | 21.600 |
| 14 mm | 0,1460 | 0,2790 | 0,2263 | 0,3593 | 900 | 10.800 |
| 20 mm | 0,7047 | 0,9168 | 1,5503 | 1,7624 | 420 | 5.040 |
| 25 mm | 0,7431 | 1,1406 | 1,6348 | 2,0323 | 210 | 2.520 |
| 30 mm | 0,7651 | 1,2365 | 1,6832 | 2,0824 | 162 | 1.944 |
| 35 mm | 0,8043 | 1,4490 | 1,7693 | 2,4141 | 80 | 960 |
| 40 mm | 0,8426 | 1,6348 | 1,8538 | 2,6460 | 80 | 960 |
| 50 mm | 1,0942 | 2,1653 | 2,4073 | 3,4783 | 40 | 480 |

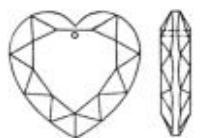

B.4115

| | | | | | | |
|-------|--------|--------|--------|--------|-----|-------|
| 28 mm | 1,1388 | 1,7051 | 1,6060 | 2,1723 | 135 | 1.620 |
| 40 mm | 1,3140 | 2,2144 | 1,8437 | 2,7440 | 70 | 840 |
| 50 mm | 1,5184 | 2,7356 | 2,1316 | 3,3489 | 60 | 720 |

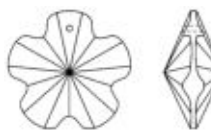

B.4214

| | | | | | | |
|-------|--------|--------|--------|--------|-----|-------|
| 28 mm | 1,3432 | 1,8514 | 1,8804 | 2,3887 | 135 | 1.620 |
| 40 mm | 1,7228 | 2,6850 | 2,4119 | 3,3741 | 60 | 720 |
| 50 mm | 2,1900 | 3,7199 | 3,0659 | 4,5961 | 36 | 432 |

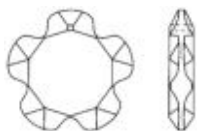

B.4215

| | | | | | | |
|-------|--------|--------|--------|--------|-----|-------|
| 28 mm | 1,1388 | 1,6470 | 1,6060 | 2,1025 | 135 | 1.620 |
| 40 mm | 1,3140 | 2,2762 | 1,8437 | 2,8018 | 70 | 840 |
| 50 mm | 1,5184 | 3,0486 | 2,1316 | 3,6559 | 60 | 720 |

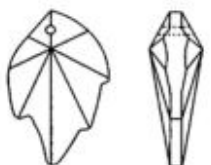

B.4112

| | | | | | | |
|----------|--------|--------|--------|--------|-----|-------|
| 20x12 mm | 0,7786 | 0,9427 | 1,7127 | 1,8768 | 500 | 6.000 |
| 26x16 mm | 0,7786 | 0,9611 | 1,7127 | 1,8068 | 240 | 2.880 |
| 32x20 mm | 0,7786 | 1,1109 | 1,7127 | 1,9566 | 240 | 2.880 |
| 45x28 mm | 0,9958 | 1,7020 | 2,1908 | 2,8970 | 140 | 1.680 |
| 55x35 mm | 1,8104 | 3,3235 | 2,7156 | 4,2287 | 70 | 840 |
| 80x50 mm | 4,0295 | 7,0259 | 6,0443 | 9,0406 | 32 | 384 |

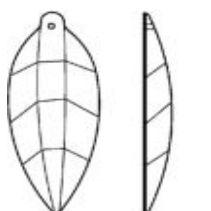

B.4117

| | | | | | | |
|----------|--------|--------|--------|--------|----|-----|
| 80x30 mm | 0,9052 | 3,1928 | 1,8104 | 3,3313 | 50 | 600 |
|----------|--------|--------|--------|--------|----|-----|

| CRYSTAL | CRYSTAL coated | COLOR | COLOR coated | minimum quantity | |
|---------------|--|--|--|---------------------|------------------|
| CLEAR | AB AFLAME AMBER ANTIQUÉ GOLD SILVER | ALEXANDRITE AMETHYST AQUAMARINE EMERALD JET ROSALIN RUBY SAPPHIRE SMOKE TOPAZ | AB AFLAME AMBER ANTIQUÉ GOLD SILVER | | |
| | BB BW OG OS VL VM | | BB BW OG OS VL VM | | |
| EURO piece | EURO piece | EURO piece | EURO piece | BOX pieces | CARTON pieces |

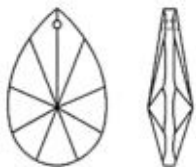

B.4035

28x17 mm
38x22 mm
50x29 mm
63x37 mm
76x44 mm
89x52 mm
100x58 mm
115x66 mm
125x74 mm
150x87 mm

0,4556
0,4949
0,6434
1,0111
1,5319
2,5277
3,9762
7,0774
11,6045
25,7307

0,7359
0,9333
1,3684
2,1749
3,2010
5,6478
9,1544
12,5030
18,9456
33,6485

1,0023
1,0886
1,4155
2,2244
3,3702
5,6955

1,2826
1,5271
2,1405
3,3882
5,0393
8,8156

240
162
90
48
30
18
15
8
6
4

2.880
1.944
1.080
576
360
216
180
96
72
48

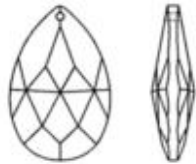

B.4032

28x17 mm
38x22 mm
50x29 mm
63x37 mm
76x44 mm
89x52 mm
100x58 mm
115x66 mm
125x74 mm
150x87 mm

0,4556
0,4949
0,6434
1,0111
1,5319
2,5277
3,9762
7,0774
11,6045
25,7307

0,7359
0,9333
1,3684
2,1749
3,2010
5,6478
9,1544
12,5030
18,9456
33,6485

1,0023
1,0886
1,4155
2,2244
3,3702
5,6955

1,2826
1,5271
2,1405
3,3882
5,0393
8,8156

240
162
90
48
30
18
15
8
6
4

2.880
1.944
1.080
576
360
216
180
96
72
48

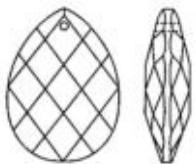

B.4030

28x18 mm
38x24 mm
50x32 mm
63x40 mm
76x48 mm
89x57 mm
100x64 mm
115x73 mm
125x81 mm
150x96 mm

0,4897
0,5208
0,6740
1,0723
1,6086
2,6809
4,1018
7,2218
12,1277
27,0902

0,8082
0,9836
1,5585
2,2454
3,2777
5,6860
9,3806
13,4925
19,4685
35,0080

1,1082
1,1458
1,4828
2,3591
3,5389
6,0407

1,6543
1,6086
2,3672
3,5322
5,2080
9,0459

240
162
90
48
30
18
15
8
6
4

2.880
1.944
1.080
576
360
216
180
96
72
48

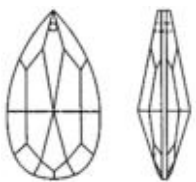

B.4310

38x20 mm
50x27 mm
63x33 mm
76x40 mm
89x47 mm
100x53 mm
115x60 mm
125x67 mm
150x79 mm

0,4734
0,6112
0,9804
1,4554
2,4510
3,7800
7,0291
11,0151
25,2764

0,9584
1,3362
2,0308
3,1244
5,0413
7,1569
12,3093
18,3562
33,1942

1,0414
1,3446
2,1569
3,2019
5,5229

1,4801
2,0697
3,2072
4,8709
8,1132

162
90
48
30
18
15
8
6
4

1.944
1.080
576
360
216
180
96
72
48



B.4320

38x19 mm
50x25 mm
63x31 mm
76x38 mm
89x44 mm
100x50 mm
115x57 mm
125x63 mm
150x75 mm

0,5836
0,7295
1,0942
1,6851
2,7720
4,2893
7,4386
13,3057
29,7362

1,0221
1,4545
2,1446
3,3541
5,4086
7,6686
12,6798
20,4108
37,6540

1,2839
1,6049
2,4073
3,7072
6,2462

1,7224
2,3299
3,4576
5,3763
8,8828

162
90
48
30
18
15
8
6
4

1.944
1.080
576
360
216
180
96
72
48

| CRYSTAL | CRYSTAL coated | COLOR | COLOR coated | minimum quantity | |
|---------------|--|---|--|---------------------|------------------|
| CLEAR | AB AFLAME AMBER ANTIQUÉ GOLD SILVER | ALEXANDRITE AMETHYST AQUAMARINE EMERALD JET ROSA LIN RUBY SAPPHIRE SMOKE TOPAZ | AB AFLAME AMBER ANTIQUÉ GOLD SILVER | | |
| | BB BW OG OS VL VM | | BB BW OG OS VL VM | | |
| EURO piece | EURO piece | EURO piece | EURO piece | BOX pieces | CARTON pieces |

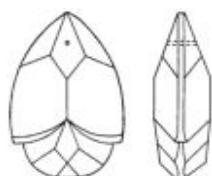

B.4004
50x29 mm

| | | | | | |
|--------|--------|--------|--------|----|-------|
| 0,9290 | 1,6539 | 2,0436 | 2,7685 | 90 | 1.080 |
|--------|--------|--------|--------|----|-------|

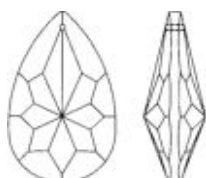

B.4003
50x29 mm
63x37 mm

| | | | | | |
|--------|--------|--------|--------|----|-------|
| 0,8445 | 1,5694 | 1,8578 | 2,5827 | 90 | 1.080 |
| 1,3173 | 2,4811 | 2,8982 | 4,0620 | 48 | 576 |

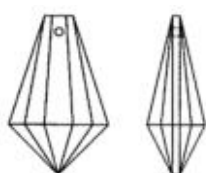

B.4012
50x25 mm
63x32 mm
76x38 mm

| | | | | | |
|--------|--------|--------|--------|----|-------|
| 0,7660 | 1,4594 | 1,6851 | 2,3786 | 90 | 1.080 |
| 1,1490 | 2,1993 | 2,5278 | 3,5782 | 60 | 720 |
| 1,7693 | 3,4384 | 3,8925 | 5,5616 | 40 | 480 |

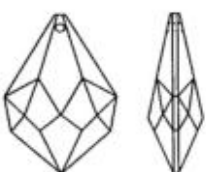

B.4040
50x29 mm
63x37 mm
76x44 mm

| | | | | | |
|--------|--------|--------|--------|----|-------|
| 0,6434 | 1,3682 | 1,4155 | 2,1402 | 90 | 1.080 |
| 1,0295 | 2,2876 | 2,2648 | 3,5229 | 48 | 576 |
| 1,5281 | 3,4316 | 3,3617 | 5,2653 | 30 | 360 |

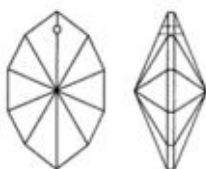

B.4116
38x23 mm
50x30 mm
63x38 mm
76x46 mm

| | | | | | |
|--------|--------|--------|--------|-----|-------|
| 0,5362 | 1,0175 | 1,1798 | 1,6611 | 162 | 1.944 |
| 0,7213 | 1,6331 | 1,5868 | 2,4987 | 90 | 1.080 |
| 1,1046 | 2,3510 | 2,4301 | 3,6765 | 48 | 576 |
| 1,6889 | 3,3995 | 3,7157 | 5,4263 | 30 | 360 |

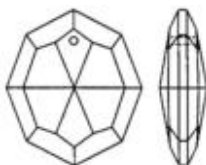

B.4122
63x50 mm
76x60 mm

| | | | | | |
|--------|--------|--------|--------|----|-----|
| 1,2401 | 2,7610 | 2,7283 | 4,2198 | 40 | 480 |
| 1,8966 | 4,0661 | 4,1726 | 6,3420 | 24 | 288 |

| CRYSTAL | CRYSTAL <u>coated</u> | COLOR | COLOR <u>coated</u> | minimum quantity | |
|---------------|--|---|--|---------------------|------------------|
| CLEAR | AB AFLAME AMBER ANTIQUÉ GOLD SILVER | ALEXANDRITE AMETHYST AQUAMARINE EMERALD JET ROSA LIN RUBY SAPPHIRE SMOKE TOPAZ | AB AFLAME AMBER ANTIQUÉ GOLD SILVER | | |
| | BB BW OG OS VL VM | | BB BW OG OS VL VM | | |
| EURO piece | EURO piece | EURO piece | EURO piece | BOX pieces | CARTON pieces |

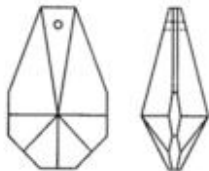

B.4125

38x24 mm
50x30 mm

0,5515
0,7353

1,0143
1,6206

1,2133
1,6177

1,6761
2,3674

162
90

1.944
1.080

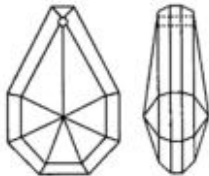

B.4126

50x26 mm
63x33 mm
76x40 mm
89x47 mm
100x53 mm
115x60 mm
125x67 mm

0,8024
1,2255
1,8383
3,0638
4,6724
7,5203
13,9264

1,4959
2,2759
3,4731
5,9293
9,9475
13,8484
21,2675

1,7653
2,6962
4,0442
7,2489

2,4588
3,7465
5,6791
10,1144

90
48
24
15
12
9
6

1.080
576
288
180
144
108
72

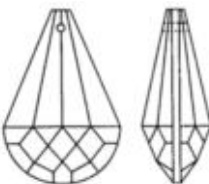

B.4127

50x30 mm
63x38 mm
76x46 mm
89x53 mm
100x60 mm
115x68 mm
125x76 mm

0,7660
1,2255
1,7356
3,0638
4,5957
8,3413
13,9020

1,6504
2,3886
3,4119
5,9879
9,8708
14,6694
21,4612

1,6851
2,6962
3,8184
6,7404

2,5695
3,8592
5,4947
9,6645

90
48
30
18
15
8
6

1.080
576
360
216
180
96
72



B.4138

63x37 mm
76x44 mm
89x52 mm
100x58 mm

1,2868
1,7693
2,8149
4,1822

2,4506
3,4384
5,8199
9,3602

2,8309
3,8926
6,1927

3,9947
5,5617
9,1977

60
40
18
15

720
480
216
180

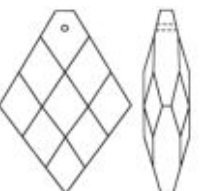

B.4139

63x40 mm
76x48 mm
89x57 mm

1,4477
2,0106
3,0561

2,6269
3,8890
6,1783

3,1848
4,4234
6,7235

4,3640
6,2417
9,8457

75
50
20

900
600
240

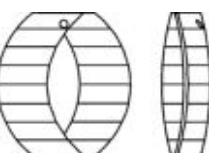

B.4149

50x44 mm

3,5074

5,0374

60

720

| CRYSTAL | CRYSTAL <u>coated</u> | C O L O R | C O L O R <u>coated</u> | minimum quantity | |
|---------------|--|---|--|---------------------|------------------|
| CLEAR | AB AFLAME AMBER ANTIQUÉ GOLD SILVER | ALEXANDRITE AMETHYST AQUAMARINE EMERALD JET ROSA LIN RUBY SAPPHIRE SMOKE TOPAZ | AB AFLAME AMBER ANTIQUÉ GOLD SILVER | | |
| | BB BW OG OS VL VM | | BB BW OG OS VL VM | | |
| EURO piece | EURO piece | EURO piece | EURO piece | BOX pieces | CARTON pieces |

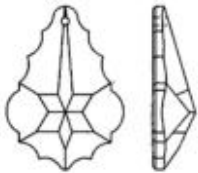

B.4108

38x26 mm
50x34 mm
63x43 mm
76x52 mm
89x60 mm
100x68 mm
115x77 mm
125x86 mm
150x102 mm

| | | | | | |
|---------|---------|--------|---------|-----|-------|
| 0,3704 | 0,8837 | 0,8150 | 1,3283 | 189 | 2.268 |
| 0,5796 | 1,4640 | 1,2751 | 2,1595 | 108 | 1.296 |
| 0,8389 | 2,0229 | 1,8456 | 3,0296 | 60 | 720 |
| 1,3727 | 3,2513 | 3,0200 | 4,8986 | 40 | 480 |
| 2,0790 | 5,2013 | 4,5738 | 7,6961 | 24 | 288 |
| 3,1186 | 7,5921 | 6,8609 | 12,1397 | 20 | 240 |
| 4,4982 | 11,2864 | | | 12 | 144 |
| 8,0773 | 15,7973 | | | 9 | 108 |
| 19,2184 | 32,4104 | | | 6 | 72 |

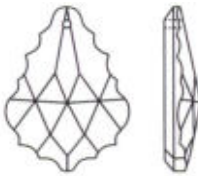

B.4208

50x34 mm
63x43 mm
76x52 mm
89x60 mm

| | | | | | |
|--------|--------|--------|--------|-----|-------|
| 0,5796 | 1,4640 | 1,2751 | 2,1595 | 108 | 1.296 |
| 0,8389 | 2,0229 | 1,8456 | 3,0296 | 60 | 720 |
| 1,3727 | 3,2513 | 3,0200 | 4,8986 | 40 | 480 |
| 2,0790 | 5,2013 | 4,5738 | 7,6961 | 24 | 288 |

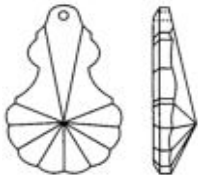

B.4109

50x32 mm
63x40 mm
76x49 mm

| | | | | | |
|--------|--------|--------|--------|-----|-------|
| 0,6128 | 1,4972 | 1,3481 | 2,2325 | 108 | 1.296 |
| 0,9191 | 2,0991 | 2,0221 | 3,2021 | 72 | 864 |
| 1,3787 | 3,2567 | 3,0332 | 4,9112 | 40 | 480 |

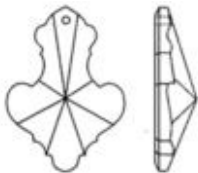

B.4110

50x33 mm
63x42 mm
76x50 mm
89x59 mm
100x66 mm

| | | | | | |
|--------|--------|--------|---------|-----|-------|
| 0,6128 | 1,4972 | 1,3481 | 2,2325 | 108 | 1.296 |
| 0,9191 | 2,0991 | 2,0221 | 3,2021 | 72 | 864 |
| 1,4415 | 3,3195 | 3,1712 | 5,0493 | 50 | 600 |
| 2,2979 | 5,4201 | 5,0553 | 8,1775 | 30 | 360 |
| 3,4469 | 7,6519 | 7,5831 | 11,7882 | 20 | 240 |

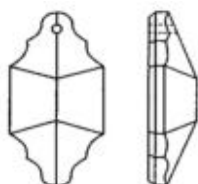

B.4111

50x25 mm
63x30 mm
76x36 mm

| | | | | | |
|--------|--------|--------|--------|-----|-------|
| 0,5662 | 1,2595 | 1,2457 | 1,9390 | 108 | 1.296 |
| 0,8409 | 2,0950 | 1,8500 | 3,1041 | 72 | 864 |
| 1,2612 | 2,6269 | 2,7747 | 4,1404 | 50 | 600 |

B.4211 (2-holes)

50x25 mm
63x30 mm
76x36 mm

| | | | | | |
|--------|--------|--------|--------|-----|-------|
| 0,5662 | 1,2595 | 1,2457 | 1,9390 | 108 | 1.296 |
| 0,8409 | 2,0950 | 1,8500 | 3,1041 | 72 | 864 |
| 1,2612 | 2,6269 | 2,7747 | 4,1404 | 50 | 600 |

| CRYSTAL | CRYSTAL <u>coated</u> | COLOR | COLOR <u>coated</u> | minimum quantity | |
|---------------|--|---|--|---------------------|------------------|
| CLEAR | AB AFLAME AMBER ANTIQUÉ GOLD SILVER | ALEXANDRITE AMETHYST AQUAMARINE EMERALD JET ROSA LIN RUBY SAPPHIRE SMOKE TOPAZ | AB AFLAME AMBER ANTIQUÉ GOLD SILVER | | |
| | BB BW OG OS VL VM | | BB BW OG OS VL VM | | |
| EURO piece | EURO piece | EURO piece | EURO piece | BOX pieces | CARTON pieces |

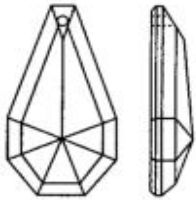

B.4463

50x26 mm
63x33 mm
76x40 mm
89x47 mm
100x53 mm
115x60 mm
125x67 mm

| | | | | | |
|--------|---------|--------|---------|-----|-------|
| 0,6740 | 1,3674 | 1,4828 | 2,1762 | 140 | 1.680 |
| 1,0111 | 2,0614 | 2,2244 | 3,2747 | 84 | 1.008 |
| 1,5319 | 3,1667 | 3,3702 | 5,0050 | 36 | 432 |
| 2,2979 | 5,1634 | 5,0553 | 7,9208 | 25 | 300 |
| 3,4469 | 8,7257 | 7,5831 | 12,8620 | 16 | 192 |
| 5,5149 | 12,3031 | | | 12 | 144 |
| 9,3446 | 16,9038 | | | 8 | 96 |

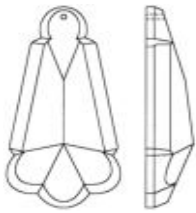

B.4464

50x23 mm
63x29 mm
76x35 mm
89x41 mm
100x46 mm
115x52 mm
125x58 mm

| | | | | | |
|--------|---------|--------|---------|-----|-------|
| 0,5393 | 1,2326 | 1,1864 | 1,8797 | 108 | 1.296 |
| 0,7660 | 1,8163 | 1,6851 | 2,7354 | 72 | 864 |
| 1,1030 | 2,7378 | 2,4265 | 4,0613 | 50 | 600 |
| 1,6545 | 4,5200 | 3,6398 | 6,5053 | 24 | 288 |
| 2,4817 | 7,7605 | 5,4597 | 10,7385 | 20 | 240 |
| 3,7378 | 10,2095 | | | 12 | 144 |
| 6,6945 | 14,0355 | | | 9 | 108 |

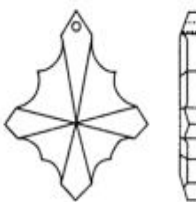

B.4465

50x40 mm
63x50 mm
76x60 mm

| | | | | | |
|--------|--------|--------|--------|-----|-------|
| 0,7431 | 1,6276 | 1,6348 | 2,5192 | 105 | 1.260 |
| 0,9191 | 2,4400 | 2,0221 | 3,5430 | 72 | 864 |
| 1,3787 | 3,2676 | 3,0332 | 4,9220 | 50 | 600 |

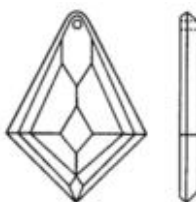

B.4470

50x30 mm
63x38 mm
76x46 mm
89x53 mm
100x60 mm
115x68 mm
125x76 mm
150x90 mm
175x107 mm
200x120 mm

| | | | | | |
|---------|---------|--------|---------|-----|-------|
| 0,7077 | 1,5921 | 1,5570 | 2,4414 | 108 | 1.296 |
| 1,0616 | 2,3197 | 2,3355 | 3,5936 | 60 | 720 |
| 1,6086 | 3,4734 | 3,5389 | 5,4038 | 40 | 480 |
| 2,4127 | 5,5081 | 5,3080 | 8,4033 | 24 | 288 |
| 3,6191 | 8,9395 | 7,9621 | 13,2824 | 20 | 240 |
| 5,5149 | 11,9013 | | | 12 | 144 |
| 9,3446 | 16,9038 | | | 9 | 108 |
| 15,9388 | 23,8566 | | | 6 | 72 |
| 27,2958 | 38,9363 | | | 4 | 48 |
| 49,0210 | 63,4389 | | | 4 | 48 |

| CRYSTAL | CRYSTAL <u>coated</u> | COLOR | COLOR <u>coated</u> | minimum quantity | |
|---------------|--|---|--|---------------------|------------------|
| CLEAR | AB AFLAME AMBER ANTIQUÉ GOLD SILVER | ALEXANDRITE AMETHYST AQUAMARINE EMERALD JET ROSA LIN RUBY SAPPHIRE SMOKE TOPAZ | AB AFLAME AMBER ANTIQUÉ GOLD SILVER | | |
| | BB BW OG OS VL VM | | BB BW OG OS VL VM | | |
| EURO piece | EURO piece | EURO piece | EURO piece | BOX pieces | CARTON pieces |

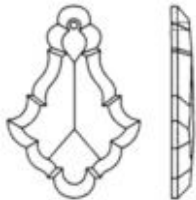

B.4400

| | | | | | | |
|------------|---------|---------|--------|---------|-----|-------|
| 50x33 mm | 0,6067 | 1,4911 | 1,3347 | 2,2191 | 126 | 1.512 |
| 63x42 mm | 0,8852 | 2,0652 | 1,9474 | 3,1274 | 84 | 1.008 |
| 76x50 mm | 1,2255 | 3,1036 | 2,6962 | 4,5742 | 70 | 840 |
| 89x59 mm | 1,8383 | 4,9605 | 4,0442 | 7,1664 | 36 | 432 |
| 100x66 mm | 2,7574 | 6,9625 | 6,0663 | 10,2714 | 30 | 360 |
| 115x75 mm | 4,1361 | 10,9243 | | | 20 | 240 |
| 125x84 mm | 6,5872 | 14,1464 | | | 15 | 180 |
| 150x99 mm | 10,7763 | 20,3607 | | | 10 | 120 |
| 175x117 mm | 18,2436 | 32,1208 | | | 4 | 48 |
| 200x132 mm | 32,7967 | 50,6225 | | | 4 | 48 |

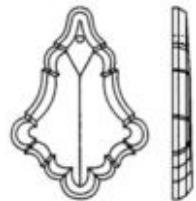

B.4405

| | | | | | | |
|------------|---------|---------|--------|---------|-----|-------|
| 50x35 mm | 0,6403 | 1,5248 | 1,4088 | 2,2932 | 108 | 1.296 |
| 63x44 mm | 0,9507 | 2,1307 | 2,0916 | 3,2716 | 80 | 960 |
| 76x53 mm | 1,3174 | 3,1955 | 2,8984 | 4,7764 | 42 | 504 |
| 89x62 mm | 1,9608 | 5,0830 | 4,3139 | 7,4361 | 35 | 420 |
| 100x70 mm | 2,9413 | 7,1463 | 6,4707 | 10,6758 | 24 | 288 |
| 115x80 mm | 4,4119 | 11,2001 | | | 15 | 180 |
| 125x89 mm | 7,0468 | 14,6059 | | | 8 | 96 |
| 150x105 mm | 11,5144 | 19,4321 | | | 6 | 72 |
| 175x125 mm | 22,5190 | 34,1596 | | | 4 | 48 |
| 200x140 mm | 40,6512 | 57,6906 | | | 4 | 48 |

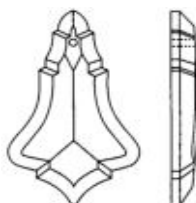

B.4410

| | | | | | | |
|------------|---------|---------|--------|--------|-----|-------|
| 50x30 mm | 0,5730 | 1,4574 | 1,2605 | 2,1450 | 126 | 1.512 |
| 63x38 mm | 0,8195 | 1,9995 | 1,8030 | 2,9830 | 96 | 1.152 |
| 76x46 mm | 1,1490 | 3,0270 | 2,5278 | 4,4059 | 70 | 840 |
| 89x53 mm | 1,6851 | 4,8073 | 3,7072 | 6,8294 | 36 | 432 |
| 100x60 mm | 2,5277 | 6,7328 | 5,5610 | 9,7661 | 30 | 360 |
| 115x68 mm | 3,8298 | 10,6180 | | | 20 | 240 |
| 125x76 mm | 6,1276 | 13,6868 | | | 15 | 180 |
| 150x90 mm | 10,0382 | 19,6226 | | | 10 | 120 |
| 175x107 mm | 17,0599 | 30,9370 | | | 4 | 48 |
| 200x120 mm | 30,6381 | 48,4639 | | | 4 | 48 |

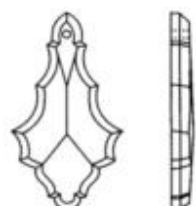

B.4420

| | | | | | | |
|------------|---------|---------|--------|---------|-----|-------|
| 50x25 mm | 0,5393 | 1,2326 | 1,1864 | 1,8797 | 162 | 1.944 |
| 63x31 mm | 0,7660 | 1,9133 | 1,6851 | 2,8325 | 96 | 1.152 |
| 76x38 mm | 1,1030 | 2,7720 | 2,4265 | 4,0955 | 70 | 840 |
| 89x44 mm | 1,6545 | 4,5320 | 3,6398 | 6,5174 | 42 | 504 |
| 100x50 mm | 2,4817 | 7,7605 | 5,4597 | 10,7385 | 35 | 420 |
| 115x57 mm | 3,7378 | 10,2095 | | | 24 | 288 |
| 125x63 mm | 5,9744 | 13,3155 | | | 18 | 216 |
| 150x75 mm | 10,0382 | 17,9559 | | | 10 | 120 |
| 175x89 mm | 16,7117 | 28,3522 | | | 6 | 72 |
| 200x100 mm | 30,0811 | 44,4990 | | | 4 | 48 |

| CRYSTAL | CRYSTAL <u>coated</u> | C O L O R | C O L O R <u>coated</u> | minimum quantity | |
|---------------|--|--|--|---------------------|------------------|
| CLEAR | AB AFLAME AMBER ANTIQUÉ GOLD SILVER | ALEXANDRITE AMETHYST AQUAMARINE EMERALD JET ROSALIN RUBY SAPPHIRE SMOKE TOPAZ | AB AFLAME AMBER ANTIQUÉ GOLD SILVER | | |
| | BB BW OG OS VL VM | | BB BW OG OS VL VM | | |
| EURO piece | EURO piece | EURO piece | EURO piece | BOX pieces | CARTON pieces |

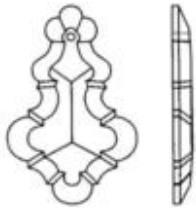

B.4440

| | | | | | | |
|------------|---------|---------|--------|--------|-----|-------|
| 50x30 mm | 0,5730 | 1,4574 | 1,2605 | 2,1450 | 126 | 1.512 |
| 63x38 mm | 0,8195 | 1,9995 | 1,8030 | 2,9830 | 84 | 1.008 |
| 76x46 mm | 1,1490 | 3,0270 | 2,5278 | 4,4059 | 70 | 840 |
| 89x53 mm | 1,6851 | 4,8073 | 3,7072 | 6,8294 | 42 | 504 |
| 100x60 mm | 2,5277 | 6,7328 | 5,5610 | 9,7661 | 35 | 420 |
| 115x68 mm | 3,8298 | 10,6180 | | | 24 | 288 |
| 125x76 mm | 6,1276 | 13,6868 | | | 15 | 180 |
| 150x90 mm | 10,0382 | 19,6226 | | | 10 | 120 |
| 175x107 mm | 17,0599 | 30,9370 | | | 4 | 48 |
| 200x120 mm | 30,6381 | 48,4639 | | | 4 | 48 |

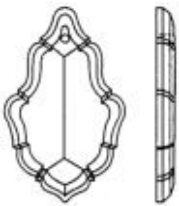

B.4433

| | | | | | | |
|------------|---------|---------|--------|---------|-----|-------|
| 50x30 mm | 0,6403 | 1,5248 | 1,4088 | 2,2932 | 126 | 1.512 |
| 63x38 mm | 0,9507 | 2,1307 | 2,0916 | 3,2716 | 84 | 1.008 |
| 76x46 mm | 1,4491 | 3,3272 | 3,1882 | 5,0662 | 70 | 840 |
| 89x53 mm | 1,9608 | 5,0830 | 4,3139 | 7,4361 | 42 | 504 |
| 100x60 mm | 2,9413 | 7,1463 | 6,4707 | 10,6758 | 30 | 360 |
| 115x68 mm | 4,4119 | 11,2001 | | | 24 | 288 |
| 125x76 mm | 7,0468 | 14,6059 | | | 15 | 180 |
| 150x90 mm | 11,5144 | 19,4321 | | | 10 | 120 |
| 175x105 mm | 22,5190 | 34,1596 | | | 4 | 48 |
| 200x118 mm | 40,6512 | 57,6906 | | | 4 | 48 |

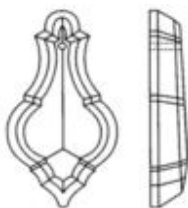

B.4445

| | | | | | | |
|-----------|--------|---------|--------|---------|-----|-------|
| 50x25 mm | 0,6403 | 1,5248 | 1,4088 | 2,2932 | 108 | 1.296 |
| 63x31 mm | 0,9507 | 2,1307 | 2,0916 | 3,2716 | 72 | 864 |
| 76x38 mm | 1,3174 | 3,1955 | 2,8984 | 4,7764 | 50 | 600 |
| 89x44 mm | 1,9608 | 5,0830 | 4,3139 | 7,4361 | 30 | 360 |
| 100x50 mm | 2,9413 | 7,1463 | 6,4707 | 10,6758 | 25 | 300 |
| 115x57 mm | 4,4119 | 11,2001 | | | 16 | 192 |
| 125x63 mm | 7,0468 | 14,6059 | | | 12 | 144 |



B.4444

| | | | | | | |
|-----------|--------|---------|--------|---------|-----|-------|
| 50x30 mm | 0,6067 | 1,4911 | 1,3347 | 2,2191 | 126 | 1.512 |
| 63x37 mm | 0,8852 | 2,0652 | 1,9474 | 3,1274 | 84 | 1.008 |
| 76x45 mm | 1,2255 | 3,1036 | 2,6962 | 4,5742 | 70 | 840 |
| 89x53 mm | 1,8383 | 4,9605 | 4,0442 | 7,1664 | 42 | 504 |
| 100x59 mm | 2,8887 | 7,0938 | 6,3552 | 10,5603 | 30 | 360 |
| 115x67 mm | 4,3331 | 11,1213 | | | 20 | 240 |
| 125x75 mm | 6,9009 | 14,4600 | | | 12 | 144 |

| CRYSTAL | CRYSTAL <u>coated</u> | COLOR | COLOR <u>coated</u> | minimum quantity | |
|---------------|--|---|--|---------------------|------------------|
| CLEAR | AB AFLAME AMBER ANTIQUÉ GOLD SILVER | ALEXANDRITE AMETHYST AQUAMARINE EMERALD JET ROSA LIN RUBY SAPPHIRE SMOKE TOPAZ | AB AFLAME AMBER ANTIQUÉ GOLD SILVER | | |
| | BB BW OG OS VL VM | | BB BW OG OS VL VM | | |
| EURO piece | EURO piece | EURO piece | EURO piece | BOX pieces | CARTON pieces |



B.4430

| | | | | | | |
|------------|---------|---------|--------|---------|-----|-------|
| 50x33 mm | 0,6067 | 1,4911 | 1,3347 | 2,2191 | 126 | 1.512 |
| 63x42 mm | 0,8852 | 2,0652 | 1,9474 | 3,1274 | 84 | 1.008 |
| 76x50 mm | 1,2255 | 3,1036 | 2,6962 | 4,5742 | 70 | 840 |
| 89x59 mm | 1,8383 | 4,9605 | 4,0442 | 7,1664 | 36 | 432 |
| 100x66 mm | 2,7574 | 6,9625 | 6,0663 | 10,2714 | 30 | 360 |
| 115x75 mm | 4,1361 | 10,9243 | | | 20 | 240 |
| 125x84 mm | 6,5872 | 14,1464 | | | 15 | 180 |
| 150x99 mm | 10,7763 | 20,3607 | | | 10 | 120 |
| 175x117 mm | 22,5190 | 34,1596 | | | 4 | 48 |
| 200x132 mm | 40,6512 | 57,6906 | | | 4 | 48 |



B.4425

| | | | | | | |
|------------|---------|---------|--------|---------|-----|-------|
| 50x32 mm | 0,6403 | 1,5248 | 1,4088 | 2,2932 | 108 | 1.296 |
| 63x40 mm | 0,9507 | 2,1307 | 2,0916 | 3,2716 | 72 | 864 |
| 76x49 mm | 1,3174 | 3,1955 | 2,8984 | 4,7764 | 60 | 720 |
| 89x57 mm | 1,9608 | 5,0830 | 4,3139 | 7,4361 | 36 | 432 |
| 100x64 mm | 2,9413 | 7,1463 | 6,4707 | 10,6758 | 30 | 360 |
| 115x73 mm | 4,4119 | 11,2001 | | | 16 | 192 |
| 125x81 mm | 7,0468 | 14,6059 | | | 12 | 144 |
| 150x96 mm | 11,5144 | 19,4321 | | | 8 | 96 |
| 175x114 mm | 22,5190 | 34,1596 | | | 4 | 48 |
| 200x128 mm | 40,6512 | 57,6906 | | | 4 | 48 |



B.4435

| | | | | | | |
|------------|---------|---------|--------|---------|-----|-------|
| 50x33 mm | 0,6067 | 1,4911 | 1,3347 | 2,2191 | 126 | 1.512 |
| 63x42 mm | 0,8852 | 2,0652 | 1,9474 | 3,1274 | 84 | 1.008 |
| 76x50 mm | 1,2255 | 3,1036 | 2,6962 | 4,5742 | 70 | 840 |
| 89x59 mm | 1,8383 | 4,9605 | 4,0442 | 7,1664 | 36 | 432 |
| 100x66 mm | 2,7574 | 6,9625 | 6,0663 | 10,2714 | 30 | 360 |
| 115x75 mm | 4,1361 | 10,9243 | | | 20 | 240 |
| 125x84 mm | 6,5872 | 14,1464 | | | 15 | 180 |
| 150x99 mm | 10,7763 | 20,3607 | | | 10 | 120 |
| 175x117 mm | 22,5190 | 34,1596 | | | 4 | 48 |
| 200x132 mm | 40,6512 | 57,6906 | | | 4 | 48 |



B.4434

| | | | | | | |
|------------|---------|---------|--------|---------|-----|-------|
| 50x33 mm | 0,6403 | 1,5248 | 1,4088 | 2,2932 | 108 | 1.296 |
| 63x42 mm | 0,9507 | 2,1307 | 2,0916 | 3,2716 | 72 | 864 |
| 76x50 mm | 1,4491 | 3,3272 | 3,1882 | 5,0662 | 60 | 720 |
| 89x59 mm | 1,9608 | 5,0830 | 4,3139 | 7,4361 | 36 | 432 |
| 100x66 mm | 2,9413 | 7,1463 | 6,4707 | 10,6758 | 25 | 300 |
| 115x75 mm | 4,4119 | 11,2001 | | | 20 | 240 |
| 125x84 mm | 7,0468 | 14,6059 | | | 12 | 144 |
| 150x99 mm | 11,5144 | 19,4321 | | | 8 | 96 |
| 175x117 mm | 22,5190 | 34,1596 | | | 4 | 48 |
| 200x132 mm | 40,6512 | 57,6906 | | | 4 | 48 |

| CRYSTAL | CRYSTAL <u>coated</u> | COLOR | COLOR <u>coated</u> | minimum quantity | |
|---------------|--|---|--|---------------------|------------------|
| CLEAR | AB AFLAME AMBER ANTIQUÉ GOLD SILVER | ALEXANDRITE AMETHYST AQUAMARINE EMERALD JET ROSA LIN RUBY SAPPHIRE SMOKE TOPAZ | AB AFLAME AMBER ANTIQUÉ GOLD SILVER | | |
| | BB BW OG OS VL VM | | BB BW OG OS VL VM | | |
| EURO piece | EURO piece | EURO piece | EURO piece | BOX pieces | CARTON pieces |



B.4450

50x32 mm
63x40 mm
76x49 mm
89x57 mm
100x64 mm
115x73 mm
125x81 mm
150x96 mm
175x114 mm
200x128 mm

0,6403
0,9507
1,3174
1,9608
2,9413
4,4119
7,0468
11,5144
22,5190
40,6512

1,5248
2,1307
3,1955
5,0830
7,1463
11,2001
14,6059
19,4321
34,1596
57,6906

1,4088
2,0916
2,8984
4,3139
6,4707

2,2932
3,2716
4,7764
7,4361
10,6758

108 1.296
72 864
50 600
36 432
25 300
16 192
12 144
8 96
4 48
4 48



B.4460

50x25 mm
63x31 mm
76x38 mm
89x44 mm
100x50 mm
115x57 mm
125x63 mm
150x75 mm
175x89 mm
200x100 mm

0,5393
0,7660
1,1030
1,6545
2,4817
3,7378
5,9744
10,0382
16,7117
30,0811

1,2326
1,9133
2,7720
4,5320
7,7605
10,2095
13,3155
17,9559
28,3522
44,4990

1,1864
1,6851
2,4265
3,6398
5,4597

1,8797
2,8325
4,0955
6,5174
10,7385

126 1.512
84 1.008
70 840
36 432
30 360
20 240
15 180
10 120
4 48
4 48



B.4480

100x60 mm
125x75 mm
150x90 mm

4,8256
7,7208
12,3533

10,1459
15,2800
20,2710

30 360
15 180
10 120

| CRYSTAL | CRYSTAL coated | C O L O R | C O L O R coated | minimum quantity | |
|---------------|--|---|--|---------------------|------------------|
| CLEAR | AB AFLAME AMBER ANTIQUÉ GOLD SILVER | ALEXANDRITE AMETHYST AQUAMARINE EMERALD JET ROSA LIN RUBY SAPPHIRE SMOKE TOPAZ | AB AFLAME AMBER ANTIQUÉ GOLD SILVER | | |
| | BB BW OG OS VL VM | | BB BW OG OS VL VM | | |
| EURO piece | EURO piece | EURO piece | EURO piece | BOX pieces | CARTON pieces |



B.4705

15x3 mm CH: 2,0mm
25x3 mm CH: 2,0mm

0,7092
0,7092

0,8531
1,1120

1,5602
1,5602

1,7902
1,9630

1.200
450

14.400
5.400

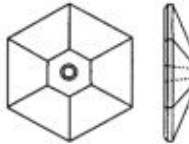

B.4710

20x5 mm CH: 2,5mm
25x6 mm CH: 3,5mm
30x7 mm CH: 4,0mm
35x8 mm CH: 4,5mm
40x9 mm CH: 5,0mm

0,6942
0,6942
0,6942
0,7361
0,7660

0,9240
1,0351
1,1487
1,3039
1,4946

1,5274
1,5274
1,5274
2,2282
2,4073

1,7572
1,8683
2,0692
2,8359
3,4482

480
270
160
140
70

5.760
3.240
1.920
1.680
840

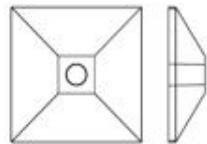

B.4730

90x24 mm CH: 13mm

6,4340

12,6941

14,1548

20,4149

8

96

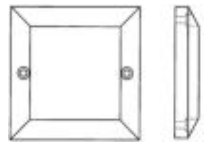

B.4740

50x9 mm SH: 4/2mm

3,8888

5,1989

8,5552

9,8653

50

600

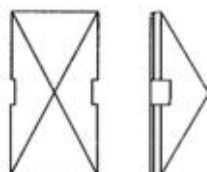

B.4750

50x30 mm
63x30 mm

0,6194
0,8426

1,5177
1,7409

1,3627
1,8538

2,2348
2,7259

72
70

864
840

| CRYSTAL | CRYSTAL <u>coated</u> | COLOR | COLOR <u>coated</u> | minimum quantity | |
|---------------|--|---|--|---------------------|------------------|
| CLEAR | AB AFLAME AMBER ANTIQUÉ GOLD SILVER | ALEXANDRITE AMETHYST AQUAMARINE EMERALD JET ROSA LIN RUBY SAPPHIRE SMOKE TOPAZ | AB AFLAME AMBER ANTIQUÉ GOLD SILVER | | |
| EURO piece | EURO piece | EURO piece | EURO piece | BOX pieces | CARTON pieces |

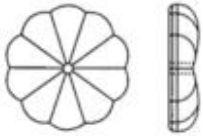

B.4700

| | | | | | | |
|-----------------|--------|--------|---------|---------|-----|-------|
| 20 mm CH: 2,5mm | 0,2471 | 0,4833 | 0,5437 | 0,7798 | 384 | 4.608 |
| 25 mm CH: 2,5mm | 0,2647 | 0,6675 | 0,5824 | 0,9852 | 270 | 3.240 |
| 30 mm CH: 2,5mm | 0,3218 | 0,9190 | 0,7079 | 1,3051 | 216 | 2.592 |
| 35 mm CH: 3,0mm | 0,3983 | 1,0428 | 0,8763 | 1,5208 | 140 | 1.680 |
| 40 mm CH: 3,5mm | 0,5056 | 1,2342 | 1,1123 | 1,8409 | 140 | 1.680 |
| 50 mm CH: 4,0mm | 0,7660 | 2,0622 | 1,6851 | 2,9814 | 70 | 840 |
| 60 mm CH: 4,5mm | 1,3022 | 3,0034 | 2,8649 | 4,5661 | 36 | 432 |
| 70 mm CH: 5,0mm | 2,8341 | 5,7553 | 6,2351 | 9,1563 | 25 | 300 |
| 80 mm CH: 5,5mm | 4,5957 | 8,8720 | 10,1106 | 14,3869 | 16 | 192 |

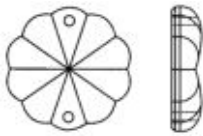

B.4702

| | | | | | | |
|-------|--------|--------|--------|--------|-----|-------|
| 20 mm | 0,2471 | 0,4833 | 0,5437 | 0,7798 | 384 | 4.608 |
| 25 mm | 0,2647 | 0,6675 | 0,5824 | 0,9852 | 270 | 3.240 |
| 30 mm | 0,3218 | 0,9190 | 0,7079 | 1,3051 | 216 | 2.592 |
| 35 mm | 0,3983 | 1,0428 | 0,8763 | 1,5208 | 140 | 1.680 |
| 40 mm | 0,5056 | 1,2342 | 1,1123 | 1,8409 | 140 | 1.680 |



B.4715

| | | | | | | |
|-----------------|--------|--------|---------|---------|-----|-------|
| 20 mm CH: 2,5mm | 0,2471 | 0,4833 | 0,5437 | 0,7798 | 384 | 4.608 |
| 25 mm CH: 2,5mm | 0,2647 | 0,6675 | 0,5824 | 0,9852 | 270 | 3.240 |
| 30 mm CH: 2,5mm | 0,3218 | 0,9190 | 0,7079 | 1,3051 | 216 | 2.592 |
| 35 mm CH: 3,0mm | 0,3983 | 1,0428 | 0,8763 | 1,5208 | 140 | 1.680 |
| 40 mm CH: 3,5mm | 0,5056 | 1,2342 | 1,1123 | 1,8409 | 140 | 1.680 |
| 50 mm CH: 4,0mm | 0,7660 | 2,0622 | 1,6851 | 2,9814 | 70 | 840 |
| 60 mm CH: 4,5mm | 1,3022 | 3,0034 | 2,8649 | 4,5661 | 36 | 432 |
| 70 mm CH: 5,0mm | 2,8341 | 5,7553 | 6,2351 | 9,1563 | 25 | 300 |
| 80 mm CH: 5,5mm | 4,5957 | 8,8720 | 10,1106 | 14,3869 | 16 | 192 |



B.4717

| | | | | | | |
|-------|--------|--------|--------|--------|-----|-------|
| 20 mm | 0,2471 | 0,4833 | 0,5437 | 0,7798 | 384 | 4.608 |
| 25 mm | 0,2647 | 0,6675 | 0,5824 | 0,9852 | 270 | 3.240 |
| 30 mm | 0,3218 | 0,9190 | 0,7079 | 1,3051 | 216 | 2.592 |
| 35 mm | 0,3983 | 1,0428 | 0,8763 | 1,5208 | 140 | 1.680 |
| 40 mm | 0,5056 | 1,2342 | 1,1123 | 1,8409 | 140 | 1.680 |

| CRYSTAL | CRYSTAL <u>coated</u> | COLOR | COLOR <u>coated</u> | minimum quantity | |
|---------------|--|---|--|---------------------|------------------|
| CLEAR | AB AFLAME AMBER ANTIQUÉ GOLD SILVER | ALEXANDRITE AMETHYST AQUAMARINE EMERALD JET ROSA LIN RUBY SAPPHIRE SMOKE TOPAZ | AB AFLAME AMBER ANTIQUÉ GOLD SILVER | | |
| | BB BW OG OS VL VM | | BB BW OG OS VL VM | | |
| EURO piece | EURO piece | EURO piece | EURO piece | BOX pieces | CARTON pieces |



B.4900

36x50 mm CH: 13mm
40x63 mm CH: 13mm
44x76 mm CH: 13mm

4,6363
7,7270
10,2601

10,1997
16,9995
22,0211

24 288
20 240
6 72



B.4910

30x10 mm CH: 13mm
40x12 mm CH: 13mm
50x16 mm CH: 13mm
60x20 mm CH: 13mm

1,3648
1,9218
2,8828
4,3242

3,0025
4,2281
6,3421
9,5133

162 1.944
80 960
40 480
24 288



B.4920

30x8 mm CH: 13mm
40x11 mm CH: 13mm
50x14 mm CH: 13mm
60x16 mm CH: 13mm

1,0067
1,6778
2,6845
4,2785

2,2147
3,6912
5,9059
9,4127

162 1.944
100 1.200
50 600
24 288

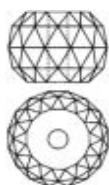

B.4930

30x22 mm CH: 13mm
40x32 mm CH: 13mm
50x42 mm CH: 13mm
60x52 mm CH: 13mm
70x62 mm CH: 13mm

2,1057
2,9106
5,7602
11,2395
26,7211

6,4061
8,4255
12,6725
25,0125

72 864
34 408
12 144
10 120
5 60

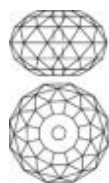

B.4935

75x50 mm CH: 13mm

19,8556

5 60



B.4940

40x40 mm CH: 13mm

4,1486

9,1268

34 408

| CRYSTAL | CRYSTAL coated | COLOR | COLOR coated | minimum quantity | |
|---------------|--|---|--|---------------------|------------------|
| CLEAR | AB AFLAME AMBER ANTIQUÉ GOLD SILVER | ALEXANDRITE AMETHYST AQUAMARINE EMERALD JET ROSA LIN RUBY SAPPHIRE SMOKE TOPAZ | AB AFLAME AMBER ANTIQUÉ GOLD SILVER | | |
| | BB BW OG OS VL VM | | BB BW OG OS VL VM | | |
| EURO piece | EURO piece | EURO piece | EURO piece | BOX pieces | CARTON pieces |



B.4800

80x9 mm CH: 13mm
90x10 mm CH: 13mm

5,3081
8,1958

15 180
15 180



drilling of extra SH :

0,3800

stud-insertion into SH :

BRASS 0,0900
CHROME-PLATED 0,1000
GOLD-PLATED 0,1200



B.4805

90x20 mm CH: 13mm

9,8042

12 144

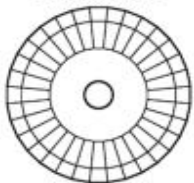

drilling of extra SH :

0,3800

stud-insertion into SH :

BRASS 0,0900
CHROME-PLATED 0,1000
GOLD-PLATED 0,1200



B.4830

90x15 mm CH: 13mm
4 SH

9,8042

15 180

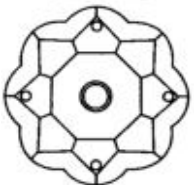

drilling of extra SH :

0,3800

stud-insertion into SH :

BRASS 0,0900
CHROME-PLATED 0,1000
GOLD-PLATED 0,1200



B.4810

90x14 mm CH: 13mm

9,8042

15 180

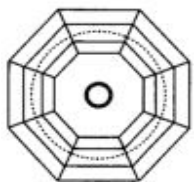

drilling of extra SH :

0,3800

stud-insertion into SH :

BRASS 0,0900
CHROME-PLATED 0,1000
GOLD-PLATED 0,1200



B.4820

90x13 mm CH: 13mm

9,8042

15 180

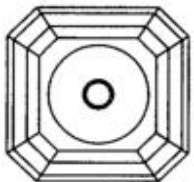

drilling of extra SH :

0,3800

stud-insertion into SH :

BRASS 0,0900
CHROME-PLATED 0,1000
GOLD-PLATED 0,1200



ASF0UR



ASF0UR

lead crystal

magnificent brilliance

machine-cut

made by Asfour

pinning service available

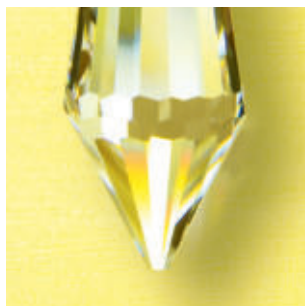
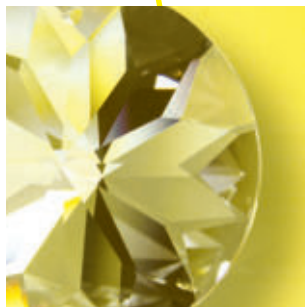

Schöler & Co. GmbH

Gablonzer Strasse 54-61
A-4550 Kremsmünster
Austria

T: ++43-75 83-77 23

F: ++43-75 83-78 12

E: office@scholer-crystal.at

W: www.scholer-crystal.at

















ARTICLE INDEX

| Article: | Page: | Article: | Page: |
|-----------------|--------------|-----------------|--------------|
| A.00TR | 16 | A.0701 | 17 |
| A.0001 | 28 | A.0710 | 25 |
| A.0002 | 28 | A.0730 | 17 |
| A.0003 | 28 | A.0740 | 17 |
| A.0004 | 28 | A.0870 | 19 |
| A.0005 | 28 | A.0872 | 18 |
| A.0021 | 28 | A.0873 | 18 |
| A.0022 | 28 | A.0874 | 18 |
| A.0023 | 28 | A.0877 | 18 |
| A.0100 | 25 | A.0902 | 21 |
| A.0101 | 27 | A.0906 | 21 |
| A.0102 | 26 | A.0907 | 21 |
| A.0103 | 26 | A.0908 | 21 |
| A.0104 | 26 | A.0910 | 20 |
| A.0105 | 27 | A.0911 | 20 |
| A.0106 | 27 | A.0913 | 21 |
| A.0107 | 27 | A.0914 | 21 |
| A.0201 | 22 | A.0915 | 20 |
| A.0202 | 22 | A.0916 | 20 |
| A.0203 | 22 | A.0917 | 20 |
| A.0204 | 22 | A.0918 | 19 |
| A.0205 | 22 | A.0919 | 19 |
| A.0206 | 22 | A.0921 | 20 |
| A.0207 | 23 | A.0922 | 19 |
| A.0208 | 23 | A.0925 | 19 |
| A.0209 | 23 | A.0929 | 19 |
| A.0210 | 23 | A.0973 | 18 |
| A.0211 | 23 | A.0990 | 18 |
| A.0401 | 15 | A.1006 | 10 |
| A.0405 | 15 | A.1020 | 10 |
| A.0424 | 15 | A.1032 | 9 |
| A.0432 | 15 | A.1036 | 24 |
| A.0485 | 15 | A.1037 | 24 |
| A.0502 | 16 | A.1038 | 24 |
| A.0504 | 16 | A.1039 | 10+25 |
| A.0505 | 16 | A.1040 | 10 |
| A.0508 | 16 | A.1041 | 10 |
| A.0600 | 11 | A.1050 | 9 |
| A.0601 | 11 | A.1080 | 9 |
| A.0604 | 14 | A.1081 | 9 |
| A.0605 | 14 | A.1082 | 9 |
| A.0606 | 14 | A.1083 | 9 |
| A.0610 | 11 | A.1084 | 9 |
| A.0611 | 11 | A.1088 | 10 |
| A.0612 | 14 | A.1160 | 10 |
| A.0614 | 14 | A.1502 | 17 |
| A.0616 | 14 | A.1503 | 17 |
| A.0618 | 14 | A.1504 | 17 |
| A.0630 | 16 | A.2020 | 11 |
| A.0640 | 12 | A.2024 | 11 |
| A.0641 | 12 | A.3040 | 21 |
| A.0650 | 13 | | |
| A.0651 | 13 | | |
| A.0660 | 13 | | |
| A.0661 | 13 | | |
| A.0670 | 12 | | |
| A.0671 | 12 | | |

PRODUCT GROUP

Page:

| | | |
|----------------------------------|---|---------|
| OCTAGONS |  | 9 - 10 |
| ROUNDS & ROSETTES |  | 10 |
| SQUARE STONES & RECTANGLE STONES |  | 11 - 13 |
| COFFIN STONES |  | 14 |
| ICICLES |  | 15 |
| POINTED STONES |  | 16 |
| BALLS |  | 17 |
| BEADS |  | 17 |
| ALMONDS |  | 18 |
| PENDELOQUES |  | 19 - 21 |
| CENTERPIECES (SOLID) |  | 25 |
| CENTERPIECES (HOLLOW) |  | 22 - 23 |
| BOBECHES (SOLID) |  | 24 - 25 |
| BOBECHES (HOLLOW) |  | 26 - 27 |
| ARMS |  | 28 |

LOGO

The ASF4UR logo is pressed on the top of the balls, pendeloques, drops etc. and is applied on many of the articles where technically possible.

It has been registered as part of the agreement of Madrid in many countries around the globe.

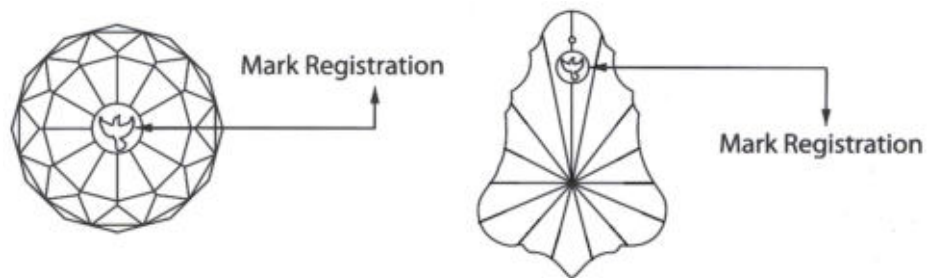



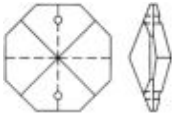
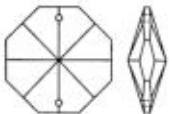
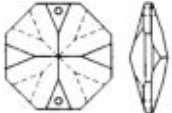
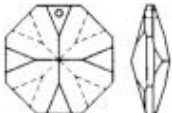
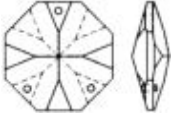
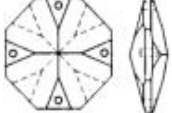
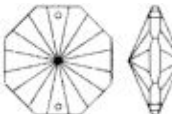

CHANDELIER LABEL

The ASF4UR label is to ensure the authenticity and originality of a chandelier which is dressed with ASF4UR lead crystal (30% PbO) components.

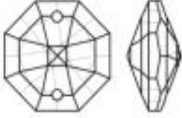
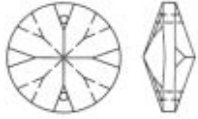
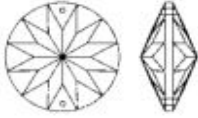
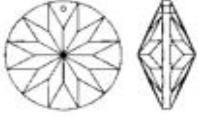
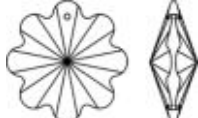

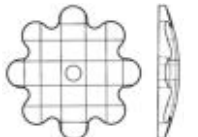
| | CRYSTAL | CRYSTAL coated | minimum quantity | | |
|---|--|--|--|--|---|
| | CLEAR | AB AFLAME AMBER ANTIQUÉ GOLD SILVER | | | |
| | | BB BW OG OS VL VM | | | |
| inch | EURO piece | EURO piece | BOX pieces | CARTON pieces | |
|  | A.1082 12 mm 14 mm | 0,0416 0,0542 | 0,1700 0,1831 | 2.132 2.000 | 12.792 12.000 |
|  | A.1050 14 mm | 0,0561 | 0,1849 | 2.000 | 12.000 |
|  | A.1080 12 mm 14 mm 16 mm 18 mm 20 mm 22 mm 24 mm 26 mm 28 mm 30 mm 32 mm 34 mm 36 mm 38 mm 40 mm 50 mm 60 mm | 0,0506 0,0579 0,1085 0,1519 0,2405 0,2640 0,3146 0,4141 0,4719 0,5533 0,7088 1,1120 1,3959 1,6002 1,9618 3,1117 5,2507 | 0,1790 0,1867 0,2584 0,3430 0,4805 0,5317 0,6299 0,7914 0,9113 1,0462 1,2429 1,7006 2,0372 2,3320 2,7943 4,4360 7,1569 | 2.132 2.000 1.188 960 585 520 368 308 308 180 162 144 120 120 85 48 40 | 12.792 12.000 7.128 5.760 3.510 3.120 2.208 1.848 1.848 1.080 972 864 720 720 510 288 240 |
|  | A.1081 14 mm | 0,0579 | 0,1867 | 2.000 | 12.000 |
|  | A.1083 16 mm | 0,1085 | 0,2584 | 1.188 | 7.128 |
|  | A.1084 18 mm 20 mm 22 mm 24 mm 26 mm 28 mm | 0,1519 0,2405 0,2640 0,3146 0,4141 0,4719 | 0,3430 0,4805 0,5317 0,6299 0,7914 0,9113 | 960 585 520 368 308 308 | 5.760 3.510 3.120 2.208 1.848 1.848 |
|  | A.1032 14 mm | 0,0868 | 0,2156 | 2.000 | 12.000 |

| | inch | CRYSTAL CLEAR | CRYSTAL coated AB AFLAME AMBER ANTIQUÉ GOLD SILVER BB BW OG OS VL VM | minimum quantity | |
|---|-----------------|------------------|---|---------------------|------------------|
| | | EURO piece | EURO piece | BOX pieces | CARTON pieces |
|  | A.1020 | | | | |
| | 12 mm | 0,0796 | 0,2079 | 2.132 | 12.792 |
| | 14 mm | 0,1035 | 0,2416 | 2.000 | 12.000 |
| | 16 mm | 0,2007 | 0,3507 | 1.188 | 7.128 |
| | 18 mm | 0,2784 | 0,4695 | 960 | 5.760 |
| | 20 mm | 0,4412 | 0,6812 | 585 | 3.510 |
| | 22 mm | 0,4864 | 0,7541 | 520 | 3.120 |
| | 24 mm | 0,5804 | 0,8957 | 368 | 2.208 |
| | 26 mm | 0,7648 | 1,1422 | 308 | 1.848 |
| | 28 mm | 0,8697 | 1,3091 | 308 | 1.848 |
| | 30 mm | 1,0180 | 1,5109 | 180 | 1.080 |
| | 32 mm | 1,3073 | 1,8414 | 162 | 972 |
| | 34 mm | 2,0486 | 2,6372 | 144 | 864 |
| | 36 mm | 2,5711 | 3,2125 | 120 | 720 |
| 38 mm | 2,9526 | 3,6845 | 120 | 720 | |
| 40 mm | 3,6090 | 4,4415 | 85 | 510 | |
| 50 mm | 5,7208 | 7,0450 | 48 | 288 | |
| 60 mm | 9,6625 | 11,5687 | 40 | 240 | |
|  | A.1088 | | | | |
| | 14 mm | 0,0470 | 0,1758 | 2.000 | 12.000 |
|  | A.1040 | | | | |
| | 40 mm | 1,0505 | 1,8825 | 85 | 510 |
| 45 mm | 1,7032 | 2,7825 | 68 | 408 | |
|  | A.1041 | | | | |
| | 40 mm | 1,2313 | 2,0633 | 85 | 510 |
| 45 mm | 1,9347 | 3,2837 | 68 | 408 | |
|  | A.1160 | | | | |
| 50 mm | 2,9128 | 4,6383 | 48 | 288 | |
|  | A.1006 | | | | |
| | 14 mm CH: 2,5mm | 0,0579 | 0,2636 | 1.750 | 10.500 |
| | 20 mm CH: 2,5mm | 0,0687 | 0,3263 | 715 | 4.290 |
| | 24 mm CH: 2,5mm | 0,0868 | 0,4017 | 728 | 4.368 |
| 30 mm CH: 2,5mm | 0,1356 | 0,7872 | 330 | 1.980 | |
|  | A.1039 | | | | |
| 80 mm CH: 5,0mm | 5,9389 | 10,6038 | 24 | 144 | |

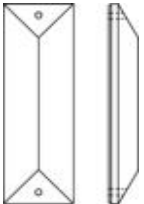
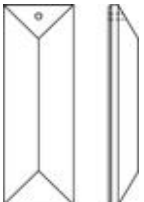
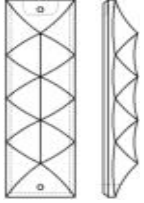
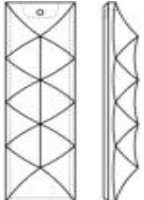
| | | CRYSTAL | CRYSTAL coated | minimum quantity | | |
|---|----------------------|----------------|--|---------------------|------------------|-------|
| | | CLEAR | AB AFLAME AMBER ANTIQUÉ GOLD SILVER | | | |
| | | | BB BW OG OS VL VM | | | |
| | inch | EURO piece | EURO piece | BOX pieces | CARTON pieces | |
|  | <u>A.2020</u> | | | | | |
| | 14 mm | 0,0976 | 0,2406 | 1.500 | 9.000 | |
| | 16 mm | 0,1700 | 0,3346 | 1.188 | 7.128 | |
| | 18 mm | 0,2097 | 0,4198 | 960 | 5.760 | |
| | 20 mm | 0,2405 | 0,4995 | 585 | 3.510 | |
| | 22 mm | 0,3001 | 0,5887 | 520 | 3.120 | |
| | 24 mm | 0,3851 | 0,7249 | 308 | 1.848 | |
| | 26 mm | 0,4520 | 0,8598 | 308 | 1.848 | |
| 28 mm | 0,5045 | 1,0204 | 264 | 1.584 | | |
|  | <u>A.2024</u> | | | | | |
| | 14 mm | 0,0976 | 0,2406 | 1.500 | 9.000 | |
| | 16 mm | 0,1700 | 0,3346 | 1.188 | 7.128 | |
| | 18 mm | 0,2097 | 0,4198 | 960 | 5.760 | |
| | 20 mm | 0,2405 | 0,4995 | 585 | 3.510 | |
| | 22 mm | 0,3001 | 0,5887 | 520 | 3.120 | |
| | 24 mm | 0,3851 | 0,7249 | 308 | 1.848 | |
| | 26 mm | 0,4520 | 0,8598 | 308 | 1.848 | |
| 28 mm | 0,5045 | 1,0204 | 264 | 1.584 | | |
|  | <u>A.0610</u> | | | | | |
| | 63x22 mm | 2.5" | 0,8552 | 1,8404 | 175 | 1.050 |
| | 76x22 mm | 3" | 0,9890 | 2,0970 | 128 | 768 |
| | 100x28 mm | 4" | 2,0522 | 4,6894 | 50 | 300 |
| | 150x28 mm | 6" | 5,2833 | 10,5621 | 30 | 180 |
| | 200x28 mm | 8" | 6,9738 | 15,5666 | 15 | 90 |
| 250x28 mm | 10" | 10,8920 | 21,3941 | 15 | 90 | |
|  | <u>A.0611</u> | | | | | |
| | 63x22 mm | 2.5" | 0,8552 | 1,8404 | 175 | 1.050 |
| | 76x22 mm | 3" | 0,9890 | 2,0970 | 128 | 768 |
| | 100x28 mm | 4" | 2,0522 | 4,6894 | 50 | 300 |
| | 150x28 mm | 6" | 5,2833 | 10,5621 | 30 | 180 |
| | 200x28 mm | 8" | 6,9738 | 15,5666 | 15 | 90 |
| 250x28 mm | 10" | 10,8920 | 21,3941 | 15 | 90 | |
|  | <u>A.0600</u> | | | | | |
| | 100x28 mm | 4" | 1,8895 | 4,5267 | 50 | 300 |
|  | <u>A.0601</u> | | | | | |
| | 100x28 mm | 4" | 1,8895 | 4,5267 | 50 | 300 |

| | CRYSTAL CLEAR | CRYSTAL coated AB AFLAME AMBER ANTIQUÉ GOLD SILVER | minimum quantity | | |
|------|------------------|---|---------------------|------------------|--|
| inch | EURO piece | EURO piece | BOX pieces | CARTON pieces | |

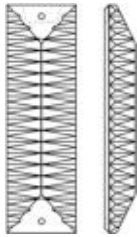

A.0640

100x28 mm

4" |

1,8895 |

4,5267 |

50

300

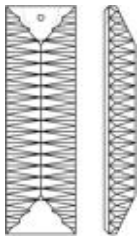

A.0641

100x28 mm

4" |

1,8895 |

4,5267 |

50

300

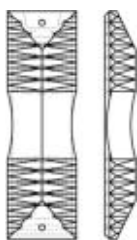

A.0670

100x28 mm

4" |

1,8895 |

4,5267 |

50

300

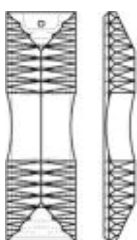

A.0671

100x28 mm

4" |

1,8895 |

4,5267 |

50

300

| | CRYSTAL CLEAR | CRYSTAL coated AB AFLAME AMBER ANTIQUÉ GOLD SILVER | minimum quantity | | |
|------|------------------|---|---------------------|------------------|--|
| inch | EURO piece | EURO piece | BOX pieces | CARTON pieces | |

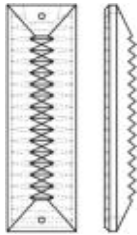

A.0650
100x28 mm 4" 1,8895 | 4,5267 | 50 300

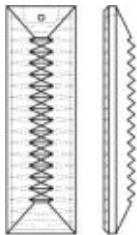



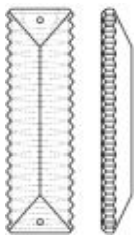

A.0651
100x28 mm 4" 1,8895 | 4,5267 | 50 300

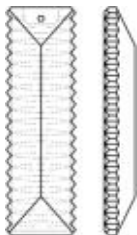





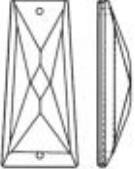
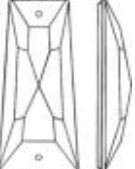
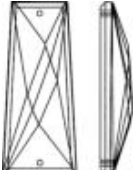

A.0660
100x28 mm 4" 1,8895 | 4,5267 | 50 300







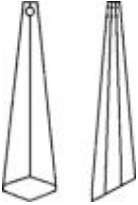
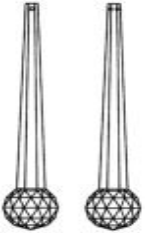

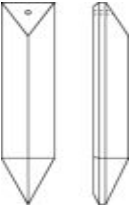
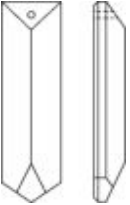
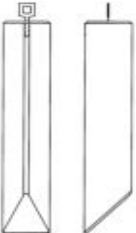

A.0661
100x28 mm 4" 1,8895 | 4,5267 | 50 300

| | | | CRYSTAL | CRYSTAL coated | minimum quantity | |
|---|---------------|---------|---------------|--|---------------------|------------------|
| | | | CLEAR | AB AFLAME AMBER ANTIQUÉ GOLD SILVER | | |
| | | | | BB BW OG OS VL VM | | |
| | inch | | EURO piece | EURO piece | BOX pieces | CARTON pieces |
|  | A.0604 | | | | | |
| | 52x18x14 mm | 2" | 0,7377 | 1,4546 | 324 | 1.944 |
| | 58x26x18 mm | 2.25" | 0,9619 | 2,1783 | 168 | 1.008 |
| | 63x30x22 mm | 2.5" | 1,2621 | 2,5848 | 100 | 600 |
| | 76x34x24 mm | 3" | 1,6418 | 3,4604 | 48 | 288 |
| | 89x36x26 mm | 3.5" | 2,7393 | 4,9723 | 30 | 180 |
| 100x40x28 mm | 4" | 4,1858 | 7,3268 | 27 | 162 | |
|  | A.0605 | | | | | |
| | 52x18x14 mm | 2" | 0,7377 | 1,4546 | 324 | 1.944 |
| 76x33x19 mm | 3" | 1,6418 | 3,4604 | 48 | 288 | |
|  | A.0606 | | | | | |
| | 52x18x14 mm | 2" | 0,7377 | 1,4546 | 324 | 1.944 |
| 76x33x19 mm | 3" | 1,6418 | 3,4604 | 48 | 288 | |
|  | A.0616 | | | | | |
| | 52x18x14 mm | 2" | 0,5912 | 1,3081 | 288 | 1.728 |
| | 58x26x18 mm | 2.25" | 0,9764 | 2,1927 | 168 | 1.008 |
| | 63x30x22 mm | 2.5" | 1,1210 | 2,4437 | 100 | 600 |
| | 76x34x24 mm | 3" | 1,6146 | 3,4333 | 48 | 288 |
| | 89x36x26 mm | 3.5" | 2,7085 | 4,9416 | 24 | 144 |
| 100x40x28 mm | 4" | 11,2102 | 14,3513 | 27 | 162 | |
|  | A.0614 | | | | | |
| | 52x18x14 mm | 2" | 0,5912 | 1,3081 | 288 | 1.728 |
| | 58x26x18 mm | 2.25" | 0,9764 | 2,1927 | 168 | 1.008 |
| | 63x30x22 mm | 2.5" | 1,1210 | 2,4437 | 100 | 600 |
| | 76x34x24 mm | 3" | 1,6146 | 3,4333 | 48 | 288 |
| | 89x36x26 mm | 3.5" | 2,7085 | 4,9416 | 24 | 144 |
| 100x40x28 mm | 4" | 11,2102 | 14,3513 | 27 | 162 | |
|  | A.0618 | | | | | |
| | 52x18x14 mm | 2" | 0,5912 | 1,3081 | 288 | 1.728 |
| | 58x26x18 mm | 2.25" | 0,9764 | 2,1927 | 144 | 864 |
| | 63x30x22 mm | 2.5" | 1,1210 | 2,4437 | 100 | 600 |
| | 76x34x24 mm | 3" | 1,6146 | 3,4333 | 48 | 288 |
| | 89x36x26 mm | 3.5" | 2,7085 | 4,9416 | 24 | 144 |
| 100x40x28 mm | 4" | 11,2102 | 14,3513 | 27 | 162 | |
|  | A.0612 | | | | | |
| | 52x18x14 mm | 2" | 0,5912 | 1,3081 | 288 | 1.728 |
| | 58x26x18 mm | 2.25" | 0,9764 | 2,1927 | 168 | 1.008 |
| | 63x30x22 mm | 2.5" | 1,1210 | 2,4437 | 100 | 600 |
| | 76x34x24 mm | 3" | 1,6146 | 3,4333 | 48 | 288 |
| | 89x36x26 mm | 3.5" | 2,7085 | 4,9416 | 24 | 144 |
| 100x40x28 mm | 4" | 11,2102 | 14,3513 | 27 | 162 | |

| | | | CRYSTAL | CRYSTAL coated | minimum quantity | |
|---|---|-----------------------------------|--|--|---------------------------------|---|
| | | | CLEAR | AB AFLAME AMBER ANTIQUÉ GOLD SILVER | | |
| | | | | BB BW OG OS VL VM | | |
| | | inch | EURO piece | EURO piece | BOX pieces | CARTON pieces |
|  | A.0405 20x11 mm | 0.75" | 0,1718 | 0,3506 | 880 | 5.280 |
|  | A.0401 38x14 mm 50x15 mm 63x16 mm 76x17 mm | 1.5" 2" 2.5" 3" | 0,2351 0,4321 0,9004 1,3181 | 0,5867 0,7984 1,4481 2,3246 | 420 288 210 140 | 2.520 1.728 1.260 840 |
|  | A.0424 20x11 mm 50x12 mm 63x14 mm 76x17 mm | 0.75" 2" 2.5" 3" | 0,1591 0,4321 1,1127 1,4519 | 0,3382 0,8092 1,6246 2,4584 | 990 288 210 168 | 5.940 1.728 1.260 1.008 |
|  | A.0485 63x14 mm 76x17 mm | 2.5" 3" | 1,1127 1,4519 | 1,6246 2,4584 | 210 168 | 1.260 1.008 |
|  | A.0432 20x11 mm 38x12 mm 50x15 mm 63x16 mm 76x17 mm | 0.75" 1.5" 2" 2.5" 3" | 0,1591 0,2938 0,4862 1,1127 1,6476 | 0,3382 0,6069 0,9103 1,7289 2,9057 | 880 480 288 210 168 | 5.280 2.880 1.728 1.260 1.008 |

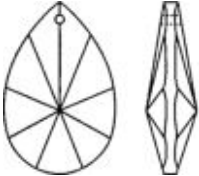
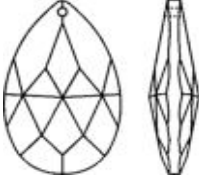
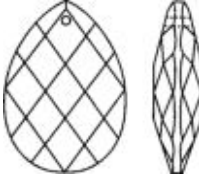
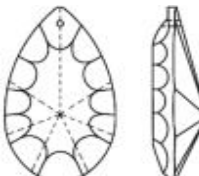
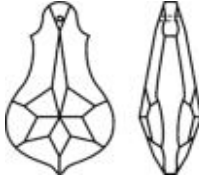

| | | CRYSTAL | CRYSTAL coated | minimum quantity | | |
|---|--|------------------------------|--|--|------------------------------|-----------------------------------|
| | | CLEAR | AB AFLAME AMBER ANTIQUÉ GOLD SILVER | | | |
| | | | BB BW OG OS VL VM | | | |
| inch | | EURO piece | EURO piece | BOX pieces | CARTON pieces | |
|  | A.0505 63x18 mm 76x20 mm 100x26 mm 125x28 mm 150x30 mm | 2.5" 3" 4" 5" 6" | 0,8430 1,1127 2,2005 4,2725 6,2696 | 1,6283 2,2457 3,7847 6,4606 9,8008 | 175 140 48 44 32 | 1.050 840 288 264 192 |
|  | A.0508 76+30 mm 100+40 mm | 3" 4" | 2,6525 4,4642 | 4,6998 6,6720 | 24 16 | 144 96 |
|  | A.0630 55x30 mm | 2.25" | 3,2437 | 4,7794 | 75 | 450 |
|  | A.0502 89x20 mm | 3.5" | 1,3283 | 2,7599 | 119 | 714 |
|  | A.0504 63x18 mm 76x18 mm | 2.5" 3" | 0,6148 0,9520 | 1,1626 2,1745 | 210 144 | 1.260 864 |
|  | A.00TR 100x30 mm 150x30 mm 180x30 mm 200x30 mm | 4" 6" 7" 8" | 9,2213 11,3910 14,8264 15,0072 | | 24 16 8 8 | 144 96 48 48 |
| | <u>metal-suspension:</u> CHROME | | | | | |



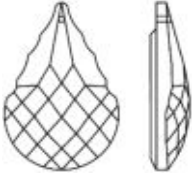
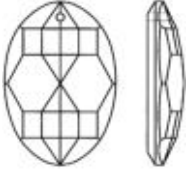
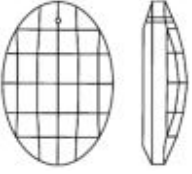
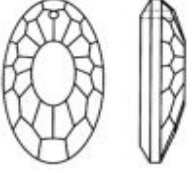
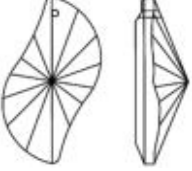
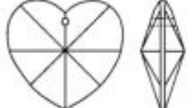

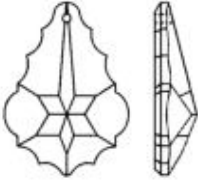
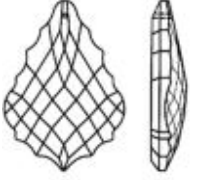
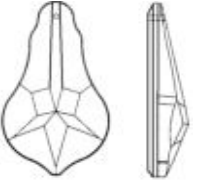
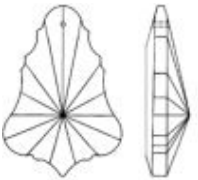
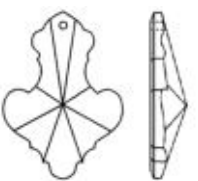
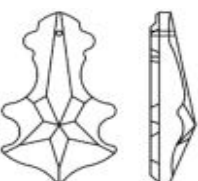
| | | CRYSTAL | CRYSTAL coated | minimum quantity | |
|---|---------------|---------------|--|---------------------|------------------|
| | | CLEAR | AB AFLAME AMBER ANTIQUÉ GOLD SILVER | | |
| | | | BB BW OG OS VL VM | | |
| | inch | EURO piece | EURO piece | BOX pieces | CARTON pieces |
|  | A.0701 | | | | |
| | 20 mm | 0,9113 | 1,3140 | 260 | 1.560 |
| | 30 mm | 0,9619 | 1,6137 | 90 | 540 |
| | 40 mm | 1,6038 | 2,4228 | 40 | 240 |
| | 50 mm | 4,9126 | 6,1784 | 12 | 72 |
| | 60 mm | 9,6842 | 11,5403 | 4 | 24 |
| | 70 mm | 19,0529 | 23,0367 | 4 | 24 |
| | 100 mm | 123,0105 | | 3 | 18 |
|  | A.0730 | | | | |
| | 30 mm | 0,9619 | 1,6137 | 90 | 540 |
| | 40 mm | 1,6038 | 2,4228 | 40 | 240 |
| | 50 mm | 6,1060 | 7,3717 | 12 | 72 |
|  | A.0740 | | | | |
| | 30 mm | 0,9619 | 1,6137 | 90 | 540 |
| | 40 mm | 1,6038 | 2,4228 | 40 | 240 |
| | 50 mm | 6,1060 | 7,3717 | 12 | 72 |
|  | A.1502 | | | | |
| | 6 mm | 0,0741 | 0,2018 | 8.820 | 52.920 |
| | 8 mm | 0,0886 | 0,2163 | 1.936 | 11.616 |
| | 10 mm | 0,1139 | 0,2416 | 1.350 | 8.100 |
| | 12 mm | 0,1501 | 0,2777 | 1.400 | 8.400 |
| | 14 mm | 0,2332 | 0,3609 | 840 | 5.040 |
| | 16 mm | 0,3327 | 0,5240 | 630 | 3.780 |
| | 18 mm | 0,5533 | 0,7685 | 470 | 2.820 |
| 20 mm | 0,7684 | 1,0685 | 260 | 1.560 | |
|  | A.1503 | | | | |
| | 8 mm | 0,0886 | 0,2163 | 2.112 | 12.672 |
| | 10 mm | 0,1139 | 0,2416 | 1.760 | 10.560 |
| | 12 mm | 0,1501 | 0,2777 | 1.600 | 9.600 |
| | 14 mm | 0,2332 | 0,3609 | 960 | 5.760 |
| | 16 mm | 0,3327 | 0,5240 | 630 | 3.780 |
| | 18 mm | 0,5533 | 0,7685 | 564 | 3.384 |
| | 20 mm | 0,7684 | 1,0685 | 376 | 2.256 |
|  | A.1504 | | | | |
| | 8 mm | 0,0886 | 0,2163 | 2.112 | 12.672 |
| | 10 mm | 0,1139 | 0,2416 | 1.760 | 10.560 |
| | 12 mm | 0,1501 | 0,2777 | 1.600 | 9.600 |
| | 14 mm | 0,2332 | 0,3609 | 960 | 5.760 |
| | 16 mm | 0,3327 | 0,5240 | 630 | 3.780 |
| | 18 mm | 0,5533 | 0,7685 | 564 | 3.384 |
| | 20 mm | 0,7684 | 1,0685 | 376 | 2.256 |

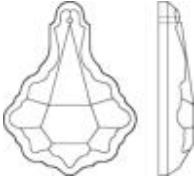
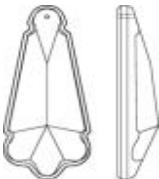
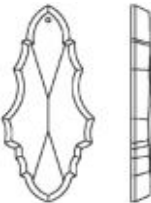
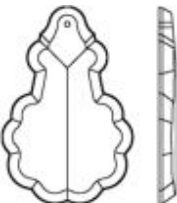
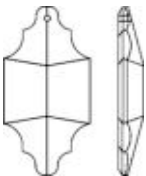
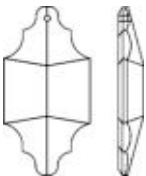

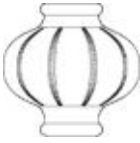
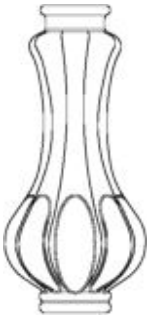

| | | CRYSTAL | CRYSTAL coated | minimum quantity | |
|---|---------------|---------------|--|---------------------|------------------|
| | | CLEAR | AB AFLAME AMBER ANTIQUÉ GOLD SILVER | | |
| | | | BB BW OG OS VL VM | | |
| inch | | EURO piece | EURO piece | BOX pieces | CARTON pieces |
|  | A.0873 | | | | |
| | 28x17 mm | 1.25" | 0,4665 | 0,7723 | 504 3.024 |
| | 38x22 mm | 1.5" | 0,6328 | 1,1111 | 308 1.848 |
| | 50x29 mm | 2" | 0,8118 | 1,6030 | 135 810 |
| | 63x37 mm | 2.5" | 1,7050 | 2,9747 | 72 432 |
| | 76x44 mm | 3" | 2,8459 | 4,6668 | 30 180 |
| | 89x52 mm | 3.5" | 3,9652 | 7,2435 | 24 144 |
| | 100x55 mm | 4" | 6,0879 | 11,7368 | 14 84 |
|  | A.0872 | | | | |
| | 38x22 mm | 1.5" | 0,7250 | 1,2034 | 308 1.848 |
| | 50x29 mm | 2" | 0,8516 | 1,6426 | 135 810 |
| | 63x37 mm | 2.5" | 1,8696 | 3,1392 | 72 432 |
| | 76x44 mm | 3" | 3,2727 | 5,0935 | 40 240 |
| | 89x52 mm | 3.5" | 4,3503 | 7,7540 | 24 144 |
| | 100x55 mm | 4" | 7,5434 | 13,1923 | 14 84 |
| | 125x70 mm | 5" | 11,7906 | 19,7988 | 6 36 |
|  | A.0874 | | | | |
| | 38x25 mm | 1.5" | 0,8096 | 1,3778 | 224 1.344 |
| | 50x35 mm | 2" | 0,9581 | 2,0435 | 96 576 |
| | 63x42 mm | 2.5" | 2,3392 | 3,9379 | 45 270 |
| | 76x52 mm | 3" | 3,6695 | 5,9732 | 30 180 |
| | 89x57 mm | 3.5" | 4,8941 | 8,7238 | 18 108 |
| | 100x64 mm | 4" | 8,4802 | 14,8352 | 12 72 |
| | 115x73 mm | 4.5" | 9,5522 | 17,0241 | 12 72 |
| | 125x81 mm | 5" | 14,7383 | 24,7484 | 6 36 |
|  | A.0973 | | | | |
| | 50x29 mm | 2" | 0,6039 | 1,3945 | 135 810 |
| | 63x37 mm | 2.5" | 1,6002 | 2,8914 | 64 384 |
| | 76x44 mm | 3" | 1,8533 | 4,0093 | 40 240 |
| | 89x52 mm | 3.5" | 2,2185 | 5,6221 | 24 144 |
| | 100x55 mm | 4" | 3,5927 | 9,2415 | 15 90 |
|  | A.0877 | | | | |
| | 63x37 mm | 2.5" | 1,8551 | 3,1247 | 80 480 |
|  | A.0990 | | | | |
| | 89x60 mm | 3.5" | 21,1548 | 24,5590 | 24 144 |

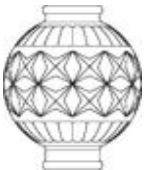
| | | | CRYSTAL | CRYSTAL coated | minimum quantity | |
|---|---------------|------|---------------|--|---------------------|------------------|
| | | | CLEAR | AB AFLAME AMBER ANTIQUÉ GOLD SILVER | | |
| | | | | BB BW OG OS VL VM | | |
| | inch | | EURO piece | EURO piece | BOX pieces | CARTON pieces |
|  | A.0918 | | | | | |
| | 50x33 mm | 2" | 0,5696 | 1,5344 | 140 | 840 |
| | 63x42 mm | 2.5" | 0,8408 | 2,1324 | 80 | 480 |
| | 76x50 mm | 3" | 1,4356 | 3,5916 | 48 | 288 |
| | 89x58 mm | 3.5" | 2,0359 | 5,4396 | 24 | 144 |
|  | A.0929 | | | | | |
| | 63x42 mm | 2.5" | 1,0378 | 2,3291 | 60 | 360 |
| | 76x50 mm | 3" | 1,5007 | 3,5479 | 32 | 192 |
| | 89x58 mm | 3.5" | 2,2909 | 5,5689 | 20 | 120 |
| | 100x66 mm | 4" | 3,2745 | 9,0291 | 16 | 96 |
|  | A.0919 | | | | | |
| | 50x33 mm | 2" | 0,7481 | 1,7911 | 114 | 684 |
| | 63x42 mm | 2.5" | 0,9644 | 2,2560 | 60 | 360 |
| | 76x50 mm | 3" | 1,6021 | 3,7581 | 32 | 192 |
| | 89x58 mm | 3.5" | 2,6615 | 6,0651 | 20 | 120 |
|  | A.0925 | | | | | |
| | 50x29 mm | 2" | 0,5153 | 1,5584 | 98 | 588 |
| | 63x37 mm | 2.5" | 0,9004 | 2,1917 | 60 | 360 |
| | 76x44 mm | 3" | 1,5007 | 3,6569 | 32 | 192 |
| | 89x52 mm | 3.5" | 2,2909 | 5,6945 | 20 | 120 |
| | 100x60 mm | 4" | 3,2745 | 9,5198 | 16 | 96 |
|  | A.0922 | | | | | |
| | 50x29 mm | 2" | 0,6039 | 1,6468 | 144 | 864 |
| | 63x37 mm | 2.5" | 0,7377 | 2,0064 | 90 | 540 |
| | 76x44 mm | 3" | 1,4465 | 3,6025 | 48 | 288 |
| | 89x52 mm | 3.5" | 1,9292 | 5,3328 | 20 | 120 |
|  | A.0870 | | | | | |
| | 28 mm | 1.1" | 0,5243 | 1,0838 | 308 | 1.848 |

| | | CRYSTAL | CRYSTAL coated | minimum quantity | |
|---|---------------|---------------|--|---------------------|------------------|
| | | CLEAR | AB AFLAME AMBER ANTIQUÉ GOLD SILVER | | |
| | | | BB BW OG OS VL VM | | |
| inch | | EURO piece | EURO piece | BOX pieces | CARTON pieces |
|  | A.0911 | | | | |
| | 38x26 mm | 1.5" | 0,3562 | 0,9161 | 384 1.152 |
| | 50x35 mm | 2" | 0,5804 | 1,5452 | 140 840 |
| | 63x44 mm | 2.5" | 0,8408 | 2,1325 | 80 480 |
| | 76x53 mm | 3" | 1,3922 | 3,4415 | 48 288 |
| | 89x61 mm | 3.5" | 2,0323 | 5,4384 | 32 192 |
| | 100x69 mm | 4" | 3,0394 | 7,9196 | 20 120 |
| | 115x78 mm | 4.5" | 4,1261 | 11,5314 | 16 96 |
| | 125x89 mm | 5" | 6,2506 | 14,6724 | 9 54 |
|  | A.0910 | | | | |
| | 50x35 mm | 2" | 0,5804 | 1,5452 | 140 840 |
| | 63x44 mm | 2.5" | 0,8408 | 2,1325 | 80 480 |
| | 76x53 mm | 3" | 1,3922 | 3,4415 | 48 288 |
| | 89x61 mm | 3.5" | 2,0323 | 5,4384 | 32 192 |
|  | A.0916 | | | | |
| | 50x29 mm | 2" | 0,4014 | 1,3117 | 168 1.008 |
| | 63x37 mm | 2.5" | 0,5894 | 1,8811 | 100 600 |
| | 76x44 mm | 3" | 1,0523 | 3,1009 | 48 288 |
|  | A.0917 | | | | |
| | 50x36 mm | 2" | 0,5822 | 1,5470 | 144 864 |
| | 63x44 mm | 2.5" | 0,8408 | 2,1325 | 75 450 |
| | 76x54 mm | 3" | 1,3940 | 3,4426 | 40 240 |
| | 89x64 mm | 3.5" | 2,0377 | 5,4438 | 21 126 |
| | 100x71 mm | 4" | 3,0412 | 7,9214 | 18 108 |
|  | A.0915 | | | | |
| | 50x33 mm | 2" | 0,4972 | 1,4620 | 168 1.008 |
| | 63x42 mm | 2.5" | 0,7165 | 2,3255 | 108 648 |
| | 76x50 mm | 3" | 1,0116 | 3,4040 | 60 360 |
| | 89x58 mm | 3.5" | 1,5694 | 5,2384 | 32 192 |
| | 100x66 mm | 4" | 2,3469 | 7,2010 | 30 180 |
|  | A.0921 | | | | |
| | 50x29 mm | 2" | 0,5533 | 1,5962 | 168 1.008 |
| | 63x37 mm | 2.5" | 0,7486 | 2,0401 | 90 540 |
| | 76x44 mm | 3" | 1,2639 | 3,4199 | 60 360 |
| | 89x52 mm | 3.5" | 1,6851 | 5,0888 | 20 120 |
| | 100x58 mm | 4" | 2,5351 | 7,1224 | 24 144 |

| | | CRYSTAL | CRYSTAL coated | minimum quantity | | |
|---|-------------------------|---------------|--|---------------------|------------------|-----|
| | | CLEAR | AB AFLAME AMBER ANTIQUÉ GOLD SILVER | | | |
| | | | BB BW OG OS VL VM | | | |
| | inch | EURO piece | EURO piece | BOX pieces | CARTON pieces | |
|  | A.0902 | | | | | |
| | 63x47 mm | 2.5" | 0,8245 | 2,1115 | 84 | 504 |
| | 89x67 mm | 3.5" | 2,2655 | 6,1024 | 42 | 252 |
| | 100x77 mm | 4" | 2,3939 | 9,3359 | 24 | 144 |
|  | A.0906 | | | | | |
| | 89x40 mm | 3.5" | 2,2692 | 6,1767 | 40 | 240 |
| | 100x45 mm | 4" | 2,6059 | 9,8043 | 24 | 144 |
|  | A.0907 | | | | | |
| | 100x45 mm | 4" | 2,2782 | 5,9649 | 36 | 216 |
| | 125x55 mm | 5" | 4,3449 | 12,3534 | 25 | 150 |
|  | A.0908 | | | | | |
| | 115x72 mm | 4.5" | 4,0212 | 11,4265 | 16 | 96 |
| | 125x80 mm | 5" | 5,5436 | 13,7900 | 12 | 72 |
|  | A.0913 | | | | | |
| | 63x30 mm | 2.5" | 0,8335 | 2,2016 | 98 | 588 |
|  | A.0914 (2-holes) | | | | | |
| | 63x30 mm | 2.5" | 0,8335 | 2,2016 | 98 | 588 |
|  | A.3040 | | | | | |
| | 55x55 mm | 2.2" | 21,1548 | 25,3857 | 5 | 30 |
| | 100x80 mm | 4" | 35,9812 | 42,3095 | 1 | 6 |

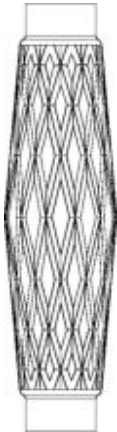
| | | | | CRYSTAL | minimum quantity | |
|---|--|------|--------------------|------------|------------------|---------------|
| | | | | CLEAR | | |
| | | inch | | EURO piece | PACK pieces | CARTON pieces |
|  | A.0201 center hole: 80x80 mm | 3.2" | <u>20/24 mm</u> | 9,9446 | 1 | 32 |
|  | A.0202 center hole: 170x75 mm | 6.7" | <u>24/26 mm</u> | 7,9556 | 1 | 24 |
|  | A.0203 center hole: 80x50 mm | 3.2" | <u>20/22/30 mm</u> | 7,0516 | 1 | 30 |
|  | A.0204 center hole: 170x70 mm | 6.7" | <u>16/24/40 mm</u> | 6,5092 | 1 | 24 |
|  | A.0205 center hole: 100x85 mm | 4" | <u>20/24 mm</u> | 6,6900 | 1 | 32 |
|  | A.0206 center hole: 170x75 mm | 6.7" | <u>20/26 mm</u> | 9,4021 | 1 | 24 |

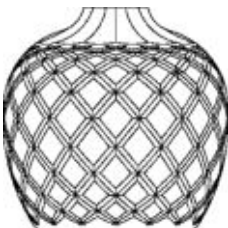
| | inch | | CRYSTAL CLEAR | minimum quantity | EURO piece | PACK pieces | CARTON pieces |
|---|------|--|------------------|-----------------------------------|---------------|----------------|------------------|
|  | | <u>A.0207</u> center hole: 95x75 mm | | <u>46/46 mm</u> | 3.8" | 7,0516 | 1 20 |
|  | | <u>A.0208</u> center hole: 145x75 mm | | <u>38/42 mm</u> | 5.7" | 9,0405 | 1 16 |
|  | | <u>A.0209</u> center hole: 230x60 mm | | <u>28/32 mm</u> | 9" | 11,0294 | 1 12 |
|  | | <u>A.0210</u> center hole: 280x85 mm | | <u>32/36 mm</u> | 11" | 13,0183 | 1 12 |
|  | | <u>A.0211</u> center hole: 130x130 mm drilling of CH at bottom : | | <u>20 mm</u> <u>1,2500</u> | 5.1" | 37,2125 | 1 6 |

| | CRYSTAL | CRYSTAL | minimum quantity | |
|------|------------|------------|------------------|---------------|
| | CLEAR | CLEAR | | |
| inch | EURO piece | EURO piece | BOX pieces | CARTON pieces |

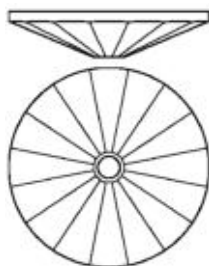

A.1038

| <u>center hole:</u> | | <u>10 mm</u> | <u>26 mm</u> | | |
|---------------------------------|----|--------------|--------------|---|----|
| 100x22 mm | 4" | 10,1254 | 10,1254 | 9 | 54 |
| 100x22 mm - 4 SH | 4" | 11,6454 | 11,6454 | 9 | 54 |
| <u>drilling of extra SH :</u> | | 0,3800 | 0,3800 | | |
| <u>stud-insertion into SH :</u> | | | | | |
| BRASS | | 0,0900 | 0,0900 | | |
| CHROME-PLATED | | 0,1000 | 0,1000 | | |
| GOLD-PLATED | | 0,1200 | 0,1200 | | |

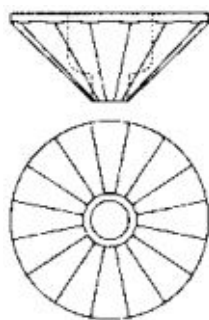

A.1037

| <u>center hole:</u> | | <u>19/44 mm</u> | | | |
|---------------------------------|----|-----------------|--|---|----|
| 100x52 mm | 4" | 18,8042 | | 5 | 33 |
| 120x46 mm | 5" | 25,3134 | | 1 | 18 |
| <u>drilling of extra SH :</u> | | 0,3800 | | | |
| <u>stud-insertion into SH :</u> | | | | | |
| BRASS | | 0,0900 | | | |
| CHROME-PLATED | | 0,1000 | | | |
| GOLD-PLATED | | 0,1200 | | | |

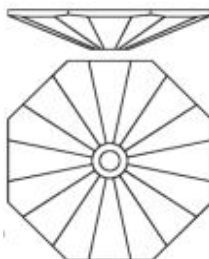

A.1036

| <u>center hole:</u> | | <u>10 mm</u> | <u>26 mm</u> | | |
|---------------------------------|----|--------------|--------------|---|----|
| 100x22 mm | 4" | 10,6678 | 10,6678 | 9 | 54 |
| 100x22 mm - 4 SH | 4" | 12,1878 | 12,1878 | 9 | 54 |
| 120x30 mm | 5" | 18,6053 | 18,6053 | 6 | 36 |
| 120x30 mm - 4 SH | 5" | 20,1254 | 20,1254 | 6 | 36 |
| <u>drilling of extra SH :</u> | | 0,3800 | 0,3800 | | |
| <u>stud-insertion into SH :</u> | | | | | |
| BRASS | | 0,0900 | 0,0900 | | |
| CHROME-PLATED | | 0,1000 | 0,1000 | | |
| GOLD-PLATED | | 0,1200 | 0,1200 | | |

| | CRYSTAL | CRYSTAL | minimum quantity | |
|------|------------|------------|------------------|---------------|
| | CLEAR | CLEAR | | |
| inch | EURO piece | EURO piece | BOX pieces | CARTON pieces |

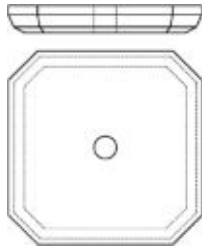

A.0100

| <u>center hole:</u> | | <u>10 mm</u> | <u>26 mm</u> | | |
|---------------------------------|------|--------------|--------------|----|-----|
| 90x13 mm | 3.5" | 12,5099 | 12,5099 | 18 | 108 |
| 90x13 mm - 4 SH | 3.5" | 14,0299 | 14,0299 | 18 | 108 |
| <u>drilling of extra SH :</u> | | 0,3800 | 0,3800 | | |
| <u>stud-insertion into SH :</u> | | | | | |
| BRASS | | 0,0900 | 0,0900 | | |
| CHROME-PLATED | | 0,1000 | 0,1000 | | |
| GOLD-PLATED | | 0,1200 | 0,1200 | | |

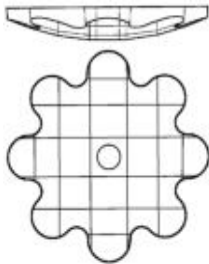

A.1039

| <u>center hole:</u> | | <u>10 mm</u> | <u>26 mm</u> | | |
|---------------------------------|----|--------------|--------------|---|----|
| 100x15 mm | 4" | 8,3173 | 8,3173 | 9 | 54 |
| 100x15 mm - 4 SH | 4" | 9,8373 | 9,8373 | 9 | 54 |
| <u>drilling of extra SH :</u> | | 0,3800 | 0,3800 | | |
| <u>stud-insertion into SH :</u> | | | | | |
| BRASS | | 0,0900 | 0,0900 | | |
| CHROME-PLATED | | 0,1000 | 0,1000 | | |
| GOLD-PLATED | | 0,1200 | 0,1200 | | |

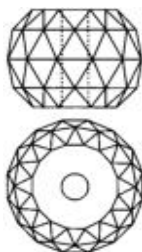

A.0710

| | | | <u>coated</u> | | |
|-------------------|----------|----------|---------------|-------|--|
| 20 mm CH: 6,0mm | 1,4826 | 2,3659 | 325 | 1.950 | |
| 30 mm CH: 12,5mm | 1,9066 | 2,8840 | 90 | 540 | |
| 40 mm CH: 12,5mm | 2,6308 | 3,6242 | 40 | 240 | |
| 50 mm CH: 12,5mm | 6,4420 | 7,8645 | 24 | 144 | |
| 60 mm CH: 14,5mm | 12,5482 | 14,4043 | 8 | 48 | |
| 70 mm CH: 14,5mm | 23,7856 | 26,9726 | 8 | 48 | |
| 100 mm CH: 14,5mm | 155,1639 | 162,9899 | 3 | 18 | |

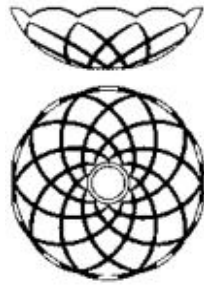

A.0103

| | inch | CRYSTAL CLEAR EURO piece | CRYSTAL CLEAR EURO piece | minimum quantity | CARTON pieces |
|---------------------------------|------|-----------------------------------|-----------------------------------|---------------------|------------------|
| <u>center hole:</u> | | <u>10 mm</u> | <u>26 mm</u> | | |
| 100x33 mm - 5 SH | 4" | 2,5313 | 2,5313 | 9 | 99 |
| 120x38 mm - 5 SH | 5" | 3,2546 | 3,2546 | 8 | 64 |
| 150x44 mm - 5 SH | 6" | 4,7011 | 4,7011 | 5 | 60 |
| <u>center hole:</u> | | <u>13 mm</u> | | | |
| 200x56 mm (18 bend | 8" | 10,1254 | | 1 | 10 |
| 250x68 mm (22 bend | 10" | 17,9002 | | 1 | 1 |
| 300x86 mm (24 bend | 12" | 27,1215 | | 1 | 1 |
| 350x90 mm (28 bend | 14" | 53,7006 | | 1 | 1 |
| <u>drilling of extra SH :</u> | | 0,3800 | 0,3800 | | |
| <u>stud-insertion into SH :</u> | | | | | |
| BRASS | | 0,0900 | 0,0900 | | |
| CHROME-PLATED | | 0,1000 | 0,1000 | | |
| GOLD-PLATED | | 0,1200 | 0,1200 | | |
| <u>drilling of bigger CH :</u> | | 1,2500 | 1,2500 | | |

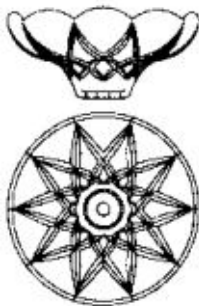

A.0104

| | | | | | |
|---------------------------------|----|--------------|--------------|---|----|
| <u>center hole:</u> | | <u>10 mm</u> | <u>26 mm</u> | | |
| 150x68 mm - 5 SH | 6" | 7,5940 | 7,5940 | 2 | 28 |
| <u>drilling of extra SH :</u> | | 0,3800 | 0,3800 | | |
| <u>stud-insertion into SH :</u> | | | | | |
| BRASS | | 0,0900 | 0,0900 | | |
| CHROME-PLATED | | 0,1000 | 0,1000 | | |
| GOLD-PLATED | | 0,1200 | 0,1200 | | |
| <u>drilling of bigger CH :</u> | | 1,2500 | 1,2500 | | |



A.0102

| | | | | | |
|---------------------------------|------|--------------|--------------|---|----|
| <u>center hole:</u> | | <u>10 mm</u> | <u>26 mm</u> | | |
| 110x40 mm - 5 SH | 4.3" | 2,8930 | 2,8930 | 8 | 88 |
| <u>drilling of extra SH :</u> | | 0,3800 | 0,3800 | | |
| <u>stud-insertion into SH :</u> | | | | | |
| BRASS | | 0,0900 | 0,0900 | | |
| CHROME-PLATED | | 0,1000 | 0,1000 | | |
| GOLD-PLATED | | 0,1200 | 0,1200 | | |
| <u>drilling of bigger CH :</u> | | 1,2500 | 1,2500 | | |



A.0101

| | | CRYSTAL | CRYSTAL | minimum quantity | | |
|---------------------------------|------|--------------|--------------|------------------|---------------|--|
| | | CLEAR | CLEAR | | | |
| inch | | EURO piece | EURO piece | BOX pieces | CARTON pieces | |
| <u>center hole:</u> | | <u>10 mm</u> | <u>26 mm</u> | | | |
| 85x22 mm - 5 SH | 3.3" | 1,8081 | 1,8081 | 14 | 140 | |
| 100x22 mm - 6 SH | 4" | 2,5313 | 2,5313 | 9 | 99 | |
| <u>drilling of extra SH :</u> | | 0,3800 | 0,3800 | | | |
| <u>stud-insertion into SH :</u> | | | | | | |
| BRASS | | 0,0900 | 0,0900 | | | |
| CHROME-PLATED | | 0,1000 | 0,1000 | | | |
| GOLD-PLATED | | 0,1200 | 0,1200 | | | |
| <u>drilling of bigger CH :</u> | | 1,2500 | 1,2500 | | | |

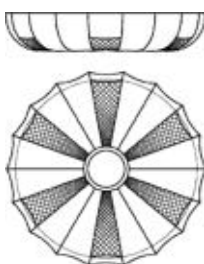

A.0106

| | | 10 mm | 26 mm | | | |
|---------------------------------|------|--------------|--------------|---|----|--|
| <u>center hole:</u> | | <u>10 mm</u> | <u>26 mm</u> | | | |
| 140x28 mm | 5.5" | 5,8872 | 5,8872 | 4 | 48 | |
| 140x28 mm - 6 SH | 5.5" | 8,1631 | 8,1631 | 4 | 48 | |
| <u>drilling of extra SH :</u> | | 0,3800 | 0,3800 | | | |
| <u>stud-insertion into SH :</u> | | | | | | |
| BRASS | | 0,0900 | 0,0900 | | | |
| CHROME-PLATED | | 0,1000 | 0,1000 | | | |
| GOLD-PLATED | | 0,1200 | 0,1200 | | | |
| <u>drilling of bigger CH :</u> | | 1,2500 | 1,2500 | | | |

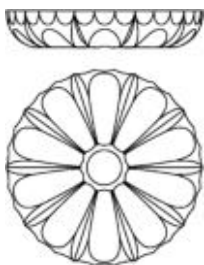





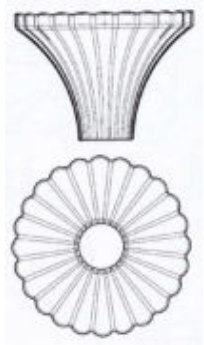



A.0105

| | | 10 mm | 26 mm | | | |
|---------------------------------|----|--------------|--------------|---|----|--|
| <u>center hole:</u> | | <u>10 mm</u> | <u>26 mm</u> | | | |
| 150x30 mm | 6" | 5,8872 | 5,8872 | 4 | 48 | |
| 150x30 mm - 5 SH | 6" | 7,7872 | 7,7872 | 4 | 48 | |
| <u>drilling of extra SH :</u> | | 0,3800 | 0,3800 | | | |
| <u>stud-insertion into SH :</u> | | | | | | |
| BRASS | | 0,0900 | 0,0900 | | | |
| CHROME-PLATED | | 0,1000 | 0,1000 | | | |
| GOLD-PLATED | | 0,1200 | 0,1200 | | | |
| <u>drilling of bigger CH :</u> | | 1,2500 | 1,2500 | | | |



A.0107

| | | | 26 mm | | | |
|---------------------------------|------|--------|--------------|---|----|--|
| <u>center hole:</u> | | | <u>26 mm</u> | | | |
| 105x74 mm | 4.1" | | 10,5774 | 4 | 24 | |
| 105x74 mm - 4 SH | 4.1" | | 12,0974 | 4 | 24 | |
| <u>drilling of extra SH :</u> | | 0,3800 | 0,3800 | | | |
| <u>stud-insertion into SH :</u> | | | | | | |
| BRASS | | 0,0900 | 0,0900 | | | |
| CHROME-PLATED | | 0,1000 | 0,1000 | | | |
| GOLD-PLATED | | 0,1200 | 0,1200 | | | |
| <u>drilling of bigger CH :</u> | | 1,2500 | 1,2500 | | | |

| | | | CRYSTAL | CRYSTAL | minimum quantity | |
|---|---------------|-----|--------------------------------|--------------------------------|------------------|---------------|
| | | | CLEAR | CLEAR | | |
| inch | | | EURO piece | EURO piece | PACK pieces | CARTON pieces |
| | | | <u>caps:</u> <u>Ø 23 mm</u> | <u>caps:</u> <u>Ø 23 mm</u> | | |
| | | | <u>CHROME</u> | <u>GOLD</u> | | |
|  | A.0001 | | | | | |
| | 150x19 mm | 6" | 9,4021 | 9,4021 | 1 | 30 |
| | 200x19 mm | 8" | 9,4021 | 9,4021 | 1 | 30 |
| | 250x19 mm | 10" | 10,8486 | 10,8486 | 1 | 30 |
| | 300x19 mm | 12" | 11,7527 | 11,7527 | 1 | 30 |
| | 360x19 mm | 14" | 12,6567 | 12,6567 | 1 | 30 |
|  | A.0002 | | | | | |
| | 150x19 mm | 6" | 9,9672 | 9,9672 | 1 | 30 |
| | 180x19 mm | 7" | 9,9672 | 9,9672 | 1 | 30 |
| | 250x19 mm | 10" | 11,5718 | 11,5718 | 1 | 30 |
| | 300x19 mm | 12" | 11,9335 | 11,9335 | 1 | 30 |
|  | A.0005 | | | | | |
| | 150x19 mm | 6" | 10,3740 | 10,3740 | 1 | 30 |
| | 200x19 mm | 8" | 10,8486 | 10,8486 | 1 | 30 |
| | 250x19 mm | 10" | 11,0294 | 11,0294 | 1 | 30 |
| | 300x19 mm | 12" | 13,5608 | 13,5608 | 1 | 30 |
|  | A.0003 | | | | | |
| | 200x19 mm | 8" | 9,4021 | 9,4021 | 1 | 30 |
| | 300x19 mm | 12" | 13,6512 | 13,6512 | 1 | 30 |
|  | A.0004 | | | | | |
| | 200x19 mm | 8" | 9,4021 | 9,4021 | 1 | 30 |
| | 300x19 mm | 12" | 13,6512 | 13,6512 | 1 | 30 |
|  | A.0021 | | | | | |
| | 240x19 mm | 10" | 7,9556 | 7,9556 | 1 | 64 |
|  | A.0022 | | | | | |
| | 360x19 mm | 14" | 9,9446 | 9,9446 | 1 | 32 |
|  | A.0023 | | | | | |
| | 150x19 mm | 6" | 7,9556 | 7,9556 | 1 | 64 |



PRECIOSA



PRECIOSA

lead crystal

glamorous brilliance

machine-cut

made by Preciosa

pinning service available

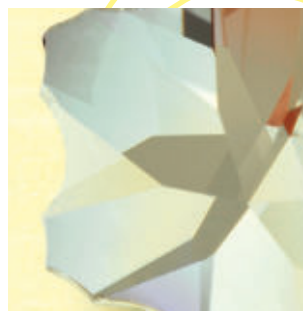

Schöler & Co. GmbH

Gablonzer Strasse 54-61
A-4550 Kremsmünster
Austria

T: ++43-75 83-77 23

F: ++43-75 83-78 12

E: office@scholer-crystal.at

W: www.scholer-crystal.at



ARTICLE INDEX

| <u>Article:</u> | <u>Page:</u> |
|---------------------|--------------|
| P.0100 | 12 |
| P.0115 | 12 |
| P.0134 | 12 |
| P.0137 | 12 |
| P.0433-61306 | 19 |
| P.0433-68301 | 19 |
| P.0433-68615 | 19 |
| P.0451-19002 | 18 |
| P.0451-19602 | 18 |
| P.0451-29901 | 18 |
| P.0451-51681 | 19 |
| P.0451-51984 | 19 |
| P.0451-52301 | 18 |
| P.0451-55001 | 18 |
| P.0451-69302 | 18 |
| P.0499-11001 | 17 |
| P.0968-99636 | 17 |
| P.0968-99637 | 17 |
| P.0968-99638 | 17 |
| P.1001 | 16 |
| P.1002 | 16 |
| P.1003 | 16 |
| P.1006 | 16 |
| P.1081 | 13 |
| P.1182 | 13 |
| P.1381 | 13 |
| P.1685 | 13 |
| P.2074 | 16 |
| P.2528 | 11 |
| P.2552 | 9 |
| P.2571 | 9 |
| P.2572 | 9 |
| P.2573 | 9 |
| P.2593 | 15 |
| P.2594 | 15 |
| P.2602 | 14 |
| P.2611 | 10 |
| P.2616 | 14 |
| P.2626 | 14 |
| P.2636 | 10 |
| P.2660 | 11 |
| P.2661 | 15 |
| P.2662 | 15 |
| P.2665 | 10 |
| P.2669 | 10 |
| P.2679 | 13 |
| P.2697 | 15 |
| P.2718 | 14 |
| P.2724 | 14 |
| P.2727 | 14 |
| P.2729 | 11 |
| P.2730 | 11 |
| P.6302 | 11 |

PRODUCT GROUP

Page:

| | | |
|--------------------------------|---|--------|
| OCTAGONS |  | 9 - 10 |
| ROUNDS & ROSETTES & BEADS |  | 11 |
| COFFIN STONES & POINTED STONES |  | 12 |
| ICICLES |  | 13 |
| BALLS & FINIALS & HEARTS |  | 14 |
| ALMONDS |  | 15 |
| PENDELOQUES |  | 16 |
| FANCY DESIGNS |  | 17 |
| BEADS |  | 18 |
| PENDANTS |  | 19 |

CHANDELIER LABEL

The PRECIOSA label is to ensure the authenticity and originality of a chandelier which is dressed with PRECIOSA lead crystal (30% PbO) components.



| inch | CRYSTAL | CRYSTAL coated | minimum quantity | CARTON pieces |
|------|---------------|--|---------------------|------------------|
| | CLEAR | AB AFLAME AMBER ANTIQUÉ GOLD SILVER | | |
| | EURO piece | EURO piece | BOX pieces | |

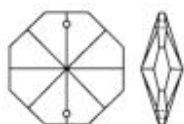

P.2552

| | | | | |
|-------|---------|---------|-------|--------|
| 10 mm | 0,0410 | 0,1404 | 3.276 | 39.312 |
| 12 mm | 0,0434 | 0,1428 | 2.160 | 25.920 |
| 14 mm | 0,0949 | 0,1947 | 1.540 | 18.480 |
| 16 mm | 0,0996 | 0,2497 | 1.080 | 12.960 |
| 18 mm | 0,1761 | 0,3242 | 720 | 8.640 |
| 20 mm | 0,5154 | 0,7013 | 490 | 5.880 |
| 22 mm | 0,8715 | 1,0791 | 336 | 4.032 |
| 24 mm | 0,8739 | 1,1182 | 240 | 2.880 |
| 26 mm | 0,8763 | 1,1689 | 120 | 1.440 |
| 28 mm | 0,9897 | 1,3303 | 120 | 1.440 |
| 30 mm | 1,1505 | 1,5324 | 100 | 1.200 |
| 32 mm | 1,1585 | 1,5725 | 100 | 1.200 |
| 34 mm | 1,3547 | 1,8109 | 50 | 600 |
| 36 mm | 1,5718 | 2,0688 | 50 | 600 |
| 38 mm | 1,6289 | 2,1960 | 50 | 600 |
| 40 mm | 2,1072 | 2,7524 | 50 | 600 |
| 45 mm | 6,9432 | 7,9696 | 50 | 600 |
| 50 mm | 7,5020 | 8,5284 | 28 | 336 |
| 60 mm | 11,5436 | 13,0209 | 20 | 240 |

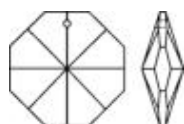

P.2571

| | | | | |
|-------|--------|--------|-------|--------|
| 10 mm | 0,0410 | 0,1404 | 3.276 | 39.312 |
| 12 mm | 0,0434 | 0,1428 | 2.160 | 25.920 |
| 14 mm | 0,0949 | 0,1947 | 1.540 | 18.480 |
| 16 mm | 0,0996 | 0,2497 | 1.080 | 12.960 |
| 18 mm | 0,1761 | 0,3242 | 720 | 8.640 |
| 20 mm | 0,5154 | 0,7013 | 490 | 5.880 |
| 22 mm | 0,8715 | 1,0791 | 336 | 4.032 |
| 24 mm | 0,8739 | 1,1182 | 240 | 2.880 |
| 28 mm | 0,9897 | 1,3303 | 120 | 1.440 |
| 30 mm | 1,1505 | 1,5324 | 100 | 1.200 |
| 32 mm | 1,1585 | 1,5725 | 100 | 1.200 |
| 36 mm | 1,5718 | 2,0688 | 50 | 600 |
| 40 mm | 2,1072 | 2,7524 | 50 | 600 |

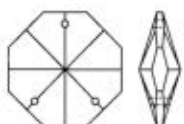

P.2572

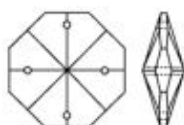

| | | | | |
|-------|--------|--------|-------|--------|
| 14 mm | 0,0949 | 0,1947 | 1.540 | 18.480 |
| 18 mm | 0,1761 | 0,3242 | 720 | 8.640 |
| 24 mm | 0,8739 | 1,1182 | 240 | 2.880 |

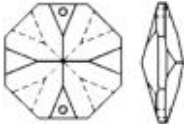
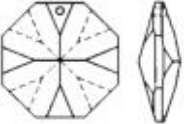
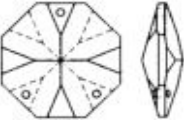
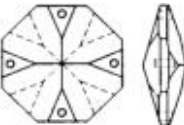

P.2573

| | | | | |
|-------|--------|--------|-------|--------|
| 16 mm | 0,0996 | 0,2497 | 1.080 | 12.960 |
| 18 mm | 0,1761 | 0,3242 | 720 | 8.640 |
| 24 mm | 0,8739 | 1,1182 | 240 | 2.880 |
| 40 mm | 2,1072 | 2,7524 | 50 | 600 |

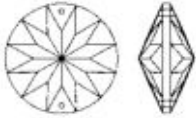
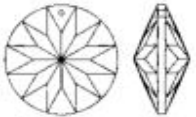
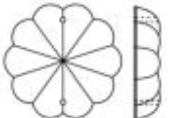
| inch | CRYSTAL | CRYSTAL coated | minimum quantity | CARTON pieces | |
|---|---------------|--|---------------------|------------------|--------|
| | CLEAR | AB AFLAME AMBER ANTIQUÉ GOLD SILVER | | | |
| | EURO piece | EURO piece | BOX pieces | | |
|  | P.2611 | | | | |
| | 10 mm | 0,0498 | 0,1492 | 3.276 | 39.312 |
| | 12 mm | 0,0539 | 0,1532 | 1.600 | 19.200 |
| | 14 mm | 0,1005 | 0,2003 | 1.540 | 18.480 |
| | 16 mm | 0,1162 | 0,2475 | 1.080 | 12.960 |
| | 18 mm | 0,1825 | 0,3306 | 720 | 8.640 |
| | 20 mm | 0,6874 | 0,8734 | 490 | 5.880 |
| | 22 mm | 0,8923 | 1,1266 | 336 | 4.032 |
| | 24 mm | 1,0066 | 1,2508 | 240 | 2.880 |
| | 26 mm | 1,1296 | 1,4221 | 120 | 1.440 |
| | 28 mm | 1,2590 | 1,5996 | 120 | 1.440 |
| | 30 mm | 1,4432 | 1,8251 | 100 | 1.200 |
| | 32 mm | 1,6003 | 2,0677 | 100 | 1.200 |
| | 34 mm | 1,6056 | 2,0618 | 50 | 600 |
| | 36 mm | 1,7848 | 2,2819 | 50 | 600 |
| | 38 mm | 1,9368 | 2,5040 | 50 | 600 |
| | 40 mm | 2,4385 | 3,0837 | 50 | 600 |
| 45 mm | 7,3303 | 8,6546 | 50 | 600 | |
| 50 mm | 8,8897 | 9,9160 | 28 | 336 | |
| 60 mm | 12,1667 | 13,6439 | 20 | 240 | |
|  | P.2636 | | | | |
| | 10 mm | 0,0498 | 0,1492 | 3.276 | 39.312 |
| | 12 mm | 0,0539 | 0,1532 | 1.600 | 19.200 |
| | 14 mm | 0,1005 | 0,2003 | 1.540 | 18.480 |
| | 16 mm | 0,1162 | 0,2475 | 1.080 | 12.960 |
| | 18 mm | 0,1825 | 0,3306 | 720 | 8.640 |
| | 20 mm | 0,6874 | 0,8734 | 490 | 5.880 |
| | 22 mm | 0,8923 | 1,1266 | 336 | 4.032 |
| | 24 mm | 1,0066 | 1,2508 | 240 | 2.880 |
| | 28 mm | 1,2590 | 1,5996 | 120 | 1.440 |
| | 40 mm | 2,4385 | 3,0837 | 50 | 600 |
|  | P.2669 | | | | |
| | 14 mm | 0,1005 | 0,2003 | 1.540 | 18.480 |
| | 18 mm | 0,1825 | 0,3306 | 720 | 8.640 |
| 24 mm | 1,0066 | 1,2508 | 240 | 2.880 | |
|  | P.2665 | | | | |
| | 16 mm | 0,1162 | 0,2475 | 1.080 | 12.960 |
| | 18 mm | 0,1825 | 0,3306 | 720 | 8.640 |
| | 24 mm | 1,0066 | 1,2508 | 240 | 2.880 |
| 40 mm | 2,4385 | 3,0837 | 50 | 600 | |

| | CRYSTAL | CRYSTAL coated | minimum quantity | | |
|---|--|--|--|--|---|
| | CLEAR | AB AFLAME AMBER ANTIQUÉ GOLD SILVER | | | |
| | | BB BW OG OS VL VM | | | |
| inch | EURO piece | EURO piece | BOX pieces | CARTON pieces | |
|  | P.2730 40 mm | 2,4988 | 3,1435 | 50 | 600 |
|  | P.2729 40 mm | 2,4988 | 3,1435 | 50 | 600 |
|  | P.2660 30 mm | 1,1529 | 1,6579 | 240 | 2.880 |
|  | P.2528 15 mm CH: 1,8mm 20 mm CH: 1,8mm 25 mm CH: 1,8mm 30 mm CH: 2,0mm 35 mm CH: 2,0mm 40 mm CH: 3,3mm 50 mm CH: 3,3mm 60 mm CH: 3,3mm 70 mm CH: 3,3mm | 0,1737 0,8747 1,0757 1,0757 1,1529 1,7631 2,1410 4,6945 6,0950 | 0,3331 1,0744 1,4163 1,5807 1,6978 2,3791 3,2370 6,1327 8,5647 | 1.400 980 480 240 140 120 90 49 24 | 16.800 11.760 5.760 2.880 1.680 1.440 1.080 588 288 |
|  | P.6302 20 mm CH: 3,0mm | 0,8506 | 1,1478 | 240 | 2.880 |

| | CRYSTAL | CRYSTAL coated | minimum quantity | |
|------|---------------|--|---------------------|------------------|
| | CLEAR | AB AFLAME AMBER ANTIQUÉ GOLD SILVER | | |
| | | BB BW OG OS VL VM | | |
| inch | EURO piece | EURO piece | BOX pieces | CARTON pieces |

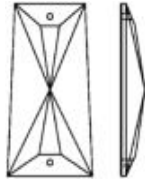

P.0115

| | | | | |
|-------------|--------|--------|-----|-------|
| 46x15x13 mm | 1,6361 | 2,1917 | 160 | 1.920 |
| 49x16x15 mm | 2,2745 | 2,8300 | 160 | 1.920 |
| 55x20x18 mm | 2,2881 | 3,2308 | 90 | 1.080 |
| 57x21x20 mm | 2,3058 | 3,2485 | 72 | 864 |
| 58x25x22 mm | 3,6461 | 4,5888 | 72 | 864 |
| 63x27x25 mm | 3,6638 | 4,6890 | 60 | 720 |
| 64x29x27 mm | 3,7884 | 4,8136 | 60 | 720 |
| 65x30x27 mm | 3,8310 | 4,8562 | 60 | 720 |
| 67x33x30 mm | 6,2839 | 7,6934 | 60 | 720 |



P.0100

| | | | | | |
|-----------|------|--------|--------|-----|-------|
| 63x18 mm | 2.5" | 2,6363 | 3,3998 | 144 | 1.728 |
| 76x20 mm | 3" | 3,2835 | 4,1422 | 108 | 1.296 |
| 100x20 mm | 4" | 4,7813 | 5,8894 | 80 | 960 |
| 125x23 mm | 5" | 6,9400 | 8,6023 | 48 | 576 |

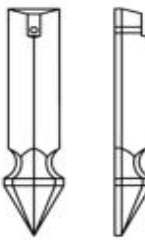

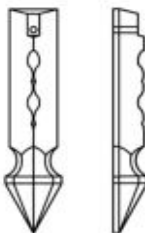

P.0134

| | | | | | |
|-----------|------|---------|---------|-----|-------|
| 63x14 mm | 2.5" | 2,4747 | 3,1728 | 112 | 1.344 |
| 76x15 mm | 3" | 2,9378 | 3,7800 | 98 | 1.176 |
| 100x16 mm | 4" | 3,7393 | 4,8474 | 84 | 1.008 |
| 125x17 mm | 5" | 6,0717 | 7,2441 | 48 | 576 |
| 150x18 mm | 6" | 12,1747 | 13,4976 | 36 | 432 |

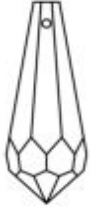
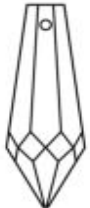

P.0137

| | | | | | |
|-----------|------|---------|---------|-----|-------|
| 63x14 mm | 2.5" | 2,4747 | 3,1728 | 112 | 1.344 |
| 76x15 mm | 3" | 3,6461 | 4,4884 | 98 | 1.176 |
| 100x16 mm | 4" | 4,7861 | 5,8942 | 84 | 1.008 |
| 125x17 mm | 5" | 12,3677 | 13,5401 | 48 | 576 |
| 150x18 mm | 6" | 12,4827 | 13,8055 | 36 | 432 |

| | | | CRYSTAL | CRYSTAL coated | minimum quantity | |
|---|---------------|-------|---------------|--|---------------------|------------------|
| | | | CLEAR | AB AFLAME AMBER ANTIQUÉ GOLD SILVER | | |
| | | | | BB BW OG OS VL VM | | |
| | | inch | EURO piece | EURO piece | BOX pieces | CARTON pieces |
|  | P.1381 | | | | | |
| | 28x12 mm | 1.1" | 1,0519 | 1,0932 | 490 | 5.880 |
| | 32x14 mm | 1.25" | 0,5708 | 0,8429 | 360 | 4.320 |
| | 38x15 mm | 1.5" | 0,6713 | 0,9434 | 360 | 4.320 |
| | 45x18 mm | 1.75" | 1,5437 | 1,9713 | 150 | 1.800 |
|  | P.1685 | | | | | |
| | 38x14 mm | 1.5" | 1,9987 | 2,2708 | 360 | 4.320 |
|  | P.1081 | | | | | |
| | 38x16 mm | 1.5" | 2,1362 | 2,5276 | 150 | 1.800 |
| | 50x18 mm | 2" | 6,0347 | 6,4624 | 150 | 1.800 |
| | 63x20 mm | 2.5" | 6,3145 | 6,8013 | 64 | 768 |
|  | P.2679 | | | | | |
| | 50x11 mm | 2" | 2,5816 | 2,8739 | 210 | 2.520 |
| | 63x11 mm | 2.5" | 2,9796 | 3,3322 | 128 | 1.536 |
| | 76x12 mm | 3" | 5,3151 | 5,9545 | 128 | 1.536 |
|  | P.1182 | | | | | |
| | 38x14 mm | 1.5" | 0,9190 | 1,1910 | 360 | 4.320 |

| inch | CRYSTAL | CRYSTAL coated | minimum quantity | CARTON pieces |
|------|---------------|--|---------------------|------------------|
| | CLEAR | AB AFLAME AMBER ANTIQUÉ GOLD SILVER | | |
| | EURO piece | EURO piece | BOX pieces | |



P.2616

20 mm
30 mm
40 mm
50 mm
60 mm
70 mm

| | | | |
|----------|----------|-----|-------|
| 1,1593 | 1,4625 | 260 | 3.120 |
| 1,3700 | 1,8752 | 90 | 1.080 |
| 1,8596 | 2,4758 | 40 | 480 |
| 7,8839 | 8,8648 | 12 | 144 |
| 69,4217 | 70,8588 | 4 | 48 |
| 149,1111 | 151,5810 | 1 | 12 |



P.2602

40 mm

| | | | |
|--------|--------|----|-----|
| 3,7691 | 4,4717 | 40 | 480 |
|--------|--------|----|-----|



P.2626

30 mm
40 mm
50 mm

| | | | |
|---------|---------|----|-------|
| 2,8791 | 3,3729 | 96 | 1.152 |
| 5,1801 | 5,8833 | 40 | 480 |
| 13,7674 | 14,7044 | 20 | 240 |

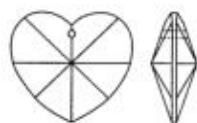

P.2718

40 mm

| | | | |
|--------|--------|----|-----|
| 2,6419 | 3,3114 | 50 | 600 |
|--------|--------|----|-----|

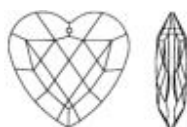

P.2727

40 mm

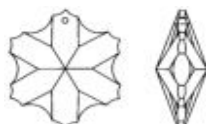

| | | | |
|--------|--------|----|-----|
| 2,6419 | 3,3114 | 50 | 600 |
|--------|--------|----|-----|







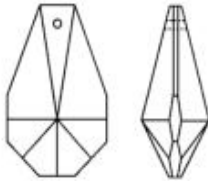

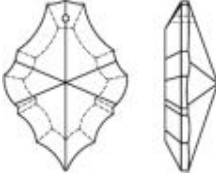
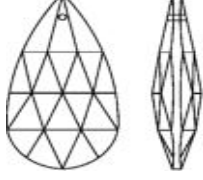
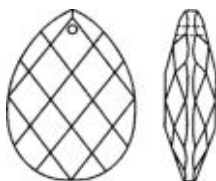

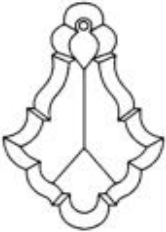
P.2724

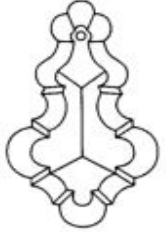
45 mm

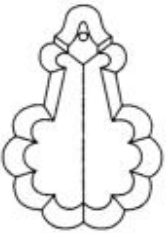
| | | | |
|--------|--------|----|-----|
| 2,9812 | 3,8165 | 50 | 600 |
|--------|--------|----|-----|

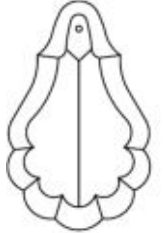
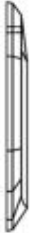
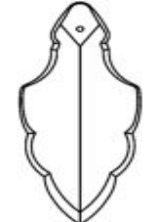
| | | CRYSTAL | CRYSTAL coated | minimum quantity | | |
|---|---------------|---------------|--|---------------------|------------------|-------|
| | | CLEAR | AB AFLAME AMBER ANTIQUÉ GOLD SILVER | | | |
| | | | BB BW OG OS VL VM | | | |
| | inch | EURO piece | EURO piece | BOX pieces | CARTON pieces | |
|  | P.2593 | | | | | |
| | 50x30 mm | 2" | 2,3364 | 3,0849 | 70 | 840 |
| | 76x46 mm | 3" | 12,5237 | 13,9410 | 15 | 180 |
| | 89x54 mm | 3.5" | 17,1755 | 21,1630 | 15 | 180 |
|  | P.2697 | | | | | |
| | 50x34 mm | 2" | 2,8421 | 3,5476 | 96 | 1.152 |
| | 60x41 mm | 2.5" | 3,6364 | 4,6375 | 72 | 864 |
|  | P.2594 | | | | | |
| | 50x35 mm | 2" | 4,7041 | 5,1380 | 80 | 960 |
|  | P.2662 | | | | | |
| | 25x13 mm | 1" | 2,0534 | 2,2904 | 432 | 5.184 |
| | 50x27 mm | 2" | 2,9747 | 3,5876 | 96 | 1.152 |
| | 63x33 mm | 2.5" | 3,8550 | 5,1245 | 63 | 756 |
| | 76x39 mm | 3" | 20,4285 | 21,8395 | 24 | 288 |
| | 89x44 mm | 3.5" | 24,7852 | 27,3260 | 20 | 240 |
| | 100x50 mm | 4" | 34,8857 | 39,2636 | 12 | 144 |
| 115x56 mm | 4.5" | 38,1525 | 44,0712 | 9 | 108 | |
| | 125x61 mm | 5" | 51,0675 | 57,2741 | 9 | 108 |
|  | P.2661 | | | | | |
| | 28x18 mm | 1" | 2,1643 | 2,4083 | 252 | 3.024 |
| | 38x25 mm | 1.5" | 2,1643 | 2,4083 | 147 | 1.764 |
| | 50x33 mm | 2" | 4,5723 | 5,3200 | 96 | 1.152 |
| | 63x41 mm | 2.5" | 4,9686 | 5,9604 | 63 | 756 |
| | 76x50 mm | 3" | 12,8509 | 14,3866 | 15 | 180 |
| | 89x58 mm | 3.5" | 17,1096 | 19,6501 | 15 | 180 |
| | 100x68 mm | 4" | 37,8002 | 42,2632 | 16 | 192 |
| | 115x76 mm | 4.5" | 43,7078 | 48,7996 | 9 | 108 |
| 125x84 mm | 5" | 65,7652 | 72,6541 | 6 | 72 | |

| | | CRYSTAL | CRYSTAL coated | minimum quantity | | |
|---|---|---------------|--|---------------------|------------------|-----------|
| | | CLEAR | AB AFLAME AMBER ANTIQUÉ GOLD SILVER | | | |
| | | | BB BW OG OS VL VM | | | |
| inch | | EURO piece | EURO piece | BOX pieces | CARTON pieces | |
|  |  | P.1001 | | | | |
| | | 50x34 mm | 2" | 3,8157 | 4,5634 | 144 1.728 |
| | | 63x42 mm | 2.5" | 4,3021 | 5,2997 | 120 1.440 |
| | | 76x48 mm | 3" | 6,1022 | 7,6900 | 80 960 |
| | | 89x49 mm | 3.5" | 6,2253 | 8,8649 | 60 720 |
| | | 100x69 mm | 4" | 15,1583 | 18,7134 | 36 432 |
| | | 115x71 mm | 4.5" | 15,4293 | 21,1683 | 36 432 |
| | | 125x79 mm | 5" | 16,8861 | 23,2770 | 24 288 |
|  |  | P.1006 | | | | |
| | | 50x33 mm | 2" | 3,5424 | 4,2901 | 144 1.728 |
| | | 63x39 mm | 2.5" | 4,6133 | 5,6109 | 100 1.200 |
| | | 76x48 mm | 3" | 5,8482 | 7,4359 | 80 960 |
| | | 89x52 mm | 3.5" | 9,6301 | 12,2698 | 60 720 |
| | | 100x60 mm | 4" | 11,7800 | 15,3351 | 40 480 |
| | | 115x68 mm | 4.5" | 13,3453 | 19,0844 | 28 336 |
| | | 125x77 mm | 5" | 17,3403 | 23,7313 | 24 288 |
|  |  | P.1002 | | | | |
| | | 50x35 mm | 2" | 4,0376 | 4,7853 | 144 1.728 |
| | | 63x40 mm | 2.5" | 4,1188 | 5,1164 | 120 1.440 |
| | | 76x48 mm | 3" | 4,9421 | 6,5298 | 80 960 |
| | | 89x53 mm | 3.5" | 6,2598 | 8,8995 | 60 720 |
| | | 100x65 mm | 4" | 11,9448 | 15,4999 | 40 480 |
| | | 115x69 mm | 4.5" | 14,9099 | 20,6489 | 36 432 |
| | | 125x75 mm | 5" | 17,6804 | 24,0714 | 24 288 |
|  |  | P.1003 | | | | |
| | | 76x48 mm | 3" | 5,1061 | 6,6939 | 80 960 |
| | | 100x66 mm | 4" | 12,4803 | 16,0353 | 36 432 |
| | | 125x76 mm | 5" | 16,1046 | 22,4955 | 24 288 |
|  |  | P.2074 | | | | |
| | | 76x31 mm | 3" | 6,0492 | 7,4315 | 80 960 |
| | | 100x45 mm | 4" | 10,0088 | 14,4719 | 50 600 |

| | CRYSTAL | CRYSTAL coated | minimum quantity | |
|------|------------|--|------------------|---------------|
| | CLEAR | AB AFLAME AMBER ANTIQUÉ GOLD SILVER | | |
| | | BB BW OG OS VL VM | | |
| inch | EURO piece | EURO piece | BOX pieces | CARTON pieces |

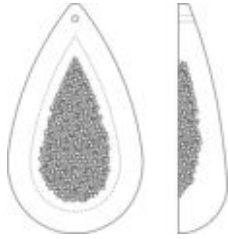

P.0968-99636

| | | | | | |
|-----------|------|---------|--|----|-----|
| 70x40 mm | 2.8" | 27,6597 | | 24 | 288 |
| 90x50 mm | 3.5" | 31,6543 | | 15 | 180 |
| 120x70 mm | 4.7" | 36,1486 | | 9 | 108 |

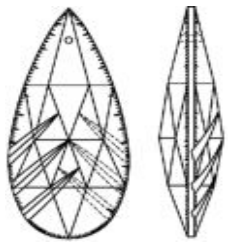

P.0968-99638

| | | | | | |
|----------|------|---------|---------|----|-----|
| 76x39 mm | 3" | 20,7724 | 22,1835 | 28 | 336 |
| 89x44 mm | 3.5" | 28,5112 | 31,0520 | 24 | 288 |

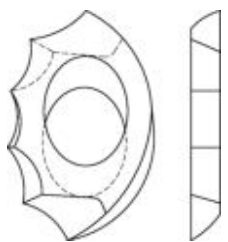

P.0968-99637

| | | | | | |
|----------------------|------|--------|--------|-----|-------|
| 35x22 mm CH: 18/12mm | 1.4" | 3,2463 | 3,7019 | 240 | 2.880 |
| 50x34 mm CH: 23/14mm | 2" | 6,4906 | 7,1757 | 120 | 1.440 |



P.0499-11001

| | | | | | |
|-----------------|-----|---------|--|----|-----|
| 500 mm (Ø 8mm) | 20" | 48,8267 | | 14 | 168 |
| 750 mm (Ø 8mm) | 30" | 68,4154 | | 7 | 84 |
| 1000 mm (Ø 8mm) | 40" | 85,7194 | | 7 | 84 |

end-piece (to fix together) :







- a) ring-connection
- b) plug-connection
- c) magnet-connection

silver-color :

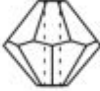
- .../01
- .../11
- .../21

gold-color :

- .../02
- .../12
- .../22

| | | CRYSTAL | CRYSTAL coated | minimum quantity | |
|------|---|----------------------------|--|---------------------|------------------|
| | | CLEAR | AB AFLAME AMBER ANTIQUÉ GOLD SILVER | | |
| | | | BB BW OG OS VL VM | | |
| inch | | EURO piece | EURO piece | BOX pieces | CARTON pieces |
| |  | <u>P.0451-69302</u> | | | |
| | 3 mm | 0,0261 | 0,1768 | 1.440 | 72.000 |
| | 4 mm | 0,0261 | 0,1768 | 720 | 28.800 |
| | 5 mm | 0,0328 | 0,1835 | 576 | 14.400 |
| | 6 mm | 0,0438 | 0,1945 | 288 | 8.640 |
| |  | <u>P.0451-52301</u> | | | |
| | 6x15 mm | 0,3812 | 0,5505 | 72 | 1.440 |
| |  | <u>P.0451-29901</u> | | | |
| | 7x10.5 mm | 0,3314 | 0,4820 | 144 | 2.304 |
| |  | <u>P.0451-55001</u> | | | |
| | 7x10.5 mm | 0,3468 | 0,4975 | 144 | 2.304 |
| | 9x13.5 mm | 0,5183 | 0,6690 | 144 | 1.152 |
| |  | <u>P.0451-19002</u> | | | |
| | 6 mm | 0,1702 | 0,3208 | 288 | 10.080 |
| | 8 mm | 0,2693 | 0,4200 | 144 | 2.304 |
| |  | <u>P.0451-19602</u> | | | |
| | 3 mm | 0,0706 | 0,2212 | 720 | 37.440 |
| | 4 mm | 0,0752 | 0,2258 | 720 | 37.440 |
| | 5 mm | 0,0911 | 0,2418 | 576 | 14.400 |
| | 6 mm | 0,1131 | 0,2638 | 288 | 7.200 |



ROCKCRYSTAL



ROCKCRYSTAL

quartz crystal

elemental brilliance

hand-cut

unique inclusions by nature

pinning service available

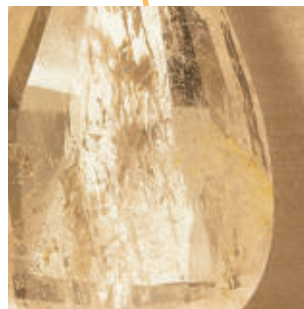
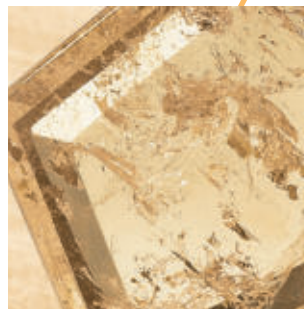

Schöler & Co. GmbH

Gablonzer Strasse 54-61
A-4550 Kremsmünster
Austria

T: ++43-75 83-77 23

F: ++43-75 83-78 12

E: office@scholer-crystal.at

W: www.scholer-crystal.at















ARTICLE INDEX

| Article: | Page: |
|-----------------|--------------|
| R.7000 | 11 |
| R.7010 | 11 |
| R.7080 | 11 |
| R.7090 | 11 |
| R.7100 | 7 |
| R.7150 | 7 |
| R.7200 | 7 |
| R.7250 | 7 |
| R.7300 | 8 |
| R.7350 | 8 |
| R.7400 | 8 |
| R.7500 | 9 |
| R.7600 | 9 |
| R.7650 | 9 |
| R.7700 | 10 |
| R.7800 | 10 |
| R.7900 | 10 |
| R.7910 | 10 |
| R.7950 | 8 |
| R.7960 | 9 |
| R.7991 | 12 |
| R.7995 | 12 |

PRODUCT GROUP

Page:

| | | |
|------------------|---|----|
| OCTAGONS |  | 7 |
| OVALS |  | 7 |
| BEADS |  | 7 |
| BALLS |  | 8 |
| FINIALS |  | 8 |
| ICICLES |  | 8 |
| STARS |  | 8 |
| ALMONDS |  | 9 |
| PENDELOQUES |  | 10 |
| ROSETTES & STARS |  | 11 |
| CENTERPIECES |  | 11 |
| BOBECHES |  | 11 |
| IRREGULAR SHAPES |  | 12 |

| ROCKCRYSTAL | AMETHYST EMERALD ROSALIN SMOKE | minimum quantity | | | |
|---------------|---|---------------------|---------------|------------------|--|
| EURO piece | EURO piece | BAG pieces | BOX pieces | CARTON pieces | |

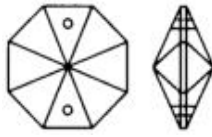

R.7100

| | | | | | |
|-------|---------|---------|---|-----|-------|
| 12 mm | 5,2174 | 14,3486 | 1 | 100 | 1.200 |
| 14 mm | 5,2174 | 14,3486 | 1 | 100 | 1.200 |
| 16 mm | 5,2174 | 14,3486 | 1 | 80 | 960 |
| 18 mm | 5,2174 | 14,3486 | 1 | 80 | 960 |
| 20 mm | 5,3750 | 14,7796 | 1 | 60 | 720 |
| 22 mm | 5,4521 | 14,9933 | 1 | 60 | 720 |
| 24 mm | 5,7254 | 15,7467 | 1 | 50 | 600 |
| 26 mm | 5,8936 | 16,2057 | 1 | 50 | 600 |
| 28 mm | 8,9841 | 24,7063 | 1 | 40 | 480 |
| 30 mm | 10,7816 | 29,6503 | 1 | 40 | 480 |
| 32 mm | 10,9428 | 30,0918 | 1 | 40 | 480 |

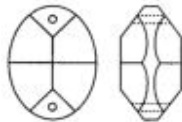

R.7150

| | | | | | |
|-------|---------|---------|---|----|-----|
| 20 mm | 7,4143 | 14,8287 | 1 | 60 | 720 |
| 24 mm | 9,3030 | 18,6059 | 1 | 50 | 600 |
| 28 mm | 10,0072 | 20,0145 | 1 | 40 | 480 |
| 32 mm | 11,5350 | 23,0699 | 1 | 40 | 480 |
| 36 mm | 15,5680 | 31,1360 | 1 | 40 | 480 |
| 40 mm | 18,6830 | 37,3625 | 1 | 40 | 480 |



R.7200

| | | | | | |
|-------|---------|---------|---|-----|-------|
| 6 mm | 2,8432 | 4,2608 | 1 | 100 | 1.200 |
| 8 mm | 3,4118 | 5,1178 | 1 | 100 | 1.200 |
| 10 mm | 4,2848 | 6,4232 | 1 | 50 | 600 |
| 12 mm | 5,3560 | 8,0340 | 1 | 50 | 600 |
| 14 mm | 7,4984 | 11,2476 | 1 | 50 | 600 |
| 16 mm | 9,7480 | 14,6219 | 1 | 50 | 600 |
| 18 mm | 10,5854 | 15,8763 | 1 | 40 | 480 |
| 20 mm | 11,4649 | 17,1973 | 1 | 40 | 480 |
| 25 mm | 13,5462 | 20,3193 | 1 | 40 | 480 |



R.7250

| | | | | | |
|-------|--------|---------|---|----|-----|
| 20 mm | 7,2251 | 14,4502 | 1 | 40 | 480 |
| 25 mm | 8,5917 | 17,1833 | 1 | 40 | 480 |

| ROCKCRYSTAL | AMETHYST EMERALD ROSALIN SMOKE | minimum quantity | | |
|---------------|---|---------------------|---------------|------------------|
| EURO piece | EURO piece | BAG pieces | BOX pieces | CARTON pieces |



R.7400

| | | | | | |
|--------|----------|----------|---|----|-----|
| 38 mm | 21,7174 | 39,0899 | 1 | 20 | 240 |
| 50 mm | 27,6426 | 49,8715 | 1 | 10 | 120 |
| 63 mm | 51,5604 | 90,2334 | 1 | 5 | 60 |
| 76 mm | 75,1770 | 135,3186 | 1 | 1 | 36 |
| 89 mm | 139,2009 | 208,8032 | 1 | 1 | 27 |
| 100 mm | 239,2594 | 358,8873 | 1 | 1 | 27 |

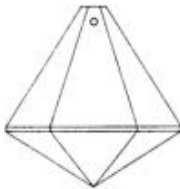

R.7350

| | | | | | |
|-------|---------|---------|---|----|-----|
| 30 mm | 15,5435 | 23,3152 | 1 | 20 | 240 |
| 40 mm | 21,4511 | 32,1767 | 1 | 10 | 120 |

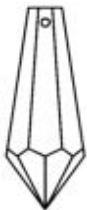

R.7300

| | | | | | |
|-----------|---------|---------|---|----|-----|
| 38x14 mm | 11,2652 | 16,8960 | 1 | 50 | 600 |
| 50x16 mm | 13,4061 | 20,1091 | 1 | 40 | 480 |
| 63x18 mm | 16,9801 | 25,4666 | 1 | 35 | 420 |
| 76x20 mm | 22,3481 | 33,5187 | 1 | 30 | 360 |
| 89x22 mm | 27,9019 | 41,8510 | 1 | 25 | 300 |
| 100x24 mm | 31,2832 | 46,9247 | 1 | 25 | 300 |



R.7950

| | | | | | |
|-------|---------|---------|---|----|-----|
| 30 mm | 16,9801 | 25,4701 | 1 | 40 | 480 |
| 40 mm | 21,8435 | 32,7653 | 1 | 30 | 360 |

| ROCKCRYSTAL | AMETHYST EMERALD ROSALIN SMOKE | minimum quantity | | | |
|---------------|---|---------------------|---------------|------------------|--|
| EURO piece | EURO piece | BAG pieces | BOX pieces | CARTON pieces | |

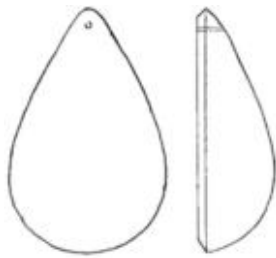

R.7500

| | | | | | |
|-----------|---------|---------|---|----|-----|
| 38x22 mm | 11,1806 | 16,6297 | 1 | 40 | 480 |
| 50x29 mm | 12,0215 | 17,8806 | 1 | 40 | 480 |
| 63x37 mm | 13,7274 | 21,6228 | 1 | 25 | 300 |
| 76x44 mm | 14,5283 | 24,0826 | 1 | 25 | 300 |
| 89x52 mm | 17,0186 | 31,4829 | 1 | 15 | 180 |
| 100x58 mm | 23,7076 | 45,0431 | 1 | 15 | 180 |
| 125x74 mm | 47,2917 | 61,4659 | 1 | 10 | 120 |

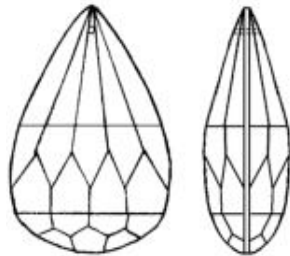

R.7600

| | | | | | |
|-----------|---------|---------|---|----|-----|
| 38x22 mm | 12,1308 | 19,1059 | 1 | 40 | 480 |
| 50x29 mm | 13,0439 | 21,6852 | 1 | 40 | 480 |
| 63x37 mm | 16,0304 | 26,6506 | 1 | 25 | 300 |
| 76x44 mm | 21,2186 | 35,2759 | 1 | 25 | 300 |
| 89x52 mm | 23,7136 | 45,0557 | 1 | 15 | 180 |
| 100x58 mm | 32,7156 | 62,1557 | 1 | 15 | 180 |
| 125x74 mm | 55,6294 | 82,6342 | 1 | 10 | 120 |

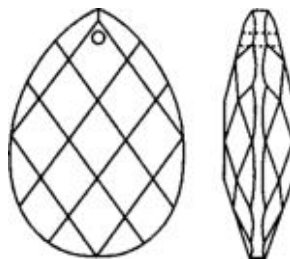

R.7650

| | | | | | |
|-----------|---------|---------|---|----|-----|
| 38x27 mm | 12,5161 | 18,7706 | 1 | 45 | 540 |
| 50x35 mm | 13,4061 | 20,1091 | 1 | 45 | 540 |
| 63x43 mm | 17,6358 | 21,7174 | 1 | 30 | 360 |
| 76x52 mm | 25,4806 | 38,2210 | 1 | 30 | 360 |
| 89x62 mm | 30,2004 | 45,2989 | 1 | 20 | 240 |
| 100x70 mm | 40,8489 | 61,2769 | 1 | 20 | 240 |
| 125x88 mm | 65,9015 | 85,6787 | 1 | 10 | 120 |

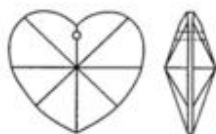

R.7960

| | | | | | |
|-------|---------|---------|---|----|-----|
| 30 mm | 16,9801 | 25,4701 | 1 | 40 | 480 |
| 40 mm | 21,8435 | 32,7653 | 1 | 30 | 360 |

| ROCKCRYSTAL | AMETHYST EMERALD ROSALIN SMOKE | minimum quantity | | |
|---------------|---|---------------------|---------------|------------------|
| EURO piece | EURO piece | BAG pieces | BOX pieces | CARTON pieces |



R.7700

| | | | | | |
|-----------|---------|---------|---|----|-----|
| 38x27 mm | 12,5161 | 18,7706 | 1 | 45 | 540 |
| 50x35 mm | 13,4061 | 20,1091 | 1 | 45 | 540 |
| 63x43 mm | 17,6358 | 21,7174 | 1 | 30 | 360 |
| 76x52 mm | 25,4806 | 38,2210 | 1 | 30 | 360 |
| 89x62 mm | 30,2004 | 45,2989 | 1 | 20 | 240 |
| 100x70 mm | 40,8489 | 61,2769 | 1 | 20 | 240 |
| 125x88 mm | 65,9015 | 85,6787 | 1 | 10 | 120 |

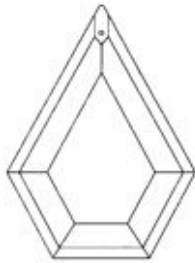

R.7800

| | | | | | |
|-----------|---------|---------|---|----|-----|
| 38x27 mm | 12,5161 | 18,7706 | 1 | 45 | 540 |
| 50x35 mm | 13,4061 | 20,1091 | 1 | 45 | 540 |
| 63x43 mm | 17,6358 | 21,7174 | 1 | 30 | 360 |
| 76x52 mm | 25,4806 | 38,2210 | 1 | 30 | 360 |
| 89x62 mm | 30,2004 | 45,2989 | 1 | 20 | 240 |
| 100x70 mm | 40,8489 | 61,2769 | 1 | 20 | 240 |
| 125x88 mm | 65,9015 | 85,6787 | 1 | 10 | 120 |

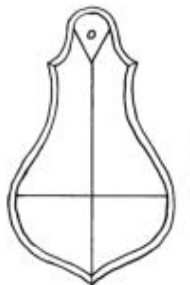

R.7900

| | | | | | |
|-----------|---------|---------|---|----|-----|
| 50x29 mm | 23,4624 | 35,1936 | 1 | 35 | 420 |
| 76x44 mm | 30,1654 | 45,2463 | 1 | 25 | 300 |
| 100x58 mm | 40,2217 | 60,3308 | 1 | 15 | 180 |
| 125x74 mm | 53,7364 | 80,6046 | 1 | 10 | 120 |

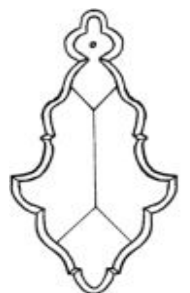

R.7910

| | | | | | |
|-----------|---------|---------|---|----|-----|
| 50x29 mm | 27,1730 | 40,7578 | 1 | 35 | 420 |
| 76x44 mm | 35,7542 | 53,6313 | 1 | 25 | 300 |
| 100x58 mm | 50,0538 | 75,0789 | 1 | 15 | 180 |
| 125x74 mm | 66,1999 | 99,2981 | 1 | 10 | 120 |

| ROCKCRYSTAL | AMETHYST EMERALD ROSALIN SMOKE | minimum quantity | | | |
|---------------|---|---------------------|---------------|------------------|--|
| EURO piece | EURO piece | BAG pieces | BOX pieces | CARTON pieces | |



R.7090

center hole: 2 mm

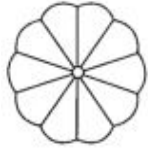

| | | | | | |
|-------|---------|---------|---|----|-----|
| 20 mm | 10,7080 | 16,0621 | 1 | 60 | 720 |
| 30 mm | 11,8994 | 17,8491 | 1 | 40 | 480 |
| 40 mm | 17,5617 | 26,3426 | 1 | 20 | 240 |
| 50 mm | 23,5675 | 35,3512 | 1 | 10 | 120 |



R.7080

center hole: 2 mm



| | | | | | |
|-------|---------|---------|---|----|-----|
| 20 mm | 11,7662 | 17,6493 | 1 | 60 | 720 |
| 30 mm | 13,2204 | 19,8288 | 1 | 40 | 480 |
| 40 mm | 19,5134 | 29,2719 | 1 | 20 | 240 |
| 50 mm | 26,1884 | 39,2826 | 1 | 10 | 120 |

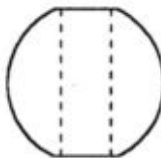

R.7010

center hole: 13 mm

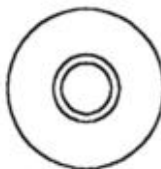

| | | | | | |
|--------|----------|----------|---|----|-----|
| 50 mm | 39,7171 | 79,4343 | 1 | 10 | 120 |
| 76 mm | 89,3885 | 172,0714 | 1 | 1 | 36 |
| 100 mm | 201,0559 | 327,7233 | 1 | 1 | 27 |

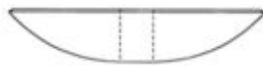

R.7000

center hole: 11 mm



| | | | | | |
|-----------|---------|----------|---|----|-----|
| 50x15 mm | 24,1071 | 39,2791 | 1 | 20 | 240 |
| 76x18 mm | 48,6276 | 106,9822 | 1 | 12 | 144 |
| 100x20 mm | 72,6962 | 218,0886 | 1 | 9 | 108 |

| ROCKCRYSTAL | AMETHYST EMERALD ROSALIN SMOKE | minimum quantity | | |
|---------------|---|---------------------|---------------|------------------|
| EURO piece | EURO piece | BAG pieces | BOX pieces | CARTON pieces |



top-hole

R.7991

tumbled irregular shapes with 2.0mm top-hole (TH) or 2.0mm center-hole (CH)

EURO / kg

| | | | | |
|-------------|----------|---|----|-----|
| 40-50 mm TH | 104,2218 | 1 | 24 | 288 |
| 40-50 mm CH | 104,2218 | 1 | 24 | 288 |

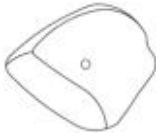

center-hole

(1 BOX = 24 pieces = approx. 2.32 kg)



top-hole

R.7995

natural irregular shapes with 2.0mm top-hole (TH) or 2.0mm center-hole (CH)

EURO / piece

| | | | | |
|----------|--------|---|-----|-------|
| 30 mm TH | 2,4727 | 1 | 100 | 1.200 |
| 30 mm CH | 2,4727 | 1 | 100 | 1.200 |
| 40 mm TH | 2,8683 | 1 | 80 | 960 |
| 40 mm CH | 2,8683 | 1 | 80 | 960 |
| 50 mm TH | 3,6852 | 1 | 60 | 720 |
| 50 mm CH | 3,6852 | 1 | 60 | 720 |
| 60 mm TH | 4,9234 | 1 | 40 | 480 |
| 60 mm CH | 4,9234 | 1 | 40 | 480 |
| 70 mm TH | 6,1359 | 1 | 20 | 240 |
| 70 mm CH | 6,1359 | 1 | 20 | 240 |
| 80 mm TH | 8,8650 | 1 | 20 | 240 |
| 80 mm CH | 8,8650 | 1 | 20 | 240 |



center-hole

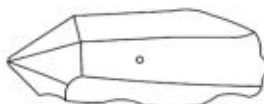
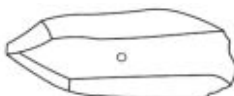

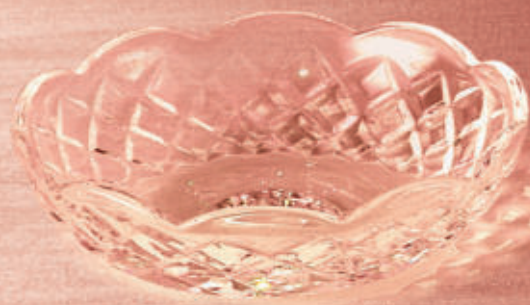

ZIP



ZIP

fine crystal

premium quality

lamp-parts & accessories

pinning-material

fast pinning service



Schöler & Co. GmbH

Gablonzer Strasse 54-61
A-4550 Kremsmünster
Austria

T: ++43-75 83-77 23

F: ++43-75 83-78 12

E: office@scholer-crystal.at

W: www.scholer-crystal.at









ARTICLE INDEX

| <u>Pinning Service:</u> | <u>Page:</u> | <u>Article:</u> | <u>Page:</u> | <u>Article:</u> | <u>Page:</u> | <u>Article:</u> | <u>Page:</u> |
|----------------------------------|--------------|-----------------|--------------|-----------------|--------------|-----------------|--------------|
| BEAD_PINNING | 76 | Z.9090 | 58 | Z.9330 | 10 | Z.9650 | 17 |
| | | Z.9095 | 58 | Z.9340 | 10 | Z.9655 | 17 |
| CONNECTOR_PINNING | 72 | Z.9097 | 58 | Z.9344 | 10 | Z.9658 | 17 |
| | | Z.9098 | 58 | Z.9345 | 10 | Z.9660 | 26 |
| HANGER_INSERTION | 72 | Z.9099 | 59 | Z.9350 | 11 | Z.9663 | 26 |
| | | Z.9100 | 59 | Z.9351 | 11 | Z.9666 | 27 |
| HOOK_INSERTION | 76 | Z.9111 | 70 | Z.9352 | 12 | Z.9667 | 27 |
| | | Z.9112 | 70 | Z.9353 | 12 | Z.9668 | 27 |
| OVAL-RING_PINNING | 74 | Z.9140 | 60 | Z.9355 | 11 | Z.9670 | 24 |
| | | Z.9141 | 61 | Z.9361 | 13 | Z.9672 | 24 |
| OVERLAPPING-RING_PINNING | 74 | Z.9142 | 61 | Z.9362 | 13 | Z.9674 | 24 |
| | | Z.9143 | 61 | Z.9364 | 14 | Z.9675 | 24 |
| PENDANT-FIXING-#1_PINNING | 75 | Z.9144 | 60 | Z.9365 | 14 | Z.9676 | 25 |
| | | Z.9145 | 60 | Z.9366 | 14 | Z.9677 | 25 |
| PENDANT-FIXING-#2_PINNING | 75 | Z.9151 | 62 | Z.9373 | 15 | Z.9680 | 16 |
| | | Z.9152 | 62 | Z.9400 | 33 | Z.9683 | 16 |
| PENDANT-FIXING-#3_PINNING | 75 | Z.9153 | 62 | Z.9402 | 32 | Z.9685 | 16 |
| | | Z.9160 | 62 | Z.9403 | 32 | Z.9688 | 16 |
| PENDANT-FIXING-#4_PINNING | 75 | Z.9164 | 65 | Z.9405 | 33 | Z.9689 | 16 |
| | | Z.9166 | 67 | Z.9406 | 33 | Z.9711 | 54 |
| PLAIN-CLIP_PINNING | 73 | Z.9167 | 67 | Z.9410 | 35 | Z.9712 | 54 |
| | | Z.9170 | 63 | Z.9420 | 34 | Z.9721 | 55 |
| ROUND-RING_PINNING | 74 | Z.9172 | 63 | Z.9430 | 34 | Z.9722 | 55 |
| | | Z.9175 | 63 | Z.9433 | 35 | Z.9723 | 55 |
| SNAKE-CLIP_PINNING | 73 | Z.9177 | 63 | Z.9435 | 37 | Z.9731 | 56 |
| | | Z.9178 | 71 | Z.9436 | 37 | Z.9732 | 56 |
| SQUEEZE-RING_PINNING | 77 | Z.9179 | 71 | Z.9440 | 36 | Z.9733 | 56 |
| | | Z.9180 | 64 | Z.9441 | 36 | Z.9734 | 56 |
| STRUNG_PINNING | 77 | Z.9181 | 64 | Z.9442 | 36 | Z.9761 | 57 |
| | | Z.9182 | 64 | Z.9443 | 36 | Z.9762 | 57 |
| SWAN_PINNING | 76 | Z.9183 | 64 | Z.9444 | 36 | Z.9781 | 57 |
| | | Z.9185 | 64 | Z.9445 | 36 | Z.9782 | 57 |
| SWEDISH-TWIST_PINNING | 77 | Z.9186 | 65 | Z.9446 | 36 | Z.9852 | 7 |
| | | Z.9187 | 65 | Z.9447 | 36 | Z.9853 | 8 |
| TRADITIONAL_PINNING | 76 | Z.9188 | 65 | Z.9448 | 37 | Z.9854 | 9 |
| | | Z.9189 | 65 | Z.9450 | 38 | Z.9855 | 9 |
| WIRE-CLIP_PINNING | 74 | Z.9190 | 66 | Z.9452 | 39 | Z.9856 | 7 |
| | | Z.9191 | 66 | Z.9456 | 40 | Z.9857 | 7 |
| | | Z.9192 | 66 | Z.9457 | 40 | Z.9858 | 8 |
| | | Z.9193 | 70 | Z.9458 | 41 | Z.9859 | 8 |
| | | Z.9194 | 70 | Z.9459 | 41 | Z.9860 | 19 |
| | | Z.9195 | 67 | Z.9460 | 42 | Z.9862 | 20 |
| | | Z.9196 | 68 | Z.9461 | 42 | Z.9863 | 20 |
| | | Z.9197 | 68 | Z.9463 | 43 | Z.9868 | 21 |
| | | Z.9198 | 69 | Z.9464 | 43 | Z.9869 | 21 |
| | | Z.9199 | 68 | Z.9471 | 44 | Z.9870 | 21 |
| | | Z.9240 | 30 | Z.9472 | 44 | Z.9871 | 21 |
| | | Z.9242 | 30 | Z.9490 | 37 | Z.9881 | 22 |
| | | Z.9244 | 31 | Z.9550 | 45 | Z.9882 | 22 |
| | | Z.9250 | 30 | Z.9560 | 45 | Z.9883 | 22 |
| | | Z.9251 | 30 | Z.9570 | 46 | Z.9884 | 23 |
| | | Z.9260 | 31 | Z.9571 | 47 | Z.9885 | 23 |
| | | Z.9261 | 31 | Z.9581 | 48 | Z.9886 | 23 |
| | | Z.9271 | 28 | Z.9582 | 49 | Z.9887 | 23 |
| | | Z.9281 | 28 | Z.9583 | 52 | Z.9888 | 23 |
| | | Z.9290 | 29 | Z.9584 | 52 | Z.9889 | 23 |
| | | Z.9291 | 29 | Z.9586 | 50 | Z.9900 | 59 |
| | | Z.9294 | 29 | Z.9587 | 50 | Z.9903 | 59 |
| | | Z.9295 | 29 | Z.9590 | 51 | Z.9905 | 59 |
| | | Z.9297 | 31 | Z.9591 | 51 | Z.9906 | 59 |
| | | Z.9298 | 28 | Z.9594 | 53 | | |
| | | Z.9299 | 28 | Z.9595 | 53 | | |

PRODUCT GROUP

Page:

| | | |
|---|---|---------|
| BOBECHES + CENTERPIECES |  | 7 - 15 |
| X-PARTS |  | 16 - 17 |
| ARMS-MT |  | 18 - 19 |
| ARMS |  | 20 - 23 |
| RINGS |  | 24 - 25 |
| SLEEVES |  | 26 - 27 |
| BEADS |  | 28 - 31 |
| DROPS & FRUITS & LEAVES & ORNAMENTS & BIRDS |  | 32 - 37 |
| RODS |  | 38 - 53 |
| PLATES |  | 54 - 57 |
| PINNING & CLEANING & GLUEING - ACCESSORIES |  | 58 - 59 |
| PINNING MATERIAL |  | 60 - 71 |
| PINNING SERVICE |  | 72 - 78 |

| | | |
|-------------------|-------------------|----------------------|
| CRYSTAL | minimum quantity | |
| CLEAR | | |
| EURO piece | BOX pieces | CARTON pieces |

BOBECHEs + CENTERPIECES

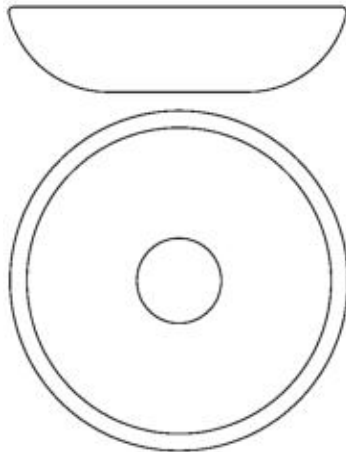

Z.9856 (lead crystal - machine pressed)

center hole: 24 mm

| | | | |
|------------------|--------|---|-----|
| 100x24 mm | 4,0079 | 6 | 108 |
| 100x24 mm - 4 SH | 5,5280 | | |
| 100x24 mm - 5 SH | 5,9080 | | |

drilling of extra SH : | 0,3800

stud-insertion into SH :

| | |
|---------------|--------|
| BRASS | 0,0900 |
| CHROME-PLATED | 0,1000 |
| GOLD-PLATED | 0,1200 |

drilling of bigger CH : | 1,2500

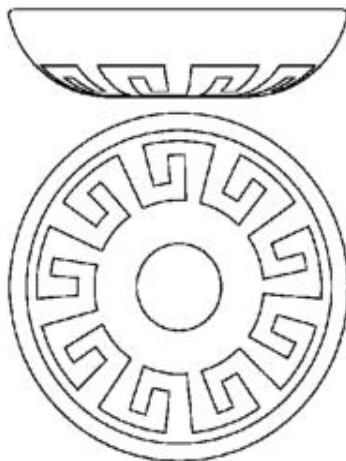

Z.9857 (lead crystal - machine pressed)

center hole: 24 mm

| | | | |
|------------------|--------|---|-----|
| 100x24 mm | 4,0079 | 6 | 108 |
| 100x24 mm - 3 SH | 5,1480 | | |
| 100x24 mm - 9 SH | 7,4280 | | |

drilling of extra SH : | 0,3800

stud-insertion into SH :

| | |
|---------------|--------|
| BRASS | 0,0900 |
| CHROME-PLATED | 0,1000 |
| GOLD-PLATED | 0,1200 |

drilling of bigger CH : | 1,2500

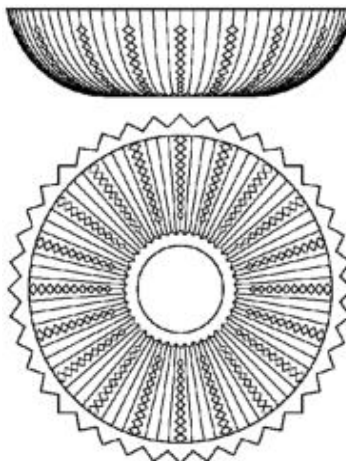

Z.9852 (lead crystal - machine pressed)

center hole: 24 mm

| | | | |
|------------------|--------|---|-----|
| 100x24 mm | 4,0079 | 6 | 108 |
| 100x24 mm - 4 SH | 5,5280 | | |
| 100x24 mm - 5 SH | 5,9080 | | |

drilling of extra SH : | 0,3800

stud-insertion into SH :

| | |
|---------------|--------|
| BRASS | 0,0900 |
| CHROME-PLATED | 0,1000 |
| GOLD-PLATED | 0,1200 |

drilling of bigger CH : | 1,2500

CRYSTAL

minimum
quantity

CLEAR

EURO
piece

BOX
pieces

CARTON
pieces

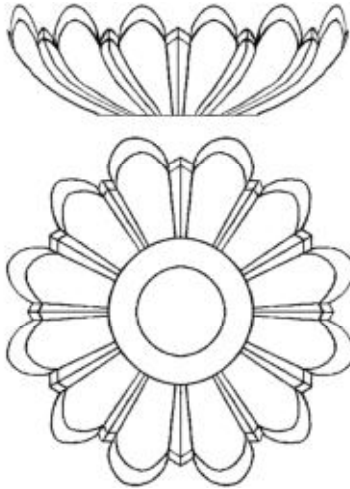

Z.9858 (lead crystal - machine pressed)

center hole: 24 mm

| | | | |
|---------------------------------|--------|---|-----|
| 100x26 mm | 4,0079 | 6 | 108 |
| 100x26 mm - 4 SH | 5,5280 | | |
| 100x26 mm - 6 SH | 6,2880 | | |
| <u>drilling of extra SH :</u> | 0,3800 | | |
| <u>stud-insertion into SH :</u> | | | |
| BRASS | 0,0900 | | |
| CHROME-PLATED | 0,1000 | | |
| GOLD-PLATED | 0,1200 | | |
| <u>drilling of bigger CH :</u> | 1,2500 | | |

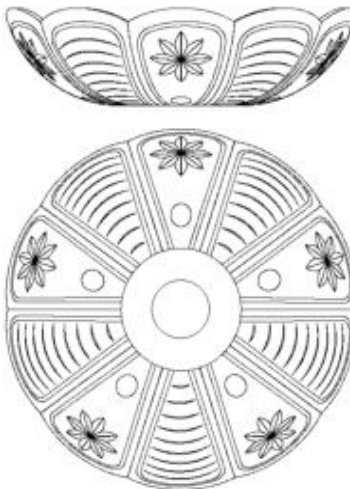

Z.9859 (lead crystal - machine pressed)

center hole: 24 mm

| | | | |
|---------------------------------|--------|---|-----|
| 100x35 mm | 4,0079 | 6 | 108 |
| 100x35 mm - 4 SH | 5,5280 | | |
| 100x35 mm - 5 SH | 5,9080 | | |
| <u>drilling of extra SH :</u> | 0,3800 | | |
| <u>stud-insertion into SH :</u> | | | |
| BRASS | 0,0900 | | |
| CHROME-PLATED | 0,1000 | | |
| GOLD-PLATED | 0,1200 | | |
| <u>drilling of bigger CH :</u> | 1,2500 | | |

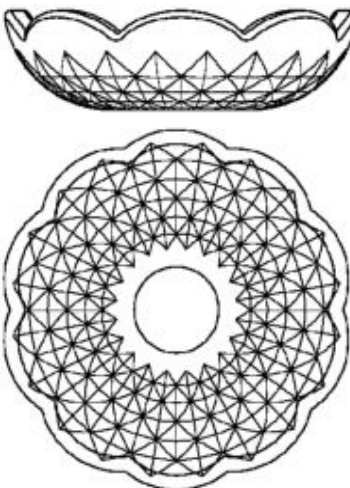

Z.9853 (lead crystal - machine pressed)

center hole: 24 mm

| | | | |
|---------------------------------|--------|---|-----|
| 100x24 mm | 4,0079 | 6 | 108 |
| 100x24 mm - 4 SH | 5,5280 | | |
| 100x24 mm - 5 SH | 5,9080 | | |
| <u>drilling of extra SH :</u> | 0,3800 | | |
| <u>stud-insertion into SH :</u> | | | |
| BRASS | 0,0900 | | |
| CHROME-PLATED | 0,1000 | | |
| GOLD-PLATED | 0,1200 | | |
| <u>drilling of bigger CH :</u> | 1,2500 | | |

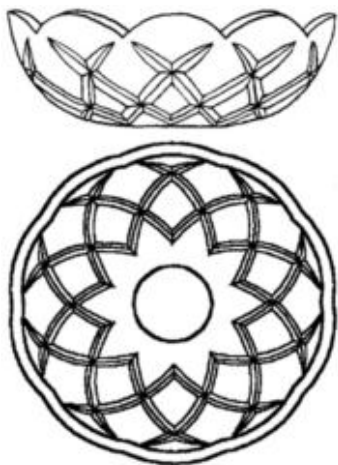
CRYSTALminimum
quantity**CLEAR**EURO
pieceBOX
piecesCARTON
pieces**Z.9854 (lead crystal - machine pressed)**center hole: 24 mm

| | | | |
|------------------|---------|----|-----|
| 80x20 mm | 3,5674 | 10 | 240 |
| 80x20 mm - 5 SH | 5,4674 | | |
| 100x28 mm | 4,0079 | 6 | 108 |
| 100x28 mm - 5 SH | 5,9080 | | |
| 120x32 mm | 4,6578 | 6 | 48 |
| 120x32 mm - 5 SH | 6,5578 | | |
| 150x40 mm | 8,0831 | 1 | 32 |
| 150x40 mm - 5 SH | 9,9831 | | |
| 200x44 mm | 12,9632 | 1 | 7 |
| 200x44 mm - 7 SH | 15,6233 | | |
| 250x52 mm | 22,5369 | 1 | 5 |
| 250x52 mm - 8 SH | 25,5770 | | |
| 300x64 mm | 35,6738 | 1 | 5 |
| 300x64 mm - 9 SH | 39,0938 | | |

drilling of extra SH : | 0,3800 |stud-insertion into SH :

| | |
|---------------|--------|
| BRASS | 0,0900 |
| CHROME-PLATED | 0,1000 |
| GOLD-PLATED | 0,1200 |

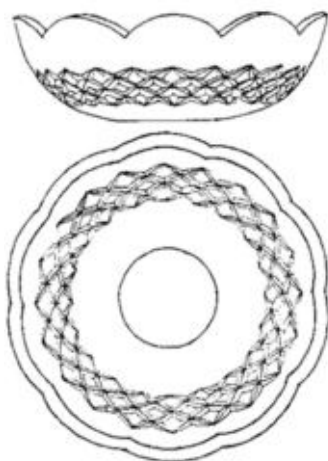
drilling of bigger CH : | 1,2500 |**Z.9855 (lead crystal - hand cut)**center hole: 24 mm

| | | | |
|------------------|---------|----|-----|
| 80x20 mm | 6,4659 | 10 | 240 |
| 80x20 mm - 5 SH | 8,3659 | | |
| 100x28 mm | 6,7831 | 6 | 108 |
| 100x28 mm - 5 SH | 8,6831 | | |
| 120x32 mm | 7,1383 | 6 | 48 |
| 120x32 mm - 5 SH | 9,0384 | | |
| 150x40 mm | 11,6475 | 1 | 32 |
| 150x40 mm - 5 SH | 13,5475 | | |
| 200x44 mm | 21,1203 | 1 | 7 |
| 200x44 mm - 7 SH | 23,7804 | | |
| 250x52 mm | 31,8983 | 1 | 5 |
| 250x52 mm - 8 SH | 34,9383 | | |
| 300x64 mm | 41,9761 | 1 | 5 |
| 300x64 mm - 9 SH | 45,3962 | | |

drilling of extra SH : | 0,3800 |stud-insertion into SH :

| | |
|---------------|--------|
| BRASS | 0,0900 |
| CHROME-PLATED | 0,1000 |
| GOLD-PLATED | 0,1200 |

drilling of bigger CH : | 1,2500 |

CRYSTAL

minimum
quantity

CLEAR

**EURO
piece**

**BOX
pieces**

**CARTON
pieces**



Z.9330 (lead crystal - hand cut)

center hole: 24 mm

| | | | |
|----------|--------|---|-----|
| 22x50 mm | 2,6995 | 6 | 450 |
|----------|--------|---|-----|

| | |
|-------------------------------|--------|
| <u>drilling of extra SH :</u> | 0,3800 |
|-------------------------------|--------|

| | |
|---------------------------------|--------|
| <u>stud-insertion into SH :</u> | |
| BRASS | 0,0900 |
| CHROME-PLATED | 0,1000 |
| GOLD-PLATED | 0,1200 |



Z.9340 (lead crystal - hand cut)

center hole: 24 mm

| | | | |
|----------|---------|---|----|
| 80x70 mm | 10,0370 | 1 | 60 |
|----------|---------|---|----|

| | | | |
|-----------|---------|---|----|
| 100x76 mm | 12,1105 | 1 | 48 |
|-----------|---------|---|----|

| | |
|-------------------------------|--------|
| <u>drilling of extra SH :</u> | 0,3800 |
|-------------------------------|--------|

| | |
|---------------------------------|--------|
| <u>stud-insertion into SH :</u> | |
| BRASS | 0,0900 |
| CHROME-PLATED | 0,1000 |
| GOLD-PLATED | 0,1200 |

80mm-size suitable for 80mm & 100mm bobeches

100mm-size suitable for 120mm & 150mm bobeches



Z.9344 (lead crystal - hand cut)

center hole: 35 mm

| | | | |
|-----------|---------|---|----|
| 210x90 mm | 16,1275 | 1 | 17 |
|-----------|---------|---|----|

| | |
|-------------------------------|--------|
| <u>drilling of extra SH :</u> | 0,3800 |
|-------------------------------|--------|

| | |
|---------------------------------|--------|
| <u>stud-insertion into SH :</u> | |
| BRASS | 0,0900 |
| CHROME-PLATED | 0,1000 |
| GOLD-PLATED | 0,1200 |



Z.9345 (lead crystal - hand cut)

center hole: 35 mm

| | | | |
|-----------|---------|---|----|
| 210x90 mm | 27,8142 | 1 | 17 |
|-----------|---------|---|----|

| | |
|-------------------------------|--------|
| <u>drilling of extra SH :</u> | 0,3800 |
|-------------------------------|--------|

| | |
|---------------------------------|--------|
| <u>stud-insertion into SH :</u> | |
| BRASS | 0,0900 |
| CHROME-PLATED | 0,1000 |
| GOLD-PLATED | 0,1200 |

CRYSTALminimum
quantity**CLEAR**EURO
pieceBOX
piecesCARTON
pieces**Z.9350 (lead crystal - hand cut)**center hole: 24 mm

80x135 mm | 13,9313 | 1 | 16

80x135 mm - 5 SH | 15,8313 | 1 | 16

drilling of extra SH : | 0,3800 |stud-insertion into SH :

BRASS | 0,0900

CHROME-PLATED | 0,1000

GOLD-PLATED | 0,1200

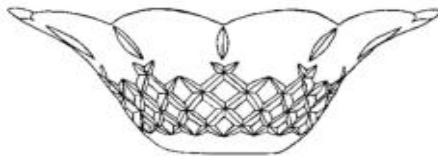
**Z.9351 (lead crystal - hand cut)**center hole: 24 mm

65x170 mm | 21,6559 | 1 | 20

65x170 mm - 5 SH | 23,5559 | 1 | 20

drilling of extra SH : | 0,3800 |stud-insertion into SH :

BRASS | 0,0900

CHROME-PLATED | 0,1000

GOLD-PLATED | 0,1200

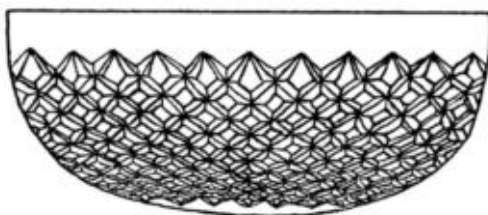
drilling of bigger CH : | 1,2500 |**Z.9355 (lead crystal - hand cut)**center hole: 16 mm

100x200 mm | 35,7209 | 1 | 5

110x250 mm | 47,5538 | 1 | 3

120x300 mm | 64,2546 | 1 | 3

drilling of extra SH : | 0,3800 |stud-insertion into SH :

BRASS | 0,0900

CHROME-PLATED | 0,1000

GOLD-PLATED | 0,1200

drilling of bigger CH : | 1,2500 |

| CRYSTAL CLEAR EURO piece | minimum quantity | BOX pieces | CARTON pieces |
|-----------------------------------|---------------------|---------------|------------------|
|-----------------------------------|---------------------|---------------|------------------|



Z.9352 (lead crystal - hand cut)

center hole: 24 mm

| | | | |
|-----------|---------|---|----|
| 137x60 mm | 12,9701 | 1 | 32 |
|-----------|---------|---|----|

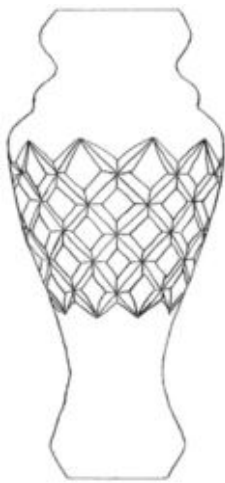

Z.9352 (lead crystal - hand cut)

center hole: 28 mm

| | | | |
|-----------|---------|---|----|
| 200x75 mm | 16,7778 | 1 | 32 |
|-----------|---------|---|----|

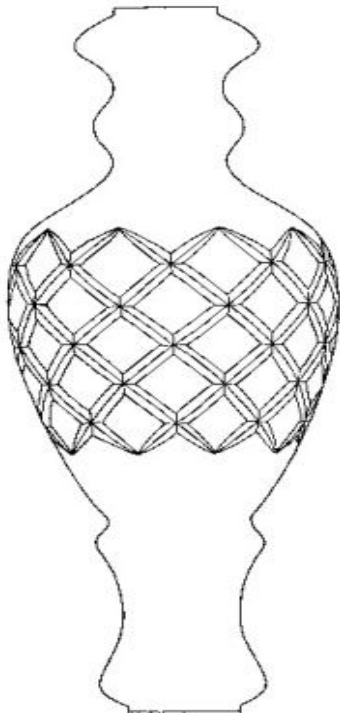

Z.9353 (lead crystal - hand cut)

center hole: 24 mm

| | | | |
|-----------|---------|---|---|
| 257x95 mm | 20,9918 | 1 | 6 |
|-----------|---------|---|---|

| CRYSTAL | minimum quantity | | |
|------------|------------------|--|---------------|
| CLEAR | | | |
| EURO piece | BOX pieces | | CARTON pieces |



Z.9361 (lead crystal - hand cut)

center hole: 16 mm

| | | | |
|-----------|---------|---|----|
| 160x65 mm | 15,6281 | 1 | 17 |
|-----------|---------|---|----|

| | | | |
|--------------------------------|--------|--|--|
| <u>drilling of bigger CH :</u> | 1,2500 | | |
|--------------------------------|--------|--|--|



Z.9361 (lead crystal - hand cut)

center hole: 16 mm

| | | | |
|-----------|---------|---|----|
| 210x65 mm | 15,6281 | 1 | 17 |
|-----------|---------|---|----|

| | | | |
|-------------------------------|--------|--|--|
| <u>drilling of extra SH :</u> | 0,3800 | | |
|-------------------------------|--------|--|--|

| | | | |
|---------------------------------|--------|--|--|
| <u>stud-insertion into SH :</u> | | | |
| BRASS | 0,0900 | | |
| CHROME-PLATED | 0,1000 | | |
| GOLD-PLATED | 0,1200 | | |

| | | | |
|--------------------------------|--------|--|--|
| <u>drilling of bigger CH :</u> | 1,2500 | | |
|--------------------------------|--------|--|--|

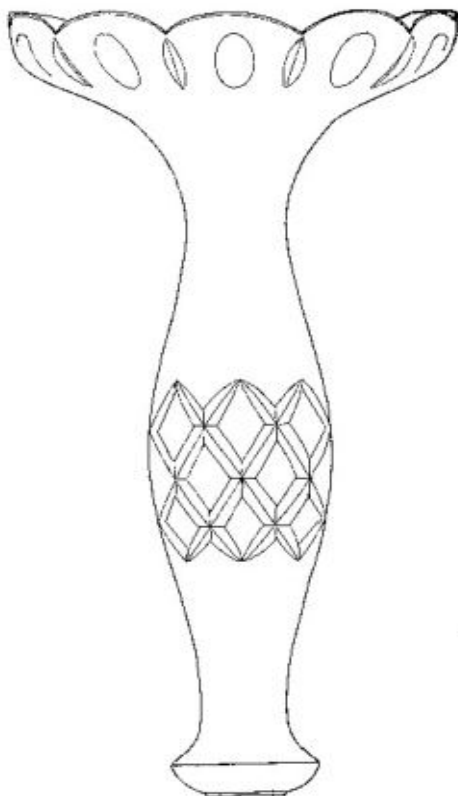

Z.9362 (lead crystal - hand cut)

center hole: 16 mm

| | | | |
|------------|---------|---|---|
| 275x135 mm | 32,6847 | 1 | 4 |
|------------|---------|---|---|

| | | | |
|-------------------|---------|---|---|
| 275x135 mm - 5 SH | 34,5848 | 1 | 4 |
|-------------------|---------|---|---|

| | | | |
|-------------------------------|--------|--|--|
| <u>drilling of extra SH :</u> | 0,3800 | | |
|-------------------------------|--------|--|--|

| | | | |
|---------------------------------|--------|--|--|
| <u>stud-insertion into SH :</u> | | | |
| BRASS | 0,0900 | | |
| CHROME-PLATED | 0,1000 | | |
| GOLD-PLATED | 0,1200 | | |

| | | | |
|--------------------------------|--------|--|--|
| <u>drilling of bigger CH :</u> | 1,2500 | | |
|--------------------------------|--------|--|--|

| CRYSTAL | minimum quantity | | |
|-------------------|-------------------|----------------------|--|
| CLEAR | | | |
| EURO piece | BOX pieces | CARTON pieces | |



Z.9364 (lead crystal - hand cut)

center hole: 24 mm

| | | | |
|----------|--------|---|----|
| 65x60 mm | 8,4019 | 1 | 80 |
|----------|--------|---|----|

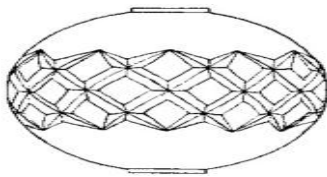

Z.9366 (lead crystal - hand cut)

center hole: 28 mm

| | | | |
|----------|--------|---|----|
| 80x45 mm | 8,0638 | 1 | 72 |
|----------|--------|---|----|

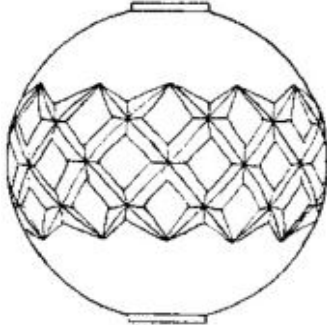

Z.9365 (lead crystal - hand cut)

center hole: 20 mm

| | | | |
|-------|--------|---|----|
| 60 mm | 8,0638 | 1 | 48 |
|-------|--------|---|----|

center hole: 26 mm

| | | | |
|-------|--------|---|----|
| 80 mm | 9,2343 | 1 | 48 |
|-------|--------|---|----|

center hole: 26 mm

| | | | |
|--------|---------|---|----|
| 100 mm | 11,4453 | 1 | 26 |
|--------|---------|---|----|

center hole: 33 mm

| | | | |
|--------|---------|---|---|
| 125 mm | 17,6102 | 1 | 8 |
|--------|---------|---|---|

center hole: 40 mm

| | | | |
|--------|---------|---|---|
| 150 mm | 21,5901 | 1 | 8 |
|--------|---------|---|---|

center hole: 40 mm

| | | | |
|--------|---------|---|---|
| 200 mm | 35,8811 | 1 | 2 |
|--------|---------|---|---|

| CRYSTAL | minimum quantity | |
|------------|------------------|---------------|
| CLEAR | | |
| EURO piece | BOX pieces | CARTON pieces |

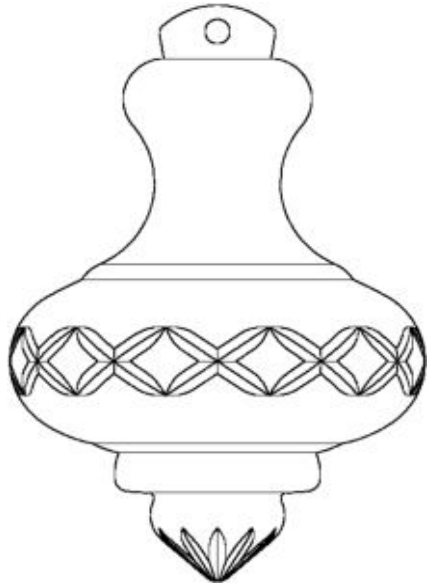

Z.9373 (lead crystal - hand cut)

hanging hole: 5 mm

| | | | |
|------------|---------|---|----|
| 100x65 mm | 11,7406 | 1 | 50 |
| 150x100 mm | 17,4557 | 1 | 18 |
| 200x135 mm | 28,2806 | 1 | 9 |

| | | | |
|------------|--|------------------|---------------|
| | | minimum quantity | |
| EURO piece | | BOX pieces | CARTON pieces |

X-PARTS



Z.9685 (reduction-ring - brass ... for bobeches & centerpieces)

diameter (outside): 33 mm

diameter (middle): 23 mm

diameter (inside): 11 mm

| | | | |
|---------------|--------|-----|-------|
| BRASS | 0,7977 | 200 | 2.400 |
| CHROME PLATED | 0,7977 | 200 | 2.400 |
| GOLD PLATED | 1,0582 | 200 | 2.400 |

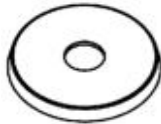

Z.9683 (reduction-ring - plastic ... for bobeches & centerpieces)

diameter (outside): 41 mm

diameter (middle): 38 mm

diameter (inside): 11 mm

| | | | |
|-------------|--------|-----|-------|
| TRANSPARENT | 0,2387 | 200 | 2.400 |
|-------------|--------|-----|-------|



Z.9680 (damping-ring - softplastic ... for bobeches & centerpieces)

diameter (outside): 32 mm

diameter (inside): 23 mm

| | | | |
|-------------|--------|------|--------|
| TRANSPARENT | 0,1669 | 1000 | 12.000 |
|-------------|--------|------|--------|



Z.9688 (bobèche-clip - brass ... for bobeches & centerpieces)

length: 8 mm

depth: 5 mm

width: 3 mm

| | | | |
|---------------|--------|------|---------|
| BRASS | 0,0117 | 7630 | 305.200 |
| CHROME PLATED | 0,0128 | 7630 | 305.200 |
| GOLD PLATED | 0,0432 | 7630 | 305.200 |



Z.9689 (glueing-button - chandelier crystal ... for arms & bobeches)

diameter: 10 mm

height: 7 mm

| | | | |
|---------------|--------|-----|-------|
| CRYSTAL CLEAR | 2,0173 | 100 | 4.000 |
|---------------|--------|-----|-------|

| | minimum quantity | | |
|------------|------------------|---------------|--|
| EURO piece | BOX pieces | CARTON pieces | |



Z.9650 (LED globe-bulb ... solid crystal ... E14 ... 220V ... non-dimmable)

| | | | |
|---------------------------|--------|----|-----|
| 65x40 mm 2.5W 220LM 2700K | 8,3721 | 20 | 240 |
|---------------------------|--------|----|-----|



Z.9658 (LED globe-bulb ... solid crystal ... E27 ... 220V ... non-dimmable)

| | | | |
|-------------------------|---------|---|----|
| 80x50 mm 5W 450LM 2700K | 12,8475 | 6 | 72 |
|-------------------------|---------|---|----|

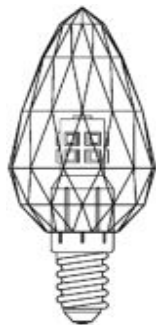

Z.9655 (LED candle-bulb ... solid crystal ... E14 ... 220V ... DIMMABLE)

| | | | |
|-------------------------|--------|----|-----|
| 95x40 mm 4W 450LM 2700K | 8,1657 | 14 | 168 |
|-------------------------|--------|----|-----|

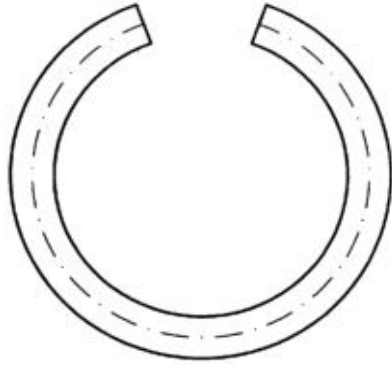

* diameter 70 - 200 mm ... "full ring"



* diameter 250 - 300 mm ... "half ring"



* diameter 350 - 600 mm ... "part ring"



* "straight"

| | |
|-------------------|----------------------|
| CRYSTAL | minimum quantity |
| CLEAR | |
| EURO piece | CARTON pieces |

ARMS-MT

Z.9860 (chandelier crystal - hand made)

(for decorating Metal Arms in "Maria-Theresa-Chandeliers")

diameter: 17x5 mm

inner diameter:

| | | |
|------------------|--------|-----|
| 70 mm | 0,8542 | 200 |
| 80 mm | 0,8542 | 200 |
| 100 mm | 0,9206 | 200 |
| 120 mm | 0,9801 | 200 |
| 150 mm | 1,1749 | 200 |
| 180 mm | 1,2058 | 100 |
| 200 mm | 1,2862 | 100 |
| 250 mm | 1,2862 | 100 |
| 300 mm | 1,2862 | 100 |
| 350 mm | 1,2862 | 100 |
| 400 mm | 1,2862 | 100 |
| 500 mm | 1,2862 | 100 |
| 600 mm | 1,2862 | 100 |
| STRAIGHT / 400mm | 1,2862 | 100 |

CRYSTALminimum
quantity**CLEAR****EURO
piece****BOX
pieces****CARTON
pieces**

ARMS

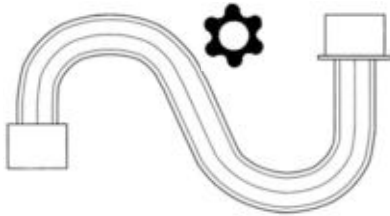
**Z.9862 - fluted (chandelier crystal - machine made)**

| diameter: | caps: | CHROME | GOLD | | |
|------------------------|---------|---------|---------|---|----|
| 150 mm (6") | Ø 22 mm | 15,0391 | 15,0391 | 6 | 72 |
| 200 mm (8") | Ø 22 mm | 16,4063 | 16,4063 | 6 | 72 |
| 250 mm (10") | Ø 22 mm | 17,7734 | 17,7734 | 6 | 72 |
| diameter: 24 mm | | | | | |
| caps: | | | | | |
| 300 mm (12") | Ø 28 mm | 19,9609 | 19,9609 | 6 | 72 |
| 400 mm (16") | Ø 28 mm | 27,3438 | 27,3438 | 6 | 72 |
| diameter: 30 mm | | | | | |
| caps: | | | | | |
| 500 mm (20") | Ø 35 mm | 54,0784 | 54,0784 | 6 | 72 |
| 600 mm (24") | Ø 35 mm | 64,8941 | 64,8941 | 6 | 72 |
| 700 mm (28") | Ø 35 mm | 81,6247 | 81,6247 | 6 | 72 |
| 800 mm (32") | Ø 35 mm | 92,5248 | 92,5248 | 6 | 72 |

**Z.9863 - twisted (chandelier crystal - machine made)**

| diameter: | caps: | CHROME | GOLD | | |
|------------------------|---------|----------|----------|---|----|
| 150 mm (6") | Ø 22 mm | 16,4063 | 16,4063 | 6 | 72 |
| 200 mm (8") | Ø 22 mm | 20,5078 | 20,5078 | 6 | 72 |
| 250 mm (10") | Ø 22 mm | 24,6094 | 24,6094 | 6 | 72 |
| diameter: 24 mm | | | | | |
| caps: | | | | | |
| 300 mm (12") | Ø 28 mm | 28,7109 | 28,7109 | 6 | 72 |
| 400 mm (16") | Ø 28 mm | 38,2813 | 38,2813 | 6 | 72 |
| diameter: 30 mm | | | | | |
| caps: | | | | | |
| 500 mm (20") | Ø 35 mm | 66,7531 | 66,7531 | 6 | 72 |
| 600 mm (24") | Ø 35 mm | 80,1037 | 80,1037 | 6 | 72 |
| 700 mm (28") | Ø 35 mm | 95,3133 | 95,3133 | 6 | 72 |
| 800 mm (32") | Ø 35 mm | 110,2693 | 110,2693 | 6 | 72 |

height x width

CRYSTAL

minimum
quantity

CLEAR

**EURO
piece**

**BOX
pieces**

**CARTON
pieces**

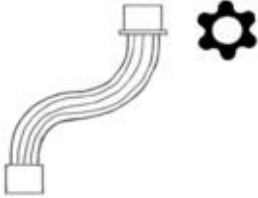

Z.9868 - fluted (chandelier crystal - machine made)

| diameter: 19 mm | caps: | CHROME | GOLD | | |
|-------------------|---------|---------|---------|---|----|
| 200x140 mm (8") | Ø 22 mm | 16,4063 | 16,4063 | 6 | 72 |

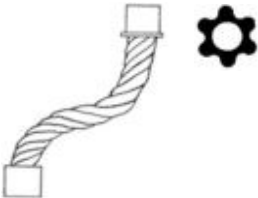

Z.9869 - twisted (chandelier crystal - machine made)

| diameter: 19 mm | caps: | CHROME | GOLD | | |
|-------------------|---------|---------|---------|---|----|
| 200x140 mm (8") | Ø 22 mm | 17,7734 | 17,7734 | 6 | 72 |

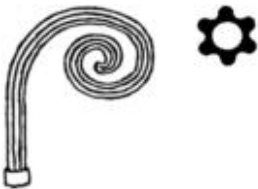

Z.9870 - fluted (chandelier crystal - machine made)

| diameter: 19 mm | cap: | CHROME | GOLD | | |
|-------------------|---------|---------|---------|---|----|
| 150x140 mm (6") | Ø 22 mm | 12,3047 | 12,3047 | 6 | 72 |
| 200x140 mm (8") | Ø 22 mm | 15,0391 | 15,0391 | 6 | 72 |



Z.9871 - twisted (chandelier crystal - machine made)

| diameter: 19 mm | cap: | CHROME | GOLD | | |
|-------------------|---------|---------|---------|---|----|
| 150x140 mm (6") | Ø 22 mm | 13,6719 | 13,6719 | 6 | 72 |
| 200x140 mm (8") | Ø 22 mm | 16,4063 | 16,4063 | 6 | 72 |

| | | | |
|-------------------|-------------------|-------------------|----------------------|
| CRYSTAL | CRYSTAL | minimum quantity | |
| CLEAR | CLEAR | | |
| EURO piece | EURO piece | BOX pieces | CARTON pieces |



Z.9881 - smooth (chandelier crystal - hand made)

| diameter: 19 mm | caps : | CHROME | GOLD | | |
|-----------------|---------|---------|---------|---|----|
| 125 mm (5") | Ø 22 mm | 5,1374 | 5,9401 | 6 | 72 |
| 150 mm (6") | Ø 22 mm | 5,1374 | 5,9401 | 6 | 72 |
| 180 mm (7") | Ø 22 mm | 5,3621 | 6,1970 | 6 | 72 |
| 200 mm (8") | Ø 22 mm | 5,8277 | 6,6625 | 6 | 72 |
| 250 mm (10") | Ø 22 mm | 6,3254 | 7,1442 | 6 | 72 |
| 300 mm (12") | Ø 22 mm | 7,2084 | 8,0914 | 6 | 72 |
| 350 mm (14") | Ø 22 mm | 10,5477 | 11,4788 | 6 | 72 |
| 400 mm (16") | Ø 22 mm | 12,2334 | 13,1806 | 6 | 72 |
| 450 mm (18") | Ø 22 mm | 23,6640 | 24,6594 | 6 | 72 |
| 500 mm (20") | Ø 22 mm | 37,4065 | 38,3858 | 6 | 72 |
| diameter: 25 mm | caps : | CHROME | GOLD | | |
| 300 mm (12") | Ø 30 mm | 20,6940 | 22,3315 | 6 | 72 |
| 350 mm (14") | Ø 30 mm | 26,3611 | 28,0629 | 6 | 72 |
| 400 mm (16") | Ø 30 mm | 33,9227 | 35,6084 | 6 | 72 |
| 450 mm (18") | Ø 30 mm | 37,6794 | 39,3490 | 6 | 72 |
| 500 mm (20") | Ø 30 mm | 44,2135 | 45,8992 | 6 | 72 |
| 550 mm (22") | Ø 30 mm | 47,8418 | 49,5114 | 6 | 72 |
| 600 mm (24") | Ø 30 mm | 52,7062 | 54,3919 | 6 | 72 |
| diameter: 30 mm | caps : | CHROME | GOLD | | |
| 650 mm (26") | Ø 35 mm | 70,2535 | 72,7419 | 6 | 72 |
| 700 mm (28") | Ø 35 mm | 74,1066 | 76,5789 | 6 | 72 |
| 800 mm (32") | Ø 35 mm | 91,6699 | 94,1584 | 6 | 72 |

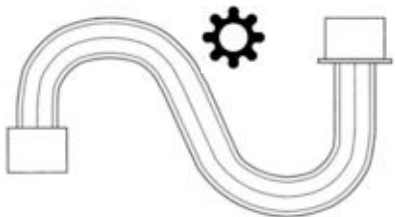

Z.9882 - fluted (chandelier crystal - hand made)

| diameter: 19 mm | caps : | CHROME | GOLD | | |
|-----------------|---------|---------|---------|---|----|
| 125 mm (5") | Ø 22 mm | 5,1374 | 5,9401 | 6 | 72 |
| 150 mm (6") | Ø 22 mm | 5,1374 | 5,9401 | 6 | 72 |
| 180 mm (7") | Ø 22 mm | 5,3621 | 6,1970 | 6 | 72 |
| 200 mm (8") | Ø 22 mm | 5,8277 | 6,6625 | 6 | 72 |
| 250 mm (10") | Ø 22 mm | 6,3254 | 7,1442 | 6 | 72 |
| 300 mm (12") | Ø 22 mm | 7,2084 | 8,0914 | 6 | 72 |
| 350 mm (14") | Ø 22 mm | 10,5477 | 11,4788 | 6 | 72 |
| 400 mm (16") | Ø 22 mm | 12,2334 | 13,1806 | 6 | 72 |
| 450 mm (18") | Ø 22 mm | 23,6640 | 24,6594 | 6 | 72 |
| 500 mm (20") | Ø 22 mm | 37,4065 | 38,3858 | 6 | 72 |
| diameter: 25 mm | caps : | CHROME | GOLD | | |
| 300 mm (12") | Ø 30 mm | 20,6940 | 22,3315 | 6 | 72 |
| 350 mm (14") | Ø 30 mm | 26,3611 | 28,0629 | 6 | 72 |
| 400 mm (16") | Ø 30 mm | 33,9227 | 35,6084 | 6 | 72 |
| 450 mm (18") | Ø 30 mm | 37,6794 | 39,3490 | 6 | 72 |
| 500 mm (20") | Ø 30 mm | 44,2135 | 45,8992 | 6 | 72 |
| 550 mm (22") | Ø 30 mm | 47,8418 | 49,5114 | 6 | 72 |
| 600 mm (24") | Ø 30 mm | 52,7062 | 54,3919 | 6 | 72 |
| diameter: 30 mm | caps : | CHROME | GOLD | | |
| 650 mm (26") | Ø 35 mm | 70,2535 | 72,7419 | 6 | 72 |
| 700 mm (28") | Ø 35 mm | 74,1066 | 76,5789 | 6 | 72 |
| 800 mm (32") | Ø 35 mm | 91,6699 | 94,1584 | 6 | 72 |



Z.9883 - twisted (chandelier crystal - hand made)

| diameter: 19 mm | caps : | CHROME | GOLD | | |
|-----------------|---------|---------|---------|---|----|
| 125 mm (5") | Ø 22 mm | 5,1374 | 5,9401 | 6 | 72 |
| 150 mm (6") | Ø 22 mm | 5,1374 | 5,9401 | 6 | 72 |
| 180 mm (7") | Ø 22 mm | 5,3621 | 6,1970 | 6 | 72 |
| 200 mm (8") | Ø 22 mm | 5,8277 | 6,6625 | 6 | 72 |
| 250 mm (10") | Ø 22 mm | 6,3254 | 7,1442 | 6 | 72 |
| 300 mm (12") | Ø 22 mm | 7,2084 | 8,0914 | 6 | 72 |
| 350 mm (14") | Ø 22 mm | 10,5477 | 11,4788 | 6 | 72 |
| 400 mm (16") | Ø 22 mm | 12,2334 | 13,1806 | 6 | 72 |
| 450 mm (18") | Ø 22 mm | 23,6640 | 24,6594 | 6 | 72 |
| 500 mm (20") | Ø 22 mm | 37,4065 | 38,3858 | 6 | 72 |
| diameter: 25 mm | caps : | CHROME | GOLD | | |
| 300 mm (12") | Ø 30 mm | 20,6940 | 22,3315 | 6 | 72 |
| 350 mm (14") | Ø 30 mm | 26,3611 | 28,0629 | 6 | 72 |
| 400 mm (16") | Ø 30 mm | 33,9227 | 35,6084 | 6 | 72 |
| 450 mm (18") | Ø 30 mm | 37,6794 | 39,3490 | 6 | 72 |
| 500 mm (20") | Ø 30 mm | 44,2135 | 45,8992 | 6 | 72 |
| 550 mm (22") | Ø 30 mm | 47,8418 | 49,5114 | 6 | 72 |
| 600 mm (24") | Ø 30 mm | 52,7062 | 54,3919 | 6 | 72 |
| diameter: 30 mm | caps : | CHROME | GOLD | | |
| 650 mm (26") | Ø 35 mm | 70,2535 | 72,7419 | 6 | 72 |
| 700 mm (28") | Ø 35 mm | 74,1066 | 76,5789 | 6 | 72 |
| 800 mm (32") | Ø 35 mm | 91,6699 | 94,1584 | 6 | 72 |

| height x width | CRYSTAL | CRYSTAL | minimum quantity | CARTON pieces |
|----------------|------------|------------|------------------|---------------|
| | CLEAR | CLEAR | | |
| | EURO piece | EURO piece | BOX pieces | |

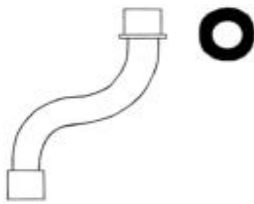

Z.9884 - smooth (chandelier crystal - hand made)

| diameter: 19 mm | caps : | CHROME | GOLD | | |
|------------------|---------|--------|--------|---|----|
| 150x100 mm (6") | Ø 22 mm | 5,8277 | 6,6625 | 6 | 72 |
| 200x150 mm (8") | Ø 22 mm | 6,3254 | 7,1442 | 6 | 72 |
| 250x180 mm (10") | Ø 22 mm | 7,2084 | 8,0914 | 6 | 72 |

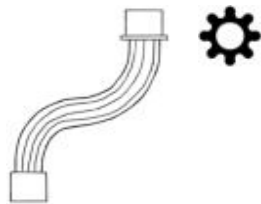

Z.9885 - fluted (chandelier crystal - hand made)

| diameter: 19 mm | caps : | CHROME | GOLD | | |
|------------------|---------|--------|--------|---|----|
| 150x100 mm (6") | Ø 22 mm | 5,8277 | 6,6625 | 6 | 72 |
| 200x150 mm (8") | Ø 22 mm | 6,3254 | 7,1442 | 6 | 72 |
| 250x180 mm (10") | Ø 22 mm | 7,2084 | 8,0914 | 6 | 72 |

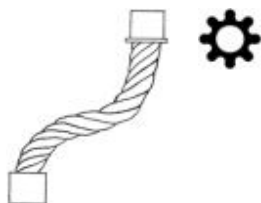

Z.9886 - twisted (chandelier crystal - hand made)

| diameter: 19 mm | caps : | CHROME | GOLD | | |
|------------------|---------|--------|--------|---|----|
| 150x100 mm (6") | Ø 22 mm | 5,8277 | 6,6625 | 6 | 72 |
| 200x150 mm (8") | Ø 22 mm | 6,3254 | 7,1442 | 6 | 72 |
| 250x180 mm (10") | Ø 22 mm | 7,2084 | 8,0914 | 6 | 72 |



Z.9887 - smooth (chandelier crystal - hand made)

| diameter: 19 mm | caps : | CHROME | GOLD | | |
|------------------|---------|--------|--------|---|----|
| 150x150 mm (6") | Ø 22 mm | 6,0364 | 6,5020 | 6 | 72 |
| 200x150 mm (8") | Ø 22 mm | 6,0364 | 6,5020 | 6 | 72 |
| 250x150 mm (10") | Ø 22 mm | 6,0364 | 6,5020 | 6 | 72 |



Z.9888 - fluted (chandelier crystal - hand made)

| diameter: 19 mm | caps : | CHROME | GOLD | | |
|------------------|---------|--------|--------|---|----|
| 150x150 mm (6") | Ø 22 mm | 6,0364 | 6,5020 | 6 | 72 |
| 200x150 mm (8") | Ø 22 mm | 6,0364 | 6,5020 | 6 | 72 |
| 250x150 mm (10") | Ø 22 mm | 6,0364 | 6,5020 | 6 | 72 |



Z.9889 - twisted (chandelier crystal - hand made)

| diameter: 19 mm | caps : | CHROME | GOLD | | |
|------------------|---------|--------|--------|---|----|
| 150x150 mm (6") | Ø 22 mm | 6,0364 | 6,5020 | 6 | 72 |
| 200x150 mm (8") | Ø 22 mm | 6,0364 | 6,5020 | 6 | 72 |
| 250x150 mm (10") | Ø 22 mm | 6,0364 | 6,5020 | 6 | 72 |

COLOR ... BLACK, WHITE, etc. ... +25%
 minimum quantity ... 36 pieces per article/size/color

| | EURO piece | minimum quantity BOX pieces | CARTON pieces |
|--|---------------|--|------------------|
|--|---------------|--|------------------|

RINGS



Z.9670 (brass - machine made)

diameter: 1 mm ... rectangular shape

inner diameter: 30 mm

CHROME PLATED
GOLD PLATED

| | | |
|--------|-----|-------|
| 0,5305 | 200 | 2.400 |
| 0,8620 | 200 | 2.400 |

inner diameter: 35 mm

CHROME PLATED
GOLD PLATED

| | | |
|--------|-----|-------|
| 0,5971 | 200 | 2.400 |
| 0,9285 | 200 | 2.400 |



Z.9672 (plastic - machine made)

diameter: 5 mm ... round shape

inner diameter: 38 mm

TRANSPARENT

| | | |
|--------|-----|-------|
| 0,3306 | 200 | 2.400 |
|--------|-----|-------|



Z.9674 (chandelier crystal - hand made)

diameter: 5 mm ... round shape

inner diameter: 32 mm

CRYSTAL CLEAR

| | | |
|--------|----|-----|
| 0,5407 | 80 | 960 |
|--------|----|-----|



Z.9675 (chandelier crystal - hand made)

diameter: 5 mm ... triangular shape

inner diameter: 30 mm

CRYSTAL CLEAR

wire:

CHROME

| | | |
|--------|-----|-------|
| 2,4609 | 200 | 2.400 |
|--------|-----|-------|

inner diameter: 35 mm

CRYSTAL CLEAR

wire:

CHROME

| | | |
|--------|-----|-------|
| 3,0078 | 150 | 1.800 |
|--------|-----|-------|

inner diameter: 45 mm

CRYSTAL CLEAR

wire:

CHROME

| | | |
|--------|-----|-------|
| 3,2813 | 100 | 1.200 |
|--------|-----|-------|

| | EURO piece | minimum quantity BOX pieces | CARTON pieces |
|--|---------------|--------------------------------------|------------------|
|--|---------------|--------------------------------------|------------------|



Z.9676 (optic crystal - machine cut)

diameter: 9 mm ... faceted shape (full-cut)

inner diameter: 32 mm

CRYSTAL CLEAR

| 2,9331|

72

864

inner diameter: 44 mm

CRYSTAL CLEAR

| 2,9783|

60

720



Z.9677 (chandelier crystal - machine cut)

diameter: 6 mm ... faceted shape (full-cut) ... 20 pieces 6mm-beads

inner diameter: 30 mm

CRYSTAL CLEAR

| 4,6288|

100

1.200

diameter: 8 mm ... faceted shape (full-cut) ... 18 pieces 8mm-beads

inner diameter: 35 mm

CRYSTAL CLEAR

| 4,9166|

80

960

diameter: 10 mm ... faceted shape (full-cut) ... 16 pieces 10mm-beads

inner diameter: 40 mm

CRYSTAL CLEAR

| 4,9315|

60

720

diameter: 12 mm ... faceted shape (full-cut) ... 15 pieces 12mm-beads

inner diameter: 45 mm

CRYSTAL CLEAR

| 5,9752|

40

480

| | | | |
|------------|------------|------------------|---------------|
| | | minimum quantity | |
| EURO piece | EURO piece | BOX pieces | CARTON pieces |

SLEEVES



Z.9660 (white chandelier crystal - machine made)

| | Ø | Ø | | |
|----------------------------|------------|--------|----|-----|
| <u>diameter (outside):</u> | 28 mm | 32 mm | | |
| <u>diameter (inside):</u> | 25 mm | 29 mm | | |
| 50 mm | 0,9842 | 0,9842 | 40 | 480 |
| 55 mm | 0,9842 | 0,9842 | 40 | 480 |
| 60 mm | 0,9842 | 0,9842 | 40 | 480 |
| 65 mm | 1,0034 | 1,0034 | 40 | 480 |
| 70 mm | 1,0034 | 1,0034 | 36 | 432 |
| 75 mm | 1,2585 | 1,2585 | 36 | 432 |
| 80 mm | 1,3258 | 1,3258 | 32 | 384 |
| 85 mm | 1,3932 | 1,3932 | 32 | 384 |
| 90 mm | 1,4077 | 1,4077 | 26 | 312 |
| 95 mm | 1,4221 | 1,4221 | 26 | 312 |
| 100 mm | 1,4558 | 1,4558 | 26 | 312 |
| 110 mm | 1,5352 | 1,5352 | 20 | 240 |
| 120 mm | 1,6146 | 1,6146 | 20 | 240 |
| 130 mm | 1,7830 | 1,7830 | 20 | 240 |
| 140 mm | 1,9755 | 1,9755 | 16 | 192 |
| 150 mm | 2,1584 | 2,1584 | 16 | 192 |
| 160 mm | 2,2883 | 2,2883 | 16 | 192 |
| 170 mm | 2,4833 | 2,4833 | 10 | 120 |
| 180 mm | 2,6252 | 2,6252 | 10 | 120 |
| 190 mm | 2,8875 | 2,8875 | 8 | 96 |
| 200 mm | 3,0319 | 3,0319 | 8 | 96 |
| 210 mm | 3,1835 | 3,1835 | 8 | 96 |
| 220 mm | 3,3423 | 3,3423 | 8 | 96 |
| 230 mm | 3,5107 | 3,5107 | 8 | 96 |
| 240 mm | 3,6864 | 3,6864 | 8 | 96 |
| 250 mm ... maximum length | 3,8717 | 3,8717 | 8 | 96 |
| + bespoke lengths | on request | | | |



Z.9663 (brass - machine made)

| | | | | |
|----------------------------------|------------|--|----|-----|
| <u>diameter (outside): 26 mm</u> | | | | |
| <u>diameter (inside): 24 mm</u> | | | | |
| 100 mm BRASS | 6,5375 | | 26 | 312 |
| 100 mm CHROME PLATED | 7,5544 | | 26 | 312 |
| 100 mm GOLD PLATED | 8,7166 | | 26 | 312 |
| + bespoke lengths | on request | | | |

| | EURO piece | minimum quantity | BOX pieces | CARTON pieces |
|--|---------------|---------------------|---------------|------------------|
|--|---------------|---------------------|---------------|------------------|



Z.9666 (plastic - machine made)

diameter (outside): 26 mm

diameter (inside): 24 mm

(for self-cutting)

| | | | | |
|---------|-------|---------|----|-----|
| 1200 mm | WHITE | 12,1472 | 10 | 600 |
|---------|-------|---------|----|-----|



Z.9667 (plastic - machine made)

diameter (outside): 26 mm

diameter (inside): 24 mm

| | | | | |
|--------|-------|--------|----|-----|
| 65 mm | WHITE | 0,2075 | 50 | 600 |
| 65 mm | IVORY | 0,2075 | 50 | 600 |
| 65 mm | BROWN | 0,2075 | 50 | 600 |
| 85 mm | WHITE | 0,3459 | 40 | 480 |
| 85 mm | IVORY | 0,3459 | 40 | 480 |
| 85 mm | BROWN | 0,3459 | 40 | 480 |
| 100 mm | WHITE | 0,4372 | 32 | 384 |
| 100 mm | IVORY | 0,4372 | 32 | 384 |
| 100 mm | BROWN | 0,4372 | 32 | 384 |

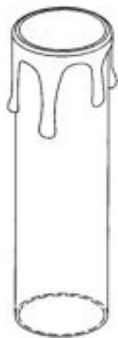

Z.9668 (plastic - machine made)

diameter (outside): 26 mm

diameter (inside): 24 mm

| | | | | |
|--------|---------------|--------|----|-----|
| 65 mm | WHITE | 0,2601 | 40 | 480 |
| 65 mm | IVORY | 0,2601 | 40 | 480 |
| 65 mm | BROWN | 0,2601 | 40 | 480 |
| 65 mm | BROWN-antique | 0,3902 | 40 | 480 |
| 85 mm | WHITE | 0,4261 | 32 | 384 |
| 85 mm | IVORY | 0,4261 | 32 | 384 |
| 85 mm | BROWN | 0,4261 | 32 | 384 |
| 85 mm | BROWN-antique | 0,6392 | 32 | 384 |
| 100 mm | WHITE | 0,5064 | 26 | 312 |
| 100 mm | IVORY | 0,5064 | 26 | 312 |
| 100 mm | BROWN | 0,5064 | 26 | 312 |
| 100 mm | BROWN-antique | 0,7596 | 26 | 312 |

| CRYSTAL | CRYSTAL <u>coated</u> | COLOR | COLOR <u>coated</u> | minimum quantity | |
|---------------|--|---|--|---------------------|------------------|
| CLEAR | AB AFLAME AMBER ANTIQUÉ GOLD SILVER | ALEXANDRITE AMETHYST AQUAMARINE EMERALD JET ROSA LIN RUBY SAPPHIRE SMOKE TOPAZ | AB AFLAME AMBER ANTIQUÉ GOLD SILVER | | |
| | BB BW OG OS VL VM | | BB BW OG OS VL VM | | |
| EURO piece | EURO piece | EURO piece | EURO piece | BOX pieces | CARTON pieces |

BEADS

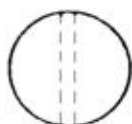

Z.9298 (chandelier crystal - machine made)

| | | | | | |
|-------|--------|--------|--|--------|---------|
| 4 mm | 0,0096 | 0,1426 | | 16.000 | 192.000 |
| 6 mm | 0,0134 | 0,1464 | | 12.000 | 144.000 |
| 8 mm | 0,0234 | 0,1563 | | 6.000 | 72.000 |
| 10 mm | 0,0409 | 0,1739 | | 3.000 | 36.000 |
| 12 mm | 0,0607 | 0,1937 | | 2.000 | 24.000 |
| 14 mm | 0,1110 | 0,2439 | | 1.200 | 14.400 |
| 16 mm | 0,1758 | 0,3749 | | 400 | 4.800 |
| 18 mm | 0,2482 | 0,4473 | | 320 | 3.840 |
| 20 mm | 0,3971 | 0,6471 | | 320 | 3.840 |
| 25 mm | 0,7095 | 1,0706 | | 150 | 1.800 |
| 30 mm | 1,6384 | 2,3174 | | 48 | 576 |
| 40 mm | 2,1900 | 3,0182 | | 40 | 480 |



Z.9281 (chandelier crystal - machine made)

| | | | | | |
|---------------|--------|--------|--|-------|--------|
| 2,0 mm | 0,0017 | 0,1538 | | 2.125 | 25.500 |
| 2,0 mm CHROME | 0,0020 | | | 2.125 | 25.500 |
| 2,0 mm GOLD | 0,0020 | | | 2.125 | 25.500 |
| 2,3 mm | 0,0021 | 0,1542 | | 1.700 | 20.400 |
| 2,3 mm CHROME | 0,0024 | | | 1.700 | 20.400 |
| 2,3 mm GOLD | 0,0024 | | | 1.700 | 20.400 |
| 2,6 mm | 0,0032 | 0,1553 | | 1.133 | 13.596 |
| 2,6 mm CHROME | 0,0037 | | | 1.133 | 13.596 |
| 2,6 mm GOLD | 0,0037 | | | 1.133 | 13.596 |
| 3,1 mm | 0,0051 | 0,1572 | | 708 | 8.496 |
| 3,1 mm CHROME | 0,0059 | | | 708 | 8.496 |
| 3,1 mm GOLD | 0,0059 | | | 708 | 8.496 |
| 3,5 mm | 0,0091 | 0,1612 | | 395 | 4.740 |
| 3,5 mm CHROME | 0,0105 | | | 395 | 4.740 |
| 3,5 mm GOLD | 0,0105 | | | 395 | 4.740 |
| 4,0 mm | 0,0134 | 0,1655 | | 270 | 3.240 |
| 4,0 mm CHROME | 0,0154 | | | 270 | 3.240 |
| 4,0 mm GOLD | 0,0154 | | | 270 | 3.240 |



Z.9299 (chandelier crystal - machine made)

| | | | | | |
|---------|--------|--------|--|-----|-------|
| 9x20 mm | 0,2658 | 0,5158 | | 320 | 3.840 |
|---------|--------|--------|--|-----|-------|



Z.9271 (chandelier crystal - machine made)

| | | | | | |
|----------|--------|--------|--|-------|--------|
| 16x9 mm | 0,0897 | 0,2888 | | 2.000 | 24.000 |
| 18x11 mm | 0,1460 | 0,3451 | | 1.500 | 18.000 |
| 20x13 mm | 0,1928 | 0,4427 | | 900 | 10.800 |
| 24x15 mm | 0,5611 | 0,8111 | | 120 | 1.440 |

| CRYSTAL | CRYSTAL <u>coated</u> | COLOR | COLOR <u>coated</u> | minimum quantity | |
|---------------|--|---|--|---------------------|------------------|
| CLEAR | AB AFLAME AMBER ANTIQUÉ GOLD SILVER | ALEXANDRITE AMETHYST AQUAMARINE EMERALD JET ROSA LIN RUBY SAPPHIRE SMOKE TOPAZ | AB AFLAME AMBER ANTIQUÉ GOLD SILVER | | |
| | BB BW OG OS VL VM | | BB BW OG OS VL VM | | |
| EURO piece | EURO piece | EURO piece | EURO piece | BOX pieces | CARTON pieces |



Z.9295 (chandelier crystal - machine cut)

| | | | | | | |
|-------|--------|--------|--------|--------|--------|---------|
| 4 mm | 0,0257 | 0,1587 | | | 16.000 | 192.000 |
| 6 mm | 0,0549 | 0,1879 | | | 12.000 | 144.000 |
| 8 mm | 0,0739 | 0,2069 | 0,1118 | 0,2448 | 6.000 | 72.000 |
| 10 mm | 0,0838 | 0,2168 | | | 3.000 | 36.000 |
| 12 mm | 0,1451 | 0,2781 | | | 2.000 | 24.000 |
| 14 mm | 0,2278 | 0,3607 | | | 1.200 | 14.400 |
| 16 mm | 0,3533 | 0,5524 | | | 400 | 4.800 |
| 18 mm | 0,4409 | 0,6400 | | | 320 | 3.840 |
| 20 mm | 0,5285 | 0,7784 | | | 320 | 3.840 |
| 25 mm | 1,3140 | 1,6751 | | | 150 | 1.800 |
| 30 mm | 2,1730 | 2,8520 | | | 48 | 576 |
| 40 mm | 3,0405 | 3,8688 | | | 40 | 480 |



6-30mm
4 rows of facets

32-40mm
5 rows of facets

Z.9294 (chandelier crystal - machine cut) *

| | | | | | | |
|--------------|--------|--------|---------|---------|-------|--------|
| 6 mm | 0,0254 | 0,1584 | 0,0564 | 0,1894 | 1.680 | 20.160 |
| 8 mm | 0,0339 | 0,1669 | 0,0754 | 0,2084 | 1.540 | 18.480 |
| 10 mm | 0,0511 | 0,1841 | 0,1136 | 0,2466 | 1.260 | 15.120 |
| 12 mm | 0,0941 | 0,2271 | 0,2092 | 0,3422 | 1.120 | 13.440 |
| 14 mm | 0,1778 | 0,3108 | 0,3952 | 0,5282 | 980 | 11.760 |
| 16 mm | 0,2991 | 0,4982 | 0,7385 | 0,9376 | 300 | 3.600 |
| 18 mm | 0,4828 | 0,6819 | 1,2621 | 1,4612 | 300 | 3.600 |
| 20 mm | 0,6251 | 0,8750 | 1,5434 | 1,7933 | 120 | 1.440 |
| 22 mm | 0,8211 | 1,0919 | 1,8246 | 2,0955 | 120 | 1.440 |
| 24 mm | 1,2025 | 1,5052 | 2,8130 | 3,1157 | 120 | 1.440 |
| 26 mm | 1,3684 | 1,7500 | 3,0409 | 3,4225 | 72 | 864 |
| 28 mm | 1,5738 | 2,0181 | 3,4973 | 4,0218 | 72 | 864 |
| <u>30 mm</u> | 1,7105 | 2,3895 | 3,8011 | 4,4801 | 72 | 864 |
| 32 mm | 3,0897 | 3,7491 | 6,1795 | 6,8388 | 40 | 480 |
| 34 mm | 3,7680 | 4,5459 | 7,5359 | 8,2455 | 40 | 480 |
| 36 mm | 4,5216 | 5,2748 | 9,0431 | 9,7964 | 34 | 408 |
| 38 mm | 5,8780 | 6,6822 | 11,7561 | 12,5602 | 34 | 408 |
| 40 mm | 7,6414 | 8,4696 | 15,2829 | 16,1110 | 34 | 408 |

* minimum-quantity COLOR ... 6 boxes ... per size & per COLOR

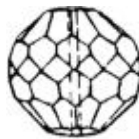

Z.9291 (chandelier crystal - machine cut) *

| | | | | | | |
|-------|--------|--------|--------|--------|--------|---------|
| 4 mm | 0,0136 | 0,1656 | 0,0271 | 0,1791 | 14.400 | 172.800 |
| 5 mm | 0,0167 | 0,1687 | 0,0334 | 0,1854 | 14.400 | 172.800 |
| 6 mm | 0,0202 | 0,1722 | 0,0404 | 0,1924 | 12.000 | 144.000 |
| 7 mm | 0,0255 | 0,1775 | 0,0510 | 0,2030 | 9.000 | 108.000 |
| 8 mm | 0,0358 | 0,1878 | 0,0717 | 0,2236 | 6.000 | 72.000 |
| 9 mm | 0,0656 | 0,2176 | 0,1312 | 0,2832 | 4.000 | 48.000 |
| 10 mm | 0,0735 | 0,2255 | 0,1471 | 0,2991 | 3.000 | 36.000 |
| 12 mm | 0,1237 | 0,2757 | 0,2474 | 0,3994 | 2.000 | 24.000 |
| 14 mm | 0,2209 | 0,3728 | 0,4417 | 0,5937 | 1.200 | 14.400 |
| 16 mm | 0,3757 | 0,6033 | 0,7514 | 0,9789 | 400 | 4.800 |
| 18 mm | 0,5622 | 0,7898 | 1,1244 | 1,3519 | 320 | 3.840 |
| 20 mm | 0,8657 | 1,1513 | 1,7313 | 2,0170 | 320 | 3.840 |

* minimum-quantity COLOR ... 6 boxes ... per size & per COLOR



Z.9290 (chandelier crystal - machine cut)

| | | | | | | |
|-------|--------|--------|--|--|-----|-------|
| 20 mm | 1,0307 | 1,4381 | | | 144 | 1.728 |
| 25 mm | 1,5668 | 1,9279 | | | 48 | 576 |
| 30 mm | 2,1754 | 2,8543 | | | 48 | 576 |
| 40 mm | 4,0733 | 4,9016 | | | 40 | 480 |
| 50 mm | 5,2742 | 6,9690 | | | 12 | 144 |

| CRYSTAL | CRYSTAL <u>coated</u> | COLOR | COLOR <u>coated</u> | minimum quantity | |
|---------------|--|---|--|---------------------|------------------|
| CLEAR | AB AFLAME AMBER ANTIQUÉ GOLD SILVER | ALEXANDRITE AMETHYST AQUAMARINE EMERALD JET ROSA LIN RUBY SAPPHIRE SMOKE TOPAZ | AB AFLAME AMBER ANTIQUÉ GOLD SILVER | | |
| | BB BW OG OS VL VM | | BB BW OG OS VL VM | | |
| EURO piece | EURO piece | EURO piece | EURO piece | BOX pieces | CARTON pieces |



Z.9240 (chandelier crystal - machine cut)

| | | | | | |
|-------|--------|--------|--|--------|---------|
| 4 mm | 0,0204 | 0,1534 | | 16.000 | 192.000 |
| 6 mm | 0,0409 | 0,1739 | | 12.000 | 144.000 |
| 8 mm | 0,0555 | 0,1885 | | 6.000 | 72.000 |
| 10 mm | 0,1387 | 0,2717 | | 3.000 | 36.000 |
| 12 mm | 0,2190 | 0,3520 | | 2.000 | 24.000 |
| 14 mm | 0,3376 | 0,4706 | | 1.200 | 14.400 |



Z.9242 (chandelier crystal - machine cut)

| | | | | | |
|----------|--------|--------|--|-----|-------|
| 30x12 mm | 0,3971 | 0,9513 | | 180 | 2.160 |
|----------|--------|--------|--|-----|-------|



Z.9250 (chandelier crystal - machine cut)

| | | | | | |
|---------|--------|--------|--|-------|--------|
| 7x14 mm | 0,0725 | 0,2450 | | 1.800 | 21.600 |
|---------|--------|--------|--|-------|--------|

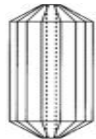

Z.9251 (chandelier crystal - machine cut)

| | | | | | |
|-----------|---------|---------|--|----|-------|
| 32x22 mm | 1,7794 | 2,3217 | | 96 | 1.152 |
| 50x22 mm | 2,7118 | 3,4960 | | 48 | 576 |
| 63x22 mm | 3,3133 | 4,3395 | | 48 | 576 |
| 76x22 mm | 4,2856 | 5,5227 | | 20 | 240 |
| 89x22 mm | 5,1876 | 6,6572 | | 20 | 240 |
| 100x22 mm | 5,5097 | 7,1600 | | 15 | 180 |
| 125x22 mm | 6,6449 | 8,7556 | | 15 | 180 |
| 150x22 mm | 8,3934 | 10,9303 | | 10 | 120 |
| 175x22 mm | 10,7250 | 13,7460 | | 10 | 120 |
| 200x22 mm | 13,3150 | 17,1108 | | 10 | 120 |

| CRYSTAL | CRYSTAL <u>coated</u> | COLOR | COLOR <u>coated</u> | minimum quantity | |
|---------------|--|---|--|---------------------|------------------|
| CLEAR | AB AFLAME AMBER ANTIQUÉ GOLD SILVER | ALEXANDRITE AMETHYST AQUAMARINE EMERALD JET ROSA LIN RUBY SAPPHIRE SMOKE TOPAZ | AB AFLAME AMBER ANTIQUÉ GOLD SILVER | | |
| | BB BW OG OS VL VM | | BB BW OG OS VL VM | | |
| EURO piece | EURO piece | EURO piece | EURO piece | BOX pieces | CARTON pieces |



Z.9260 (chandelier crystal - machine cut)

| | | | | | |
|-------|--------|--------|--|--------|---------|
| 4 mm | 0,0117 | 0,1447 | | 16.000 | 192.000 |
| 6 mm | 0,0204 | 0,1534 | | 12.000 | 144.000 |
| 8 mm | 0,0263 | 0,1593 | | 6.000 | 72.000 |
| 10 mm | 0,0380 | 0,1709 | | 3.000 | 36.000 |
| 12 mm | 0,0672 | 0,2001 | | 2.000 | 24.000 |
| 14 mm | 0,1489 | 0,3480 | | 1.200 | 14.400 |



Z.9261 (chandelier crystal - machine cut)

| | | | | | |
|----------|--------|--------|--|-------|--------|
| 16x9 mm | 0,4871 | 0,6863 | | 2.000 | 24.000 |
| 18x11 mm | 0,5673 | 0,7665 | | 1.500 | 18.000 |
| 20x13 mm | 0,7209 | 0,9709 | | 900 | 10.800 |



Z.9297 (chandelier crystal - machine pressed ... antique appearance)

| | | | | | |
|-------|--------|--------|--|--------|---------|
| 4 mm | 0,0070 | 0,1400 | | 16.000 | 192.000 |
| 5 mm | 0,0103 | 0,1433 | | 14.000 | 168.000 |
| 6 mm | 0,0152 | 0,1482 | | 12.000 | 144.000 |
| 7 mm | 0,0222 | 0,1552 | | 4.000 | 48.000 |
| 8 mm | 0,0331 | 0,1661 | | 2.000 | 24.000 |
| 9 mm | 0,0477 | 0,1807 | | 2.000 | 24.000 |
| 10 mm | 0,0651 | 0,1981 | | 1.500 | 18.000 |
| 12 mm | 0,1244 | 0,2574 | | 1.500 | 18.000 |
| 14 mm | 0,1873 | 0,3203 | | 1.200 | 14.400 |
| 16 mm | 0,3184 | 0,5176 | | 400 | 4.800 |
| 18 mm | 0,4849 | 0,6840 | | 320 | 3.840 |
| 20 mm | 0,9974 | 1,2831 | | 320 | 3.840 |

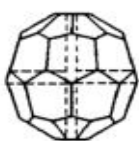

Z.9244 (chandelier crystal - machine cut ... crisscross hole)

| | | | | | |
|-------|--------|--------|--|-------|--------|
| 10 mm | 0,2424 | 0,3753 | | 3.000 | 36.000 |
| 20 mm | 0,7679 | 1,0179 | | 320 | 3.840 |

EURO
pieceEURO
pieceEURO
pieceEURO
pieceEURO
piece

DROPS & FRUITS & LEAVES



Z.9402 (chandelier crystal)

40 mm

| | |
|----------------------|--------|
| BOX pieces | 20 |
| CARTON pieces | 240 |
| CRYSTAL CLEAR | 3,4824 |
| CRYSTAL AB | 4,4291 |
| CRYSTAL AFLAME | 4,4291 |
| CRYSTAL AMBER | 4,4291 |
| CRYSTAL ANTIQUE | 4,4291 |
| CRYSTAL GOLD | 4,4291 |
| CRYSTAL SILVER | 4,4291 |
| ALEXANDRITE | 6,9648 |
| AMETHYST | 6,9648 |
| AQUAMARINE | 6,9648 |
| EMERALD | 6,9648 |
| JET | 6,9648 |
| ROSALIN | 6,9648 |
| RUBY | 6,9648 |
| SAPPHIRE | 6,9648 |
| SMOKE | 6,9648 |
| TOPAZ | 6,9648 |



Z.9403 (chandelier crystal)

20 mm
25 mm
30 mm
35 mm
40 mm

| | | | | | |
|----------------------|--------|--------|--------|--------|--------|
| BOX pieces | 50 | 50 | 50 | 20 | 20 |
| CARTON pieces | 600 | 600 | 600 | 240 | 240 |
| CRYSTAL CLEAR | 1,4198 | 1,7747 | 2,2874 | 3,0762 | 4,1805 |
| CRYSTAL AB | 1,8857 | 2,3957 | 3,0634 | 3,9373 | 5,1272 |
| CRYSTAL AFLAME | 1,8857 | 2,3957 | 3,0634 | 3,9373 | 5,1272 |
| CRYSTAL AMBER | 1,8857 | 2,3957 | 3,0634 | 3,9373 | 5,1272 |
| CRYSTAL ANTIQUE | 1,8857 | 2,3957 | 3,0634 | 3,9373 | 5,1272 |
| CRYSTAL GOLD | 1,8857 | 2,3957 | 3,0634 | 3,9373 | 5,1272 |
| CRYSTAL SILVER | 1,8857 | 2,3957 | 3,0634 | 3,9373 | 5,1272 |
| ALEXANDRITE | 2,8396 | 2,5635 | 3,3128 | 4,4565 | 5,9946 |
| AMETHYST | 2,8396 | 2,5635 | 3,3128 | 4,4565 | 5,9946 |
| AQUAMARINE | 2,8396 | 2,5635 | 3,3128 | 4,4565 | 5,9946 |
| EMERALD | 2,8396 | 2,5635 | 3,3128 | 4,4565 | 5,9946 |
| JET | 2,8396 | 2,5635 | 3,3128 | 4,4565 | 5,9946 |
| ROSALIN | 2,8396 | 2,5635 | 3,3128 | 4,4565 | 5,9946 |
| RUBY | 2,8396 | 2,5635 | 3,3128 | 4,4565 | 5,9946 |
| SAPPHIRE | 2,8396 | 2,5635 | 3,3128 | 4,4565 | 5,9946 |
| SMOKE | 2,8396 | 2,5635 | 3,3128 | 4,4565 | 5,9946 |
| TOPAZ | 2,8396 | 2,5635 | 3,3128 | 4,4565 | 5,9946 |

50 mm
60 mm

| | | |
|----------------------|---------|---------|
| BOX pieces | 10 | 10 |
| CARTON pieces | 120 | 120 |
| CRYSTAL CLEAR | 8,2820 | 10,6483 |
| CRYSTAL AB | 9,7885 | 12,8577 |
| CRYSTAL AFLAME | 9,7885 | 12,8577 |
| CRYSTAL AMBER | 9,7885 | 12,8577 |
| CRYSTAL ANTIQUE | 9,7885 | 12,8577 |
| CRYSTAL GOLD | 9,7885 | 12,8577 |
| CRYSTAL SILVER | 9,7885 | 12,8577 |
| ALEXANDRITE | 11,1610 | 14,3161 |
| AMETHYST | 11,1610 | 14,3161 |
| AQUAMARINE | 11,1610 | 14,3161 |
| EMERALD | 11,1610 | 14,3161 |
| JET | 11,1610 | 14,3161 |
| ROSALIN | 11,1610 | 14,3161 |
| RUBY | 11,1610 | 14,3161 |
| SAPPHIRE | 11,1610 | 14,3161 |
| SMOKE | 11,1610 | 14,3161 |
| TOPAZ | 11,1610 | 14,3161 |

EURO
pieceEURO
pieceEURO
pieceEURO
piece**Z.9400 (chandelier cryst.)****14x9 mm****20x14 mm****25x16 mm****29x18 mm**

| | | | | |
|----------------------|--------|-------|-------|-------|
| BOX pieces | 3.000 | 600 | 500 | 400 |
| CARTON pieces | 36.000 | 7.200 | 6.000 | 4.800 |

| | | | | |
|-----------------|--------|--------|--------|--------|
| CRYSTAL CLEAR | 0,0895 | 0,2195 | 0,3544 | 0,4709 |
| CRYSTAL AB | 0,2073 | 0,4409 | 0,6308 | 0,9517 |
| CRYSTAL AFLAME | 0,2073 | 0,4409 | 0,6308 | 0,9517 |
| CRYSTAL AMBER | 0,2073 | 0,4409 | 0,6308 | 0,9517 |
| CRYSTAL ANTIQUE | 0,2073 | 0,4409 | 0,6308 | 0,9517 |
| CRYSTAL GOLD | 0,2073 | 0,4409 | 0,6308 | 0,9517 |
| CRYSTAL SILVER | 0,2073 | 0,4409 | 0,6308 | 0,9517 |
| ALEXANDRITE | 0,1337 | 0,3322 | 0,5162 | 0,6317 |
| AMETHYST | 0,1337 | 0,3322 | 0,5162 | 0,6317 |
| AQUAMARINE | 0,1337 | 0,3322 | 0,5162 | 0,6317 |
| EMERALD | 0,1337 | 0,3322 | 0,5162 | 0,6317 |
| JET | 0,1337 | 0,3322 | 0,5162 | 0,6317 |
| ROSA LIN | 0,1337 | 0,3322 | 0,5162 | 0,6317 |
| RUBY | 0,1337 | 0,3322 | 0,5162 | 0,6317 |
| SAPPHIRE | 0,1337 | 0,3322 | 0,5162 | 0,6317 |
| SMOKE | 0,1337 | 0,3322 | 0,5162 | 0,6317 |
| TOPAZ | 0,1337 | 0,3322 | 0,5162 | 0,6317 |

**Z.9405 (chandelier cryst.)****50x25 mm****75x38 mm****100x50 mm**

| | | | |
|----------------------|-----|-----|----|
| BOX pieces | 54 | 16 | 5 |
| CARTON pieces | 648 | 192 | 60 |

| | | | |
|-----------------|--------|--------|---------|
| CRYSTAL CLEAR | 2,6148 | 5,7063 | 8,1633 |
| CRYSTAL AB | 3,5143 | 8,1769 | 14,4761 |
| CRYSTAL AFLAME | 3,5143 | 8,1769 | 14,4761 |
| CRYSTAL AMBER | 3,5143 | 8,1769 | 14,4761 |
| CRYSTAL ANTIQUE | 3,5143 | 8,1769 | 14,4761 |
| CRYSTAL GOLD | 3,5143 | 8,1769 | 14,4761 |
| CRYSTAL SILVER | 3,5143 | 8,1769 | 14,4761 |
| ALEXANDRITE | 4,9298 | 8,9671 | 14,0735 |
| AMETHYST | 4,9298 | 8,9671 | 14,0735 |
| AQUAMARINE | 4,9298 | 8,9671 | 14,0735 |
| EMERALD | 4,9298 | 8,9671 | 14,0735 |
| JET | 4,9298 | 8,9671 | 14,0735 |
| ROSA LIN | 4,9298 | 8,9671 | 14,0735 |
| RUBY | 4,9298 | 8,9671 | 14,0735 |
| SAPPHIRE | 4,9298 | 8,9671 | 14,0735 |
| SMOKE | 4,9298 | 8,9671 | 14,0735 |
| TOPAZ | 4,9298 | 8,9671 | 14,0735 |

**Z.9406 (chandelier cryst.)****35x30 mm****45x40 mm**

| | | |
|----------------------|-----|-----|
| BOX pieces | 40 | 20 |
| CARTON pieces | 480 | 240 |

| | | |
|-----------------|--------|--------|
| CRYSTAL CLEAR | 2,9973 | 3,8255 |
| CRYSTAL AB | 3,7733 | 4,7720 |
| CRYSTAL AFLAME | 3,7733 | 4,7720 |
| CRYSTAL AMBER | 3,7733 | 4,7720 |
| CRYSTAL ANTIQUE | 3,7733 | 4,7720 |
| CRYSTAL GOLD | 3,7733 | 4,7720 |
| CRYSTAL SILVER | 3,7733 | 4,7720 |

| EURO piece | EURO piece | EURO piece | EURO piece | EURO piece |
|---------------|---------------|---------------|---------------|---------------|
|---------------|---------------|---------------|---------------|---------------|



| Z.9420 (chandelier crystal) | 50x20 mm | 75x24 mm | 100x28 mm | 125x30 mm | 150x32 mm |
|------------------------------------|-----------------|-----------------|------------------|------------------|------------------|
| BOX pieces | 108 | 72 | 30 | 24 | 12 |
| CARTON pieces | 1.296 | 864 | 360 | 288 | 144 |
| CRYSTAL CLEAR | 1,0216 | 1,4304 | 1,9413 | 2,4520 | 3,0650 |
| CRYSTAL AB | 1,4766 | 2,0663 | 2,7612 | 3,4970 | 4,2763 |
| CRYSTAL AFLAME | 1,4766 | 2,0663 | 2,7612 | 3,4970 | 4,2763 |
| CRYSTAL AMBER | 1,4766 | 2,0663 | 2,7612 | 3,4970 | 4,2763 |
| CRYSTAL ANTIQUE | 1,4766 | 2,0663 | 2,7612 | 3,4970 | 4,2763 |
| CRYSTAL GOLD | 1,4766 | 2,0663 | 2,7612 | 3,4970 | 4,2763 |
| CRYSTAL SILVER | 1,4766 | 2,0663 | 2,7612 | 3,4970 | 4,2763 |
| ALEXANDRITE | 2,2476 | 3,1468 | 4,2707 | 5,3945 | 6,7430 |
| AMETHYST | 2,2476 | 3,1468 | 4,2707 | 5,3945 | 6,7430 |
| AQUAMARINE | 2,2476 | 3,1468 | 4,2707 | 5,3945 | 6,7430 |
| EMERALD | 2,2476 | 3,1468 | 4,2707 | 5,3945 | 6,7430 |
| JET | 2,2476 | 3,1468 | 4,2707 | 5,3945 | 6,7430 |
| ROSALIN | 2,2476 | 3,1468 | 4,2707 | 5,3945 | 6,7430 |
| RUBY | 2,2476 | 3,1468 | 4,2707 | 5,3945 | 6,7430 |
| SAPPHIRE | 2,2476 | 3,1468 | 4,2707 | 5,3945 | 6,7430 |
| SMOKE | 2,2476 | 3,1468 | 4,2707 | 5,3945 | 6,7430 |
| TOPAZ | 2,2476 | 3,1468 | 4,2707 | 5,3945 | 6,7430 |



| Z.9430 (chandelier crystal) | 100x50 mm | 200x50 mm | 300x50 mm | 400x50 mm | 500x50 mm |
|------------------------------------|------------------|------------------|------------------|------------------|------------------|
| BOX pieces | 6 | 6 | 10 | 10 | 10 |
| CARTON pieces | 72 | 72 | 50 | 50 | 50 |
| CRYSTAL CLEAR | 7,2172 | 7,6195 | 9,1339 | 10,1475 | 10,9086 |
| CRYSTAL AB | 14,8896 | 19,8399 | 26,4997 | 33,7559 | 42,8783 |
| CRYSTAL AFLAME | 14,8896 | 19,8399 | 26,4997 | 33,7559 | 42,8783 |
| CRYSTAL AMBER | 14,8896 | 19,8399 | 26,4997 | 33,7559 | 42,8783 |
| CRYSTAL ANTIQUE | 14,8896 | 19,8399 | 26,4997 | 33,7559 | 42,8783 |
| CRYSTAL GOLD | 14,8896 | 19,8399 | 26,4997 | 33,7559 | 42,8783 |
| CRYSTAL SILVER | 14,8896 | 19,8399 | 26,4997 | 33,7559 | 42,8783 |
| ALEXANDRITE | 14,4344 | 15,2389 | 18,2678 | 20,2949 | 21,8172 |
| AMETHYST | 14,4344 | 15,2389 | 18,2678 | 20,2949 | 21,8172 |
| AQUAMARINE | 14,4344 | 15,2389 | 18,2678 | 20,2949 | 21,8172 |
| EMERALD | 14,4344 | 15,2389 | 18,2678 | 20,2949 | 21,8172 |
| JET | 14,4344 | 15,2389 | 18,2678 | 20,2949 | 21,8172 |
| ROSALIN | 14,4344 | 15,2389 | 18,2678 | 20,2949 | 21,8172 |
| RUBY | 14,4344 | 15,2389 | 18,2678 | 20,2949 | 21,8172 |
| SAPPHIRE | 14,4344 | 15,2389 | 18,2678 | 20,2949 | 21,8172 |
| SMOKE | 14,4344 | 15,2389 | 18,2678 | 20,2949 | 21,8172 |
| TOPAZ | 14,4344 | 15,2389 | 18,2678 | 20,2949 | 21,8172 |

| EURO piece | EURO piece | EURO piece | EURO piece | EURO piece |
|---------------|---------------|---------------|---------------|---------------|
|---------------|---------------|---------------|---------------|---------------|



| Z.9410 (chandelier crystal) | 55x13 mm | 75x16 mm | 100x19 mm | 125x22 mm | 160x22 mm |
|------------------------------------|-----------------|-----------------|------------------|------------------|------------------|
| BOX pieces | 400 | 200 | 54 | 30 | 30 |
| CARTON pieces | 4.800 | 2.400 | 648 | 360 | 360 |
| CRYSTAL CLEAR | 1,3427 | 1,4037 | 1,4851 | 1,8920 | 1,8920 |
| CRYSTAL AB | 1,7640 | 2,0396 | 2,3049 | 2,9370 | 2,9370 |
| CRYSTAL AFLAME | 1,7640 | 2,0396 | 2,3049 | 2,9370 | 2,9370 |
| CRYSTAL AMBER | 1,7640 | 2,0396 | 2,3049 | 2,9370 | 2,9370 |
| CRYSTAL ANTIQUE | 1,7640 | 2,0396 | 2,3049 | 2,9370 | 2,9370 |
| CRYSTAL GOLD | 1,7640 | 2,0396 | 2,3049 | 2,9370 | 2,9370 |
| CRYSTAL SILVER | 1,7640 | 2,0396 | 2,3049 | 2,9370 | 2,9370 |
| ALEXANDRITE | 1,3427 | 1,4037 | 1,4851 | 1,8920 | 1,8920 |
| AMETHYST | 1,3427 | 1,4037 | 1,4851 | 1,8920 | 1,8920 |
| AQUAMARINE | 1,3427 | 1,4037 | 1,4851 | 1,8920 | 1,8920 |
| EMERALD | 1,3427 | 1,4037 | 1,4851 | 1,8920 | 1,8920 |
| JET | 1,3427 | 1,4037 | 1,4851 | 1,8920 | 1,8920 |
| ROSALIN | 1,3427 | 1,4037 | 1,4851 | 1,8920 | 1,8920 |
| RUBY | 1,3427 | 1,4037 | 1,4851 | 1,8920 | 1,8920 |
| SAPPHIRE | 1,3427 | 1,4037 | 1,4851 | 1,8920 | 1,8920 |
| SMOKE | 1,3427 | 1,4037 | 1,4851 | 1,8920 | 1,8920 |
| TOPAZ | 1,3427 | 1,4037 | 1,4851 | 1,8920 | 1,8920 |

| 200x24 mm | 250x26 mm |
|------------------|------------------|
|------------------|------------------|

| | | |
|----------------------|--------|---------|
| BOX pieces | 20 | 20 |
| CARTON pieces | 240 | 240 |
| CRYSTAL CLEAR | 2,9092 | 3,7026 |
| CRYSTAL AB | 8,6491 | 11,8530 |
| CRYSTAL AFLAME | 8,6491 | 11,8530 |
| CRYSTAL AMBER | 8,6491 | 11,8530 |
| CRYSTAL ANTIQUE | 8,6491 | 11,8530 |
| CRYSTAL GOLD | 8,6491 | 11,8530 |
| CRYSTAL SILVER | 8,6491 | 11,8530 |
| ALEXANDRITE | 2,9092 | 3,7026 |
| AMETHYST | 2,9092 | 3,7026 |
| AQUAMARINE | 2,9092 | 3,7026 |
| EMERALD | 2,9092 | 3,7026 |
| JET | 2,9092 | 3,7026 |
| ROSALIN | 2,9092 | 3,7026 |
| RUBY | 2,9092 | 3,7026 |
| SAPPHIRE | 2,9092 | 3,7026 |
| SMOKE | 2,9092 | 3,7026 |
| TOPAZ | 2,9092 | 3,7026 |



| Z.9433 (chandelier crystal) | 160x15 mm |
|------------------------------------|------------------|
| BOX pieces | 32 |
| CARTON pieces | 384 |
| CRYSTAL CLEAR | 2,1772 |
| CRYSTAL AB | 3,7395 |
| CRYSTAL AFLAME | 3,7395 |
| CRYSTAL AMBER | 3,7395 |
| CRYSTAL ANTIQUE | 3,7395 |
| CRYSTAL GOLD | 3,7395 |
| CRYSTAL SILVER | 3,7395 |

**Z.9440 - apple (chandelier crystal)**

| | | EURO piece | minimum quantity BOX pieces | CARTON pieces |
|-------|-----------------|---------------|--------------------------------------|------------------|
| 35 mm | CRYSTAL CLEAR | 3,0959 | 30 | 360 |
| 35 mm | CRYSTAL FROSTED | 3,7995 | 30 | 360 |
| 35 mm | EMERALD | 3,7995 | 30 | 360 |
| 35 mm | RUBY | 3,7995 | 30 | 360 |

**Z.9441 - pear (chandelier crystal)**

| | | | | |
|-------|-----------------|--------|----|-----|
| 50 mm | CRYSTAL CLEAR | 3,2648 | 30 | 360 |
| 50 mm | CRYSTAL FROSTED | 4,2780 | 30 | 360 |
| 50 mm | EMERALD | 4,2780 | 30 | 360 |
| 50 mm | TOPAZ | 4,2780 | 30 | 360 |

**Z.9442 - apricot (chandelier crystal)**

| | | | | |
|-------|-----------------|--------|----|-----|
| 35 mm | CRYSTAL CLEAR | 2,9552 | 30 | 360 |
| 35 mm | CRYSTAL FROSTED | 3,9965 | 30 | 360 |
| 35 mm | EMERALD | 3,9965 | 30 | 360 |
| 35 mm | TOPAZ | 3,9965 | 30 | 360 |

**Z.9443 - plum (chandelier crystal)**

| | | | | |
|-------|-----------------|--------|----|-----|
| 38 mm | CRYSTAL CLEAR | 2,3641 | 30 | 360 |
| 38 mm | CRYSTAL FROSTED | 3,2929 | 30 | 360 |
| 38 mm | EMERALD | 3,2929 | 30 | 360 |
| 38 mm | AMETHYST | 3,2929 | 30 | 360 |

**Z.9444 - cherry (chandelier crystal)**

| | | | | |
|-------|-----------------|--------|----|-----|
| 24 mm | CRYSTAL CLEAR | 2,2234 | 30 | 360 |
| 24 mm | CRYSTAL FROSTED | 2,9270 | 30 | 360 |
| 24 mm | EMERALD | 2,9270 | 30 | 360 |
| 24 mm | RUBY | 2,9270 | 30 | 360 |

**Z.9445 - nut (chandelier crystal)**

| | | | | |
|-------|-----------------|--------|----|-----|
| 32 mm | CRYSTAL CLEAR | 2,3641 | 30 | 360 |
| 32 mm | CRYSTAL FROSTED | 3,0959 | 30 | 360 |
| 32 mm | EMERALD | 3,0959 | 30 | 360 |
| 32 mm | TOPAZ | 3,0959 | 30 | 360 |

**Z.9446 - strawberry (chandelier crystal)**

| | | | | |
|-------|-----------------|--------|----|-----|
| 23 mm | CRYSTAL CLEAR | 1,9983 | 30 | 360 |
| 23 mm | CRYSTAL FROSTED | 2,7300 | 30 | 360 |
| 23 mm | EMERALD | 2,7300 | 30 | 360 |
| 23 mm | RUBY | 2,7300 | 30 | 360 |

**Z.9447 - raspberry (chandelier crystal)**

| | | | | |
|-------|-----------------|--------|----|-----|
| 19 mm | CRYSTAL CLEAR | 1,5761 | 30 | 360 |
| 19 mm | CRYSTAL FROSTED | 2,2797 | 30 | 360 |
| 19 mm | EMERALD | 2,2797 | 30 | 360 |
| 19 mm | RUBY | 2,2797 | 30 | 360 |

| | EURO piece | minimum quantity BOX pieces | CARTON pieces |
|--|---------------|--------------------------------------|------------------|
|--|---------------|--------------------------------------|------------------|



Z.9448 - grape (chandelier crystal)

| | | | | |
|----------|-----------------|---------|----|-----|
| 40x40 mm | CRYSTAL CLEAR | 3,5971 | 25 | 300 |
| 40x40 mm | CRYSTAL FROSTED | 4,0689 | 25 | 300 |
| 40x40 mm | EMERALD | 4,0689 | 25 | 300 |
| 60x40 mm | CRYSTAL CLEAR | 9,3467 | 25 | 300 |
| 60x40 mm | CRYSTAL FROSTED | 10,9388 | 25 | 300 |
| 60x40 mm | EMERALD | 10,9388 | 25 | 300 |
| 60x40 mm | AMETHYST | 10,9388 | 25 | 300 |
| 80x40 mm | CRYSTAL CLEAR | 13,9168 | 25 | 300 |
| 80x40 mm | CRYSTAL FROSTED | 16,5704 | 25 | 300 |
| 80x40 mm | EMERALD | 16,5704 | 25 | 300 |
| 80x40 mm | AMETHYST | 16,5704 | 25 | 300 |



Z.9436 - leave (chandelier crystal)

| | | | | |
|----------|-----------------|--------|-----|-------|
| 22x19 mm | CRYSTAL CLEAR | 0,3891 | 100 | 1.200 |
| 22x19 mm | CRYSTAL FROSTED | 0,4447 | 100 | 1.200 |
| 22x19 mm | EMERALD | 0,4447 | 100 | 1.200 |
| 22x19 mm | TOPAZ | 0,4447 | 100 | 1.200 |
| 36x30 mm | EMERALD | 0,9171 | 100 | 1.200 |



Z.9435 - leave (chandelier crystal)

| | | | | |
|----------|-----------------|--------|-----|-------|
| 33x21 mm | CRYSTAL CLEAR | 0,6353 | 100 | 1.200 |
| 33x21 mm | CRYSTAL FROSTED | 0,9171 | 100 | 1.200 |
| 33x21 mm | EMERALD | 0,9171 | 100 | 1.200 |
| 33x21 mm | TOPAZ | 0,9171 | 100 | 1.200 |



Z.9490 - bird (chandelier crystal) ... center-hole for hanging: approx. 2mm

| | | | | |
|--------|-----------------|---------|---|----|
| 100 mm | CRYSTAL CLEAR | 13,8064 | 3 | 36 |
| 100 mm | CRYSTAL AB | 24,0389 | 3 | 36 |
| 100 mm | CRYSTAL AFLAME | 24,0389 | 3 | 36 |
| 100 mm | CRYSTAL AMBER | 24,0389 | 3 | 36 |
| 100 mm | CRYSTAL ANTIQUE | 24,0389 | 3 | 36 |
| 100 mm | CRYSTAL GOLD | 24,0389 | 3 | 36 |
| 100 mm | CRYSTAL SILVER | 24,0389 | 3 | 36 |

| | minimum quantity | |
|------------|------------------|---------------|
| EURO piece | BOX pieces | CARTON pieces |

RODS

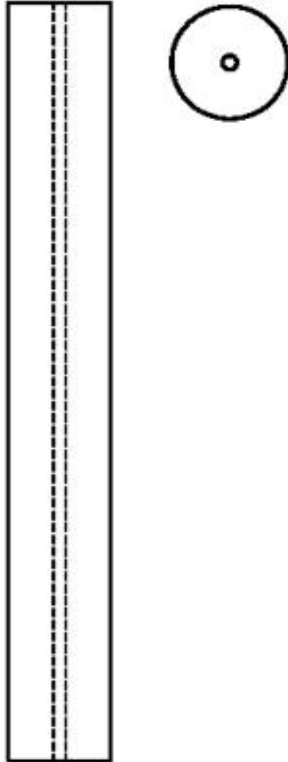

Z.9450 (chandelier crystal)

diameter: 6 mm - center-hole: Ø 2.75mm

| | | | | |
|-------------------|--------------------|------------|------|--------|
| 30 mm | CRYSTAL CLEAR | 0,1461 | 3000 | 36.000 |
| 30 mm | CRYSTAL WHITE-OPAL | 0,1461 | 3000 | 36.000 |
| 40 mm | CRYSTAL CLEAR | 0,1791 | 3000 | 36.000 |
| 40 mm | CRYSTAL WHITE-OPAL | 0,1791 | 3000 | 36.000 |
| 50 mm | CRYSTAL CLEAR | 0,2041 | 3000 | 36.000 |
| 50 mm | CRYSTAL WHITE-OPAL | 0,2041 | 3000 | 36.000 |
| 60 mm | CRYSTAL CLEAR | 0,2193 | 3000 | 36.000 |
| 60 mm | CRYSTAL WHITE-OPAL | 0,2193 | 3000 | 36.000 |
| 70 mm | CRYSTAL CLEAR | 0,2528 | 3000 | 36.000 |
| 70 mm | CRYSTAL WHITE-OPAL | 0,2528 | 3000 | 36.000 |
| 80 mm | CRYSTAL CLEAR | 0,2830 | 1000 | 12.000 |
| 80 mm | CRYSTAL WHITE-OPAL | 0,2830 | 1000 | 12.000 |
| 100 mm | CRYSTAL CLEAR | 0,3438 | 1000 | 12.000 |
| 100 mm | CRYSTAL WHITE-OPAL | 0,3438 | 1000 | 12.000 |
| 125 mm | CRYSTAL CLEAR | 0,4255 | 1000 | 12.000 |
| 125 mm | CRYSTAL WHITE-OPAL | 0,4255 | 1000 | 12.000 |
| 150 mm | CRYSTAL CLEAR | 0,5072 | 1000 | 12.000 |
| 150 mm | CRYSTAL WHITE-OPAL | 0,5072 | 1000 | 12.000 |
| 200 mm | CRYSTAL CLEAR | 0,6615 | 1000 | 12.000 |
| 200 mm | CRYSTAL WHITE-OPAL | 0,6615 | 1000 | 12.000 |
| + other lengths : | | on request | | |

diameter: 8 mm - center-hole: Ø 1.25mm

| | | | | |
|---|---------------|------------|-----|-------|
| 50 mm | CRYSTAL CLEAR | 3,5173 | 100 | 1.200 |
| 75 mm | CRYSTAL CLEAR | 3,6602 | 100 | 1.200 |
| 100 mm | CRYSTAL CLEAR | 3,7746 | 100 | 1.200 |
| 125 mm | CRYSTAL CLEAR | 4,3188 | 100 | 1.200 |
| 150 mm | CRYSTAL CLEAR | 4,4793 | 100 | 1.200 |
| 200 mm | CRYSTAL CLEAR | 4,7316 | 100 | 1.200 |
| + other lengths : | | on request | | |
| + other diameters (4/5/6/7/9mm) : | | on request | | |
| + other center-holes (0.75/1.75/2.25/2.75mm): | | on request | | |

diameter: 27 mm - center-hole: Ø 1.75mm

| | | | | |
|-------------------|---------------|------------|-----|-------|
| 50 mm | CRYSTAL CLEAR | 6,3358 | 100 | 1.200 |
| 75 mm | CRYSTAL CLEAR | 8,1509 | 100 | 1.200 |
| 100 mm | CRYSTAL CLEAR | 10,2594 | 100 | 1.200 |
| 125 mm | CRYSTAL CLEAR | 10,9081 | 100 | 1.200 |
| 150 mm | CRYSTAL CLEAR | 11,5534 | 100 | 1.200 |
| 200 mm | CRYSTAL CLEAR | 12,8475 | 100 | 1.200 |
| + other lengths : | | on request | | |

... for fixing, use wire inside, twist wire on top and on bottom !

... suitable for hanging prisms at the lower end !

| | minimum quantity | |
|------------|------------------|---------------|
| EURO piece | BOX pieces | CARTON pieces |

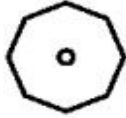
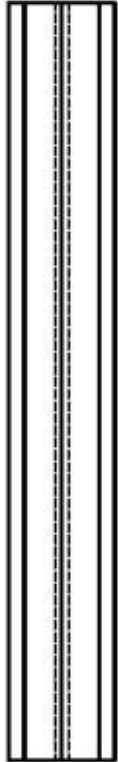

Z.9452 (chandelier crystal)

diameter: 14 mm - center-hole: Ø 2.00mm

| | | | | |
|-------------------|---------------|------------|-----|-------|
| 50 mm | CRYSTAL CLEAR | 0,6397 | 100 | 1.200 |
| 75 mm | CRYSTAL CLEAR | 0,8585 | 100 | 1.200 |
| 100 mm | CRYSTAL CLEAR | 0,9932 | 100 | 1.200 |
| 125 mm | CRYSTAL CLEAR | 1,2457 | 100 | 1.200 |
| 150 mm | CRYSTAL CLEAR | 1,4645 | 100 | 1.200 |
| 200 mm | CRYSTAL CLEAR | 1,8180 | 100 | 1.200 |
| 250 mm | CRYSTAL CLEAR | 2,2388 | 100 | 1.200 |
| 500 mm | CRYSTAL CLEAR | 5,9254 | 100 | 1.200 |
| 1000 mm | CRYSTAL CLEAR | 9,6960 | 100 | 1.200 |
| + other lengths : | | on request | | |

... for fixing, use wire inside, twist wire on top and on bottom !

... suitable for hanging prisms at the lower end !

| CRYSTAL | CRYSTAL | CRYSTAL | minimum quantity | |
|------------|------------|------------|------------------|---------------|
| CLEAR | CLEAR | CLEAR | | |
| EURO piece | EURO piece | EURO piece | BOX pieces | CARTON pieces |

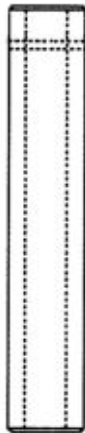
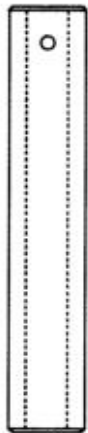

Z.9456 (chandelier crystal)

| | <u>dia. 18 mm</u> hole: Ø 10mm | <u>dia. 21 mm</u> hole: Ø 11mm | <u>dia. 24 mm</u> hole: Ø 12mm | <u>hanging-hole: Ø 3.0mm</u> | |
|---------|-----------------------------------|-----------------------------------|-----------------------------------|------------------------------|-------|
| 100 mm | 2,5407 | 2,8852 | 3,7695 | 100 | 1.200 |
| 150 mm | 2,9782 | 3,4760 | 4,6840 | 100 | 1.200 |
| 200 mm | 3,3845 | 4,0245 | 5,5333 | 100 | 1.200 |
| 250 mm | 3,8316 | 4,6280 | 6,4673 | 100 | 1.200 |
| 300 mm | 4,2637 | 5,2113 | 7,3706 | 100 | 1.200 |
| 350 mm | 4,7559 | 5,8759 | 8,3994 | 100 | 1.200 |
| 400 mm | 5,4245 | 6,7511 | 9,7197 | 100 | 1.200 |
| 450 mm | 5,9644 | 7,4800 | 10,8480 | 100 | 1.200 |
| 500 mm | 6,4337 | 8,1136 | 11,8289 | 100 | 1.200 |
| 550 mm | 6,8603 | 8,6895 | 12,7207 | 100 | 1.200 |
| 600 mm | 7,3937 | 9,4095 | 13,8352 | 100 | 1.200 |
| 650 mm | 7,8368 | 10,0077 | 14,7612 | 100 | 1.200 |
| 700 mm | 8,3536 | 10,7056 | 15,8414 | 100 | 1.200 |
| 750 mm | 8,8706 | 11,4034 | 16,9219 | 100 | 1.200 |
| 800 mm | 9,3242 | 12,0159 | 17,8852 | 100 | 1.200 |
| 850 mm | 9,8412 | 12,7137 | 18,9505 | 100 | 1.200 |
| 900 mm | 10,2948 | 13,3263 | 19,8986 | 100 | 1.200 |
| 950 mm | 10,7642 | 13,9597 | 20,8797 | 100 | 1.200 |
| 1000 mm | 11,2335 | 14,5933 | 21,8605 | 100 | 1.200 |

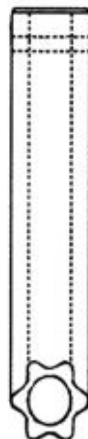
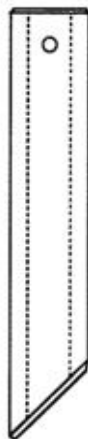

Z.9457 (chandelier crystal)

| | <u>dia. 18 mm</u> hole: Ø 10mm | <u>dia. 21 mm</u> hole: Ø 11mm | <u>dia. 24 mm</u> hole: Ø 12mm | <u>bottom: 45 degree</u> <u>hanging-hole: Ø 3.0mm</u> | |
|---------|-----------------------------------|-----------------------------------|-----------------------------------|--|-------|
| 100 mm | 2,7346 | 3,0792 | 3,9827 | 100 | 1.200 |
| 150 mm | 3,1722 | 3,6700 | 4,8973 | 100 | 1.200 |
| 200 mm | 3,5785 | 4,2185 | 5,7466 | 100 | 1.200 |
| 250 mm | 4,0254 | 4,8219 | 6,6808 | 100 | 1.200 |
| 300 mm | 4,4577 | 5,4052 | 7,5839 | 100 | 1.200 |
| 350 mm | 4,9499 | 6,0699 | 8,6128 | 100 | 1.200 |
| 400 mm | 5,6281 | 6,9549 | 9,9437 | 100 | 1.200 |
| 450 mm | 6,1680 | 7,6836 | 11,0720 | 100 | 1.200 |
| 500 mm | 6,6374 | 8,3173 | 12,0528 | 100 | 1.200 |
| 550 mm | 7,0640 | 8,8932 | 12,9446 | 100 | 1.200 |
| 600 mm | 7,5974 | 9,6131 | 14,0592 | 100 | 1.200 |
| 650 mm | 8,0404 | 10,2113 | 14,9852 | 100 | 1.200 |
| 700 mm | 8,5572 | 10,9092 | 16,0654 | 100 | 1.200 |
| 750 mm | 9,0742 | 11,6070 | 17,1459 | 100 | 1.200 |
| 800 mm | 9,5278 | 12,2195 | 18,0941 | 100 | 1.200 |
| 850 mm | 10,0448 | 12,9174 | 19,1746 | 100 | 1.200 |
| 900 mm | 10,4985 | 13,5299 | 20,5149 | 100 | 1.200 |
| 950 mm | 10,9678 | 14,1635 | 21,1036 | 100 | 1.200 |
| 1000 mm | 11,4371 | 14,7970 | 22,0845 | 100 | 1.200 |

| CRYSTAL | CRYSTAL | CRYSTAL | minimum quantity | |
|------------|------------|------------|------------------|---------------|
| CLEAR | CLEAR | CLEAR | | |
| EURO piece | EURO piece | EURO piece | BOX pieces | CARTON pieces |

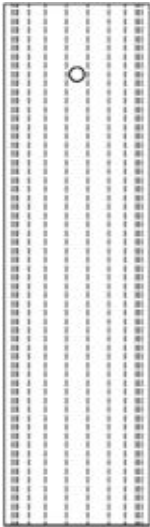

Z.9458 (chandelier crystal)

| | <u>dia. 50 mm</u> <u>hole: Ø 45mm</u> | <u>dia. 60 mm</u> <u>hole: Ø 55mm</u> | <u>dia. 80 mm</u> <u>hole: Ø 75mm</u> | <u>hanging-holes: Ø 3.0mm</u> | |
|---------|--|--|--|-------------------------------|-----|
| 100 mm | 6,6530 | 6,9773 | 8,2489 | 10 | 120 |
| 150 mm | 7,5432 | 8,0295 | 9,9370 | 10 | 120 |
| 200 mm | 8,4333 | 9,0818 | 11,6251 | 10 | 120 |
| 250 mm | 9,3234 | 10,1340 | 13,3131 | 10 | 120 |
| 300 mm | 10,2135 | 11,1863 | 15,0012 | 10 | 120 |
| 350 mm | 11,1036 | 12,2385 | 16,6893 | 10 | 120 |
| 400 mm | 11,9938 | 13,2907 | 18,3773 | 10 | 120 |
| 450 mm | 12,8839 | 14,3430 | 20,0654 | 10 | 120 |
| 500 mm | 13,7740 | 15,3952 | 21,7535 | 10 | 120 |
| 550 mm | 14,6641 | 16,4475 | 23,4415 | 10 | 120 |
| 600 mm | 15,5542 | 17,4997 | 25,1296 | 10 | 120 |
| 650 mm | 16,4444 | 18,5519 | 26,8176 | 10 | 120 |
| 700 mm | 17,3345 | 19,6042 | 28,5057 | 10 | 120 |
| 750 mm | 18,2246 | 20,6564 | 30,1938 | 10 | 120 |
| 800 mm | 19,1147 | 21,7087 | 31,8818 | 10 | 120 |
| 850 mm | 20,0048 | 22,7609 | 33,5699 | 10 | 120 |
| 900 mm | 20,8950 | 23,8131 | 35,2580 | 10 | 120 |
| 950 mm | 21,7851 | 24,8654 | 36,9460 | 10 | 120 |
| 1000 mm | 22,6752 | 25,9176 | 38,6341 | 10 | 120 |

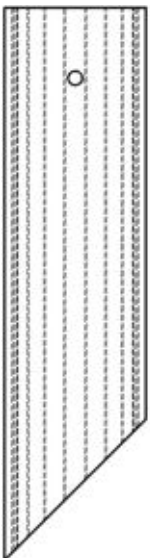

Z.9459 (chandelier crystal)

| | <u>dia. 50 mm</u> <u>hole: Ø 45mm</u> | <u>dia. 60 mm</u> <u>hole: Ø 55mm</u> | <u>dia. 80 mm</u> <u>hole: Ø 75mm</u> | <u>bottom: 45 degree</u> <u>hanging-holes: Ø 3.0mm</u> | |
|---------|--|--|--|---|-----|
| 100 mm | 7,3702 | 7,6945 | 8,9661 | 10 | 120 |
| 150 mm | 8,2604 | 8,7467 | 10,6542 | 10 | 120 |
| 200 mm | 9,1505 | 9,7990 | 12,3423 | 10 | 120 |
| 250 mm | 10,0406 | 10,8512 | 14,0303 | 10 | 120 |
| 300 mm | 10,9307 | 11,9035 | 15,7184 | 10 | 120 |
| 350 mm | 11,8208 | 12,9557 | 17,4065 | 10 | 120 |
| 400 mm | 12,7110 | 14,0079 | 19,0945 | 10 | 120 |
| 450 mm | 13,6011 | 15,0602 | 20,7826 | 10 | 120 |
| 500 mm | 14,4912 | 16,1124 | 22,4707 | 10 | 120 |
| 550 mm | 15,3813 | 17,1647 | 24,1587 | 10 | 120 |
| 600 mm | 16,2714 | 18,2169 | 25,8468 | 10 | 120 |
| 650 mm | 17,1616 | 19,2691 | 27,5348 | 10 | 120 |
| 700 mm | 18,0517 | 20,3214 | 29,2229 | 10 | 120 |
| 750 mm | 18,9418 | 21,3736 | 30,9110 | 10 | 120 |
| 800 mm | 19,8319 | 22,4259 | 32,5990 | 10 | 120 |
| 850 mm | 20,7220 | 23,4781 | 34,2871 | 10 | 120 |
| 900 mm | 21,6122 | 24,5303 | 35,9752 | 10 | 120 |
| 950 mm | 22,5023 | 25,5826 | 37,6632 | 10 | 120 |
| 1000 mm | 23,3924 | 26,6348 | 39,3513 | 10 | 120 |

| | minimum quantity | |
|------------|------------------|---------------|
| EURO piece | BOX pieces | CARTON pieces |

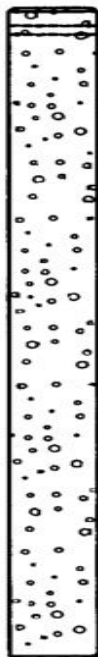

Z.9461 (chandelier crystal)

diameter: 25 mm - WITHOUT HOLE - bubbles: approx. dia. 2.5mm

round

| | | | |
|---------------------|------------|-----------|-------|
| 50 mm | 5,1280 | 100 | 1.200 |
| 75 mm | 6,5290 | 100 | 1.200 |
| 100 mm | 8,3925 | 100 | 1.200 |
| 125 mm | 10,2594 | 100 | 1.200 |
| 150 mm | 12,1228 | 100 | 1.200 |
| 200 mm | 13,5204 | 100 | 1.200 |
| 250 mm | 14,9215 | 100 | 1.200 |
| 300 mm | 16,7815 | 100 | 1.200 |
| + other lengths : | on request | | |
| + other diameters : | on request | | |
| + hole-drilling : | 1,4669 | (Ø 1.5mm) | |

... especially suitable for LED-usages !



Z.9460 (chandelier crystal)

diameter: 25 mm - WITHOUT HOLE - bubbles: approx. dia. 2.5mm

round with 10 facets

| | | | |
|---------------------|------------|-----------|-------|
| 50 mm | 5,1280 | 100 | 1.200 |
| 75 mm | 6,5290 | 100 | 1.200 |
| 100 mm | 8,3925 | 100 | 1.200 |
| 125 mm | 10,2594 | 100 | 1.200 |
| 150 mm | 12,1228 | 100 | 1.200 |
| 200 mm | 13,5204 | 100 | 1.200 |
| 250 mm | 14,9215 | 100 | 1.200 |
| 300 mm | 16,7815 | 100 | 1.200 |
| + other lengths : | on request | | |
| + other diameters : | on request | | |
| + hole-drilling : | 1,4669 | (Ø 1.5mm) | |

... especially suitable for LED-usages !

| | | minimum quantity | |
|--|------------|------------------|---------------|
| | EURO piece | BOX pieces | CARTON pieces |

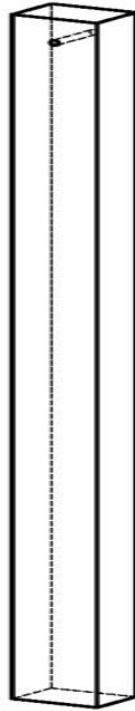

Z.9463 (chandelier crystal)

diameter: 16x12 mm - WITHOUT HOLE

| | | | |
|---------|--------|-----|-------|
| 100 mm | 3,2764 | 100 | 1.200 |
| 150 mm | 3,4802 | 100 | 1.200 |
| 200 mm | 3,6840 | 100 | 1.200 |
| 250 mm | 3,8879 | 100 | 1.200 |
| 300 mm | 4,0917 | 100 | 1.200 |
| 350 mm | 4,2955 | 100 | 1.200 |
| 400 mm | 4,4993 | 100 | 1.200 |
| 450 mm | 4,7031 | 100 | 1.200 |
| 500 mm | 4,9069 | 100 | 1.200 |
| 550 mm | 5,1107 | 100 | 1.200 |
| 600 mm | 5,3145 | 100 | 1.200 |
| 650 mm | 5,5183 | 100 | 1.200 |
| 700 mm | 5,7221 | 100 | 1.200 |
| 750 mm | 5,9260 | 100 | 1.200 |
| 800 mm | 6,1298 | 100 | 1.200 |
| 850 mm | 6,3336 | 100 | 1.200 |
| 900 mm | 6,5374 | 100 | 1.200 |
| 950 mm | 6,7412 | 100 | 1.200 |
| 1000 mm | 6,9450 | 100 | 1.200 |

+ other lengths : on request

+ special cuts : on request

+ hole-drilling : 1,8218 (Ø 1.5mm)



Z.9464 (chandelier crystal)

diameter: 16x12 mm - WITHOUT HOLE

| | | | |
|---------|--------|-----|-------|
| 100 mm | 3,9936 | 100 | 1.200 |
| 150 mm | 4,1974 | 100 | 1.200 |
| 200 mm | 4,4012 | 100 | 1.200 |
| 250 mm | 4,6051 | 100 | 1.200 |
| 300 mm | 4,8089 | 100 | 1.200 |
| 350 mm | 5,0127 | 100 | 1.200 |
| 400 mm | 5,2165 | 100 | 1.200 |
| 450 mm | 5,4203 | 100 | 1.200 |
| 500 mm | 5,6241 | 100 | 1.200 |
| 550 mm | 5,8279 | 100 | 1.200 |
| 600 mm | 6,0317 | 100 | 1.200 |
| 650 mm | 6,2355 | 100 | 1.200 |
| 700 mm | 6,4394 | 100 | 1.200 |
| 750 mm | 6,6432 | 100 | 1.200 |
| 800 mm | 6,8470 | 100 | 1.200 |
| 850 mm | 7,0508 | 100 | 1.200 |
| 900 mm | 7,2546 | 100 | 1.200 |
| 950 mm | 7,4584 | 100 | 1.200 |
| 1000 mm | 7,6622 | 100 | 1.200 |

+ other lengths : on request

+ special cuts : on request

+ hole-drilling : 1,8218 (Ø 1.5mm)

| | minimum quantity | |
|------------|------------------|---------------|
| EURO piece | BOX pieces | CARTON pieces |



Z.9471 (chandelier crystal)

diameter: 5 mm - cap: CHROME

| | | | | |
|--------|-----------------|--------|------|-------|
| 100 mm | CRYSTAL CLEAR | 0,3650 | 300 | 3.600 |
| 100 mm | CRYSTAL FROSTED | 0,4962 | 3600 | 5.000 |
| 150 mm | CRYSTAL CLEAR | 0,5478 | 200 | 2.400 |
| 150 mm | CRYSTAL FROSTED | 0,7443 | 2400 | 5.000 |
| 200 mm | CRYSTAL CLEAR | 0,7455 | 100 | 1.200 |
| 200 mm | CRYSTAL FROSTED | 1,0132 | 1200 | 5.000 |

diameter: 5 mm - cap: GOLD

| | | | | |
|--------|-----------------|--------|------|-------|
| 100 mm | CRYSTAL CLEAR | 0,4380 | 300 | 3.600 |
| 100 mm | CRYSTAL FROSTED | 0,5953 | 3600 | 5.000 |
| 150 mm | CRYSTAL CLEAR | 0,6573 | 200 | 2.400 |
| 150 mm | CRYSTAL FROSTED | 0,8931 | 2400 | 5.000 |
| 200 mm | CRYSTAL CLEAR | 0,8982 | 100 | 1.200 |
| 200 mm | CRYSTAL FROSTED | 1,2206 | 1200 | 5.000 |



Z.9472 (chandelier crystal)

diameter: 5 mm - caps: CHROME

| | | | | |
|--------|-----------------|--------|------|-------|
| 100 mm | CRYSTAL CLEAR | 0,4380 | 300 | 3.600 |
| 100 mm | CRYSTAL FROSTED | 0,5956 | 3600 | 5.000 |
| 150 mm | CRYSTAL CLEAR | 0,6573 | 200 | 2.400 |
| 150 mm | CRYSTAL FROSTED | 0,8931 | 2400 | 5.000 |
| 200 mm | CRYSTAL CLEAR | 0,8541 | 100 | 1.200 |
| 200 mm | CRYSTAL FROSTED | 1,1609 | 1200 | 5.000 |

diameter: 5 mm - caps: GOLD

| | | | | |
|--------|-----------------|--------|------|-------|
| 100 mm | CRYSTAL CLEAR | 0,5256 | 300 | 3.600 |
| 100 mm | CRYSTAL FROSTED | 0,7143 | 3600 | 5.000 |
| 150 mm | CRYSTAL CLEAR | 0,7887 | 200 | 2.400 |
| 150 mm | CRYSTAL FROSTED | 1,0718 | 2400 | 5.000 |
| 200 mm | CRYSTAL CLEAR | 1,0290 | 100 | 1.200 |
| 200 mm | CRYSTAL FROSTED | 1,3986 | 1200 | 5.000 |

| | | |
|-------------------|-------------------|----------------------|
| CRYSTAL | minimum quantity | |
| CLEAR | | |
| EURO piece | BOX pieces | CARTON pieces |



Z.9550 (chandelier crystal)

diameter: 7 mm

| | | | |
|--------|--------|-----|-------|
| 63 mm | 0,6043 | 300 | 3.600 |
| 100 mm | 0,6799 | 300 | 3.600 |
| 125 mm | 0,7932 | 200 | 2.400 |
| 150 mm | 0,8687 | 200 | 2.400 |
| 200 mm | 1,1709 | 100 | 1.200 |
| 250 mm | 1,3597 | 100 | 1.200 |
| 300 mm | 1,5863 | 100 | 1.200 |
| 400 mm | 2,3417 | 100 | 1.200 |



Z.9560 (chandelier crystal)

diameter: 7 mm

| | | | |
|--------|--------|-----|-------|
| 140 mm | 1,0198 | 200 | 2.400 |
| 191 mm | 1,3219 | 100 | 1.200 |
| 292 mm | 1,8129 | 100 | 1.200 |
| 394 mm | 2,4173 | 100 | 1.200 |
| 608 mm | 4,7590 | 100 | 1.200 |

| | | |
|----------------------|----------------------|-------------------------|
| CRYSTAL | minimum quantity | |
| CLEAR | | |
| EURO piece | BOX pieces | CARTON pieces |

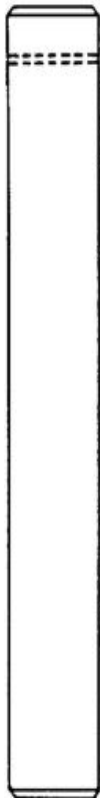

Z.9570 (chandelier crystal)

diameter: 8 mm - WITHOUT HOLE

| | | | |
|--------|--------|-----|-------|
| 100 mm | 3,9870 | 100 | 1.200 |
| 150 mm | 4,2041 | 100 | 1.200 |
| 200 mm | 4,3777 | 100 | 1.200 |
| 250 mm | 4,6903 | 100 | 1.200 |
| 300 mm | 4,9637 | 100 | 1.200 |
| 350 mm | 4,9637 | 100 | 1.200 |
| 400 mm | 5,4196 | 100 | 1.200 |
| 450 mm | 5,4196 | 100 | 1.200 |
| 500 mm | 6,3312 | 100 | 1.200 |

+ other lengths : on request

+ hole-drilling : 1,8218 (Ø 1.5mm)

diameter: 10 mm - WITHOUT HOLE

| | | | |
|--------|--------|-----|-------|
| 100 mm | 4,2079 | 100 | 1.200 |
| 150 mm | 4,5477 | 100 | 1.200 |
| 200 mm | 4,8196 | 100 | 1.200 |
| 250 mm | 5,3089 | 100 | 1.200 |
| 300 mm | 5,7370 | 100 | 1.200 |
| 350 mm | 5,7370 | 100 | 1.200 |
| 400 mm | 6,4506 | 100 | 1.200 |
| 450 mm | 6,4506 | 100 | 1.200 |
| 500 mm | 7,8777 | 100 | 1.200 |

+ other lengths : on request

+ hole-drilling : 1,8218 (Ø 1.5mm)

diameter: 12 mm - WITHOUT HOLE

| | | | |
|--------|--------|-----|-------|
| 100 mm | 4,4754 | 100 | 1.200 |
| 150 mm | 4,9637 | 100 | 1.200 |
| 200 mm | 5,3544 | 100 | 1.200 |
| 250 mm | 6,0577 | 100 | 1.200 |
| 300 mm | 6,6731 | 100 | 1.200 |
| 350 mm | 6,6731 | 100 | 1.200 |
| 400 mm | 7,6987 | 100 | 1.200 |
| 450 mm | 7,6987 | 100 | 1.200 |
| 500 mm | 9,7498 | 100 | 1.200 |

+ other lengths : on request

+ hole-drilling : 1,8218 (Ø 1.5mm)

diameter: 14 mm - WITHOUT HOLE

| | | | |
|--------|---------|-----|-------|
| 100 mm | 4,7940 | 100 | 1.200 |
| 150 mm | 5,4594 | 100 | 1.200 |
| 200 mm | 5,9917 | 100 | 1.200 |
| 250 mm | 6,9498 | 100 | 1.200 |
| 300 mm | 7,7882 | 100 | 1.200 |
| 350 mm | 7,7882 | 100 | 1.200 |
| 400 mm | 9,1855 | 100 | 1.200 |
| 450 mm | 9,1855 | 100 | 1.200 |
| 500 mm | 11,9801 | 100 | 1.200 |

+ other lengths : on request

+ hole-drilling : 1,8218 (Ø 1.5mm)

diameter: 16 mm - WITHOUT HOLE

| | | | |
|--------|---------|-----|-------|
| 100 mm | 5,1591 | 100 | 1.200 |
| 150 mm | 6,0273 | 100 | 1.200 |
| 200 mm | 6,7219 | 100 | 1.200 |
| 250 mm | 7,9721 | 100 | 1.200 |
| 300 mm | 9,0661 | 100 | 1.200 |
| 350 mm | 9,0661 | 100 | 1.200 |
| 400 mm | 10,8894 | 100 | 1.200 |
| 450 mm | 10,8894 | 100 | 1.200 |
| 500 mm | 14,5359 | 100 | 1.200 |

+ other lengths : on request

+ hole-drilling : 1,8218 (Ø 1.5mm)

+ other diameters : on request

+ special cuts : on request

| | | |
|----------------------|----------------------|-------------------------|
| CRYSTAL | minimum quantity | |
| CLEAR | | |
| EURO piece | BOX pieces | CARTON pieces |

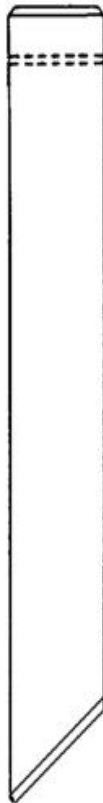

Z.9571 (chandelier crystal)

bottom: 45 degree

diameter: 8 mm - WITHOUT HOLE

| | | | |
|--------|--------|-----|-------|
| 100 mm | 4,8861 | 100 | 1.200 |
| 150 mm | 5,1031 | 100 | 1.200 |
| 200 mm | 5,2768 | 100 | 1.200 |
| 250 mm | 5,5893 | 100 | 1.200 |
| 300 mm | 5,8628 | 100 | 1.200 |
| 350 mm | 5,8628 | 100 | 1.200 |
| 400 mm | 6,3186 | 100 | 1.200 |
| 450 mm | 6,3186 | 100 | 1.200 |
| 500 mm | 7,2303 | 100 | 1.200 |

+ other lengths : on request

+ hole-drilling : 1,8218 (Ø 1.5mm)

diameter: 10 mm - WITHOUT HOLE

| | | | |
|--------|--------|-----|-------|
| 100 mm | 5,1070 | 100 | 1.200 |
| 150 mm | 5,4468 | 100 | 1.200 |
| 200 mm | 5,7186 | 100 | 1.200 |
| 250 mm | 6,2079 | 100 | 1.200 |
| 300 mm | 6,6361 | 100 | 1.200 |
| 350 mm | 6,6361 | 100 | 1.200 |
| 400 mm | 7,3497 | 100 | 1.200 |
| 450 mm | 7,3497 | 100 | 1.200 |
| 500 mm | 8,7768 | 100 | 1.200 |

+ other lengths : on request

+ hole-drilling : 1,8218 (Ø 1.5mm)

diameter: 12 mm - WITHOUT HOLE

| | | | |
|--------|---------|-----|-------|
| 100 mm | 5,3744 | 100 | 1.200 |
| 150 mm | 5,8628 | 100 | 1.200 |
| 200 mm | 6,2535 | 100 | 1.200 |
| 250 mm | 6,9568 | 100 | 1.200 |
| 300 mm | 7,5721 | 100 | 1.200 |
| 350 mm | 7,5721 | 100 | 1.200 |
| 400 mm | 8,5977 | 100 | 1.200 |
| 450 mm | 8,5977 | 100 | 1.200 |
| 500 mm | 10,6489 | 100 | 1.200 |

+ other lengths : on request

+ hole-drilling : 1,8218 (Ø 1.5mm)

diameter: 14 mm - WITHOUT HOLE

| | | | |
|--------|---------|-----|-------|
| 100 mm | 5,6931 | 100 | 1.200 |
| 150 mm | 6,3584 | 100 | 1.200 |
| 200 mm | 6,8907 | 100 | 1.200 |
| 250 mm | 7,8489 | 100 | 1.200 |
| 300 mm | 8,6873 | 100 | 1.200 |
| 350 mm | 8,6873 | 100 | 1.200 |
| 400 mm | 10,0846 | 100 | 1.200 |
| 450 mm | 10,0846 | 100 | 1.200 |
| 500 mm | 12,8792 | 100 | 1.200 |

+ other lengths : on request

+ hole-drilling : 1,8218 (Ø 1.5mm)

diameter: 16 mm - WITHOUT HOLE

| | | | |
|--------|---------|-----|-------|
| 100 mm | 6,0582 | 100 | 1.200 |
| 150 mm | 6,9264 | 100 | 1.200 |
| 200 mm | 7,6210 | 100 | 1.200 |
| 250 mm | 8,8712 | 100 | 1.200 |
| 300 mm | 9,9652 | 100 | 1.200 |
| 350 mm | 9,9652 | 100 | 1.200 |
| 400 mm | 11,7884 | 100 | 1.200 |
| 450 mm | 11,7884 | 100 | 1.200 |
| 500 mm | 15,4350 | 100 | 1.200 |

+ other lengths : on request

+ hole-drilling : 1,8218 (Ø 1.5mm)

+ other diameters : on request

+ special cuts : on request

| | | |
|----------------------|----------------------|-------------------------|
| CRYSTAL | minimum quantity | |
| CLEAR | | |
| EURO piece | BOX pieces | CARTON pieces |

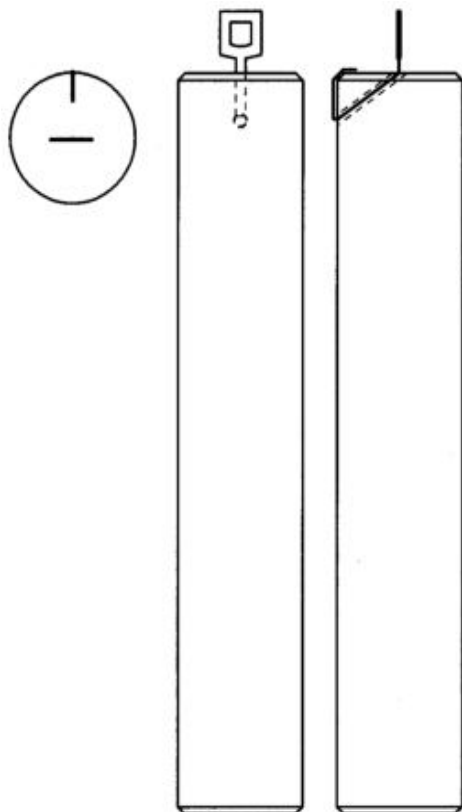

Z.9581 (chandelier crystal)

diameter: 20 mm
safety-suspension: DRILLED HOLE Ø 2.5mm
metal-clip: CHROME-PLATED

| | | | |
|---------|---------|----|-----|
| 100 mm | 4,5216 | 16 | 192 |
| 150 mm | 5,3480 | 12 | 144 |
| 200 mm | 6,1744 | 6 | 72 |
| 250 mm | 7,0007 | 6 | 72 |
| 280 mm | 7,8271 | 6 | 72 |
| 300 mm | 7,8271 | 6 | 72 |
| 350 mm | 8,6535 | 6 | 72 |
| 400 mm | 9,4799 | 6 | 72 |
| 450 mm | 10,3063 | 6 | 72 |
| 500 mm | 11,1327 | 6 | 72 |
| 550 mm | 11,9591 | 6 | 72 |
| 600 mm | 12,7855 | 6 | 72 |
| 650 mm | 13,6118 | 6 | 72 |
| 700 mm | 14,4382 | 6 | 72 |
| 750 mm | 15,2646 | 6 | 72 |
| 800 mm | 16,0910 | 6 | 72 |
| 850 mm | 16,9174 | 6 | 72 |
| 900 mm | 17,7438 | 6 | 72 |
| 950 mm | 18,5702 | 6 | 72 |
| 1000 mm | 19,3966 | 6 | 72 |

+ other lengths : on request

+ special cuts : on request

metal-clip:
GOLD-COLOR
on request (same price)

diameter: 30 mm
safety-suspension: DRILLED HOLE Ø 2.5mm
metal-clip: CHROME-PLATED

| | | | |
|---------|---------|----|-----|
| 100 mm | 6,5883 | 16 | 192 |
| 150 mm | 8,4481 | 12 | 144 |
| 200 mm | 10,3079 | 6 | 72 |
| 250 mm | 12,1676 | 6 | 72 |
| 280 mm | 14,0274 | 6 | 72 |
| 300 mm | 14,0274 | 6 | 72 |
| 350 mm | 15,8872 | 6 | 72 |
| 400 mm | 17,7469 | 6 | 72 |
| 450 mm | 19,6067 | 6 | 72 |
| 500 mm | 21,4665 | 6 | 72 |
| 550 mm | 23,3262 | 6 | 72 |
| 600 mm | 25,1860 | 6 | 72 |
| 650 mm | 27,0458 | 6 | 72 |
| 700 mm | 28,9055 | 6 | 72 |
| 750 mm | 30,7653 | 6 | 72 |
| 800 mm | 32,6251 | 6 | 72 |
| 850 mm | 34,4848 | 6 | 72 |
| 900 mm | 36,3446 | 6 | 72 |
| 950 mm | 38,2044 | 6 | 72 |
| 1000 mm | 40,0641 | 6 | 72 |

+ other lengths : on request

+ special cuts : on request

metal-clip:
GOLD-COLOR
on request (same price)

| | | |
|-------------------|-------------------|----------------------|
| CRYSTAL | minimum quantity | |
| CLEAR | | |
| EURO piece | BOX pieces | CARTON pieces |

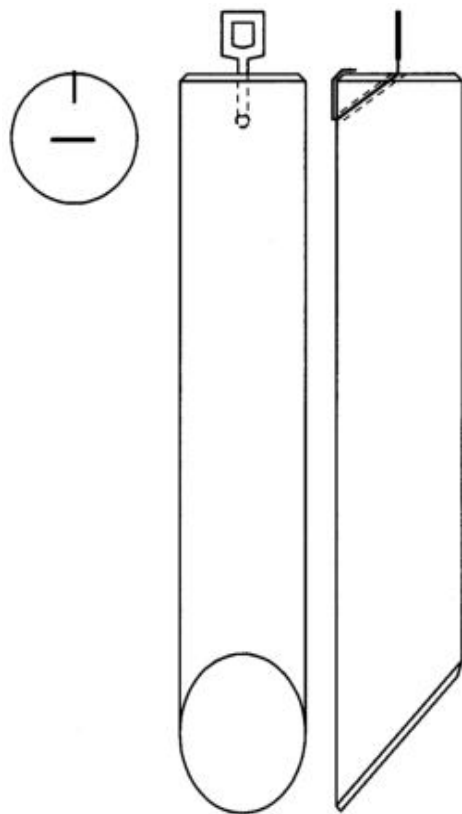

Z.9582 (chandelier crystal)

diameter: 20 mm bottom: 45 degree
safety-suspension: DRILLED HOLE Ø 2.5mm
metal-clip: CHROME-PLATED

| | | | |
|---------|---------|----|-----|
| 100 mm | 5,2388 | 16 | 192 |
| 150 mm | 6,0652 | 12 | 144 |
| 200 mm | 6,8916 | 6 | 72 |
| 250 mm | 7,7179 | 6 | 72 |
| 280 mm | 8,5443 | 6 | 72 |
| 300 mm | 8,5443 | 6 | 72 |
| 350 mm | 9,3707 | 6 | 72 |
| 400 mm | 10,1971 | 6 | 72 |
| 450 mm | 11,0235 | 6 | 72 |
| 500 mm | 11,8499 | 6 | 72 |
| 550 mm | 12,6763 | 6 | 72 |
| 600 mm | 13,5027 | 6 | 72 |
| 650 mm | 14,3290 | 6 | 72 |
| 700 mm | 15,1554 | 6 | 72 |
| 750 mm | 15,9818 | 6 | 72 |
| 800 mm | 16,8082 | 6 | 72 |
| 850 mm | 17,6346 | 6 | 72 |
| 900 mm | 18,4610 | 6 | 72 |
| 950 mm | 19,2874 | 6 | 72 |
| 1000 mm | 20,1180 | 6 | 72 |

+ other lengths : on request

+ special cuts : on request

metal-clip:
GOLD-COLOR
on request (same price)

diameter: 30 mm bottom: 45 degree
safety-suspension: DRILLED HOLE Ø 2.5mm
metal-clip: CHROME-PLATED

| | | | |
|---------|---------|----|-----|
| 100 mm | 7,3055 | 16 | 192 |
| 150 mm | 9,1653 | 12 | 144 |
| 200 mm | 11,0251 | 6 | 72 |
| 250 mm | 12,8848 | 6 | 72 |
| 280 mm | 14,7446 | 6 | 72 |
| 300 mm | 14,7446 | 6 | 72 |
| 350 mm | 16,6044 | 6 | 72 |
| 400 mm | 18,4641 | 6 | 72 |
| 450 mm | 20,3239 | 6 | 72 |
| 500 mm | 22,1837 | 6 | 72 |
| 550 mm | 24,0434 | 6 | 72 |
| 600 mm | 25,9032 | 6 | 72 |
| 650 mm | 27,7630 | 6 | 72 |
| 700 mm | 29,6227 | 6 | 72 |
| 750 mm | 31,4825 | 6 | 72 |
| 800 mm | 33,3423 | 6 | 72 |
| 850 mm | 35,2020 | 6 | 72 |
| 900 mm | 37,0618 | 6 | 72 |
| 950 mm | 38,9216 | 6 | 72 |
| 1000 mm | 40,7813 | 6 | 72 |

+ other lengths : on request

+ special cuts : on request

metal-clip:
GOLD-COLOR
on request (same price)

| | | |
|----------------------|----------------------|-------------------------|
| CRYSTAL | minimum quantity | |
| CLEAR | | |
| EURO piece | BOX pieces | CARTON pieces |

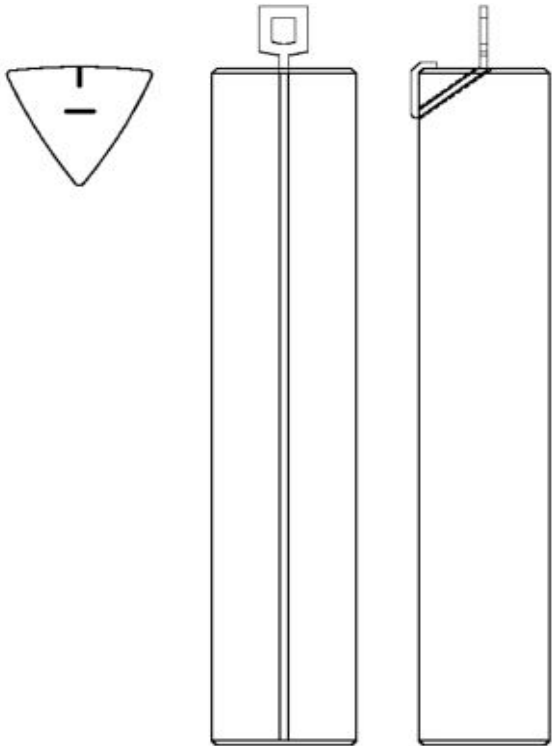

Z.9586 (chandelier crystal)

diameter: 30x30x30 mm
 safety-suspension: DRILLED HOLE Ø 2.5mm
 metal-clip: CHROME-PLATED

| | | | |
|---------|---------|----|-----|
| 100 mm | 4,5861 | 16 | 192 |
| 150 mm | 5,4447 | 12 | 144 |
| 200 mm | 6,3033 | 6 | 72 |
| 250 mm | 7,1620 | 6 | 72 |
| 280 mm | 8,0206 | 6 | 72 |
| 300 mm | 8,0206 | 6 | 72 |
| 350 mm | 8,8792 | 6 | 72 |
| 400 mm | 9,7379 | 6 | 72 |
| 450 mm | 10,5965 | 6 | 72 |
| 500 mm | 11,4552 | 6 | 72 |
| 550 mm | 12,3138 | 6 | 72 |
| 600 mm | 13,1724 | 6 | 72 |
| 650 mm | 14,0311 | 6 | 72 |
| 700 mm | 14,8897 | 6 | 72 |
| 750 mm | 15,7483 | 6 | 72 |
| 800 mm | 16,6070 | 6 | 72 |
| 850 mm | 17,4656 | 6 | 72 |
| 900 mm | 18,3242 | 6 | 72 |
| 950 mm | 19,1829 | 6 | 72 |
| 1000 mm | 20,0415 | 6 | 72 |

+ other lengths : on request

+ special cuts : on request

metal-clip:
GOLD-COLOR
on request (same price)

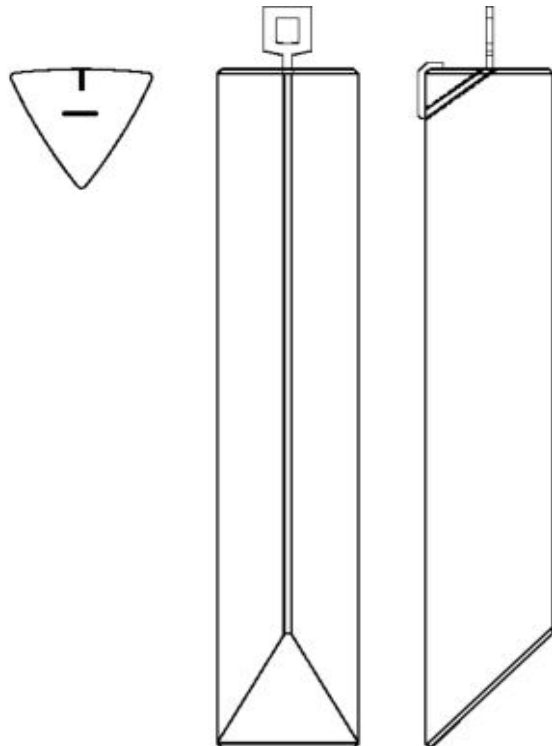

Z.9587 (chandelier crystal)

diameter: 30x30x30 mm bottom: 45 degree
 safety-suspension: DRILLED HOLE Ø 2.5mm
 metal-clip: CHROME-PLATED

| | | | |
|---------|---------|----|-----|
| 100 mm | 5,3033 | 16 | 192 |
| 150 mm | 6,1619 | 12 | 144 |
| 200 mm | 7,0205 | 6 | 72 |
| 250 mm | 7,8792 | 6 | 72 |
| 280 mm | 8,7378 | 6 | 72 |
| 300 mm | 8,7378 | 6 | 72 |
| 350 mm | 9,5964 | 6 | 72 |
| 400 mm | 10,4551 | 6 | 72 |
| 450 mm | 11,3137 | 6 | 72 |
| 500 mm | 12,1724 | 6 | 72 |
| 550 mm | 13,0310 | 6 | 72 |
| 600 mm | 13,8896 | 6 | 72 |
| 650 mm | 14,7483 | 6 | 72 |
| 700 mm | 15,6069 | 6 | 72 |
| 750 mm | 16,4655 | 6 | 72 |
| 800 mm | 17,3242 | 6 | 72 |
| 850 mm | 18,1828 | 6 | 72 |
| 900 mm | 19,0414 | 6 | 72 |
| 950 mm | 19,9001 | 6 | 72 |
| 1000 mm | 20,7587 | 6 | 72 |

+ other lengths : on request

+ special cuts : on request

metal-clip:
GOLD-COLOR
on request (same price)

| | | |
|----------------------|----------------------|-------------------------|
| CRYSTAL | minimum quantity | |
| CLEAR | | |
| EURO piece | BOX pieces | CARTON pieces |

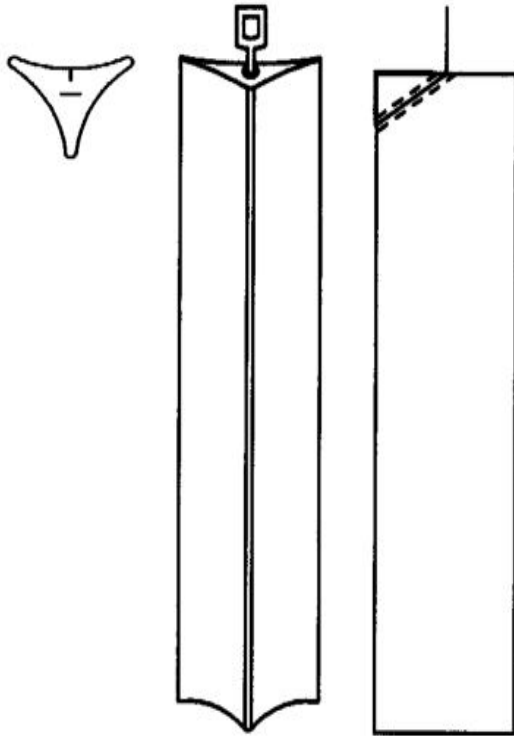

Z.9590 (chandelier crystal)

diameter: 30x30x30 mm
safety-suspension: DRILLED HOLE Ø 2.5mm
metal-clip: CHROME-PLATED

| | | | |
|---------|---------|----|-----|
| 100 mm | 3,4133 | 16 | 192 |
| 150 mm | 4,2943 | 12 | 144 |
| 200 mm | 5,0649 | 6 | 72 |
| 250 mm | 6,0559 | 6 | 72 |
| 280 mm | 6,8265 | 6 | 72 |
| 300 mm | 6,8265 | 6 | 72 |
| 350 mm | 8,1899 | 6 | 72 |
| 400 mm | 9,5741 | 6 | 72 |
| 450 mm | 10,6121 | 6 | 72 |
| 500 mm | 11,6503 | 6 | 72 |
| 550 mm | 12,5731 | 6 | 72 |
| 600 mm | 13,6111 | 6 | 72 |
| 650 mm | 14,5340 | 6 | 72 |
| 700 mm | 15,6874 | 6 | 72 |
| 750 mm | 16,7257 | 6 | 72 |
| 800 mm | 17,6484 | 6 | 72 |
| 850 mm | 18,8020 | 6 | 72 |
| 900 mm | 19,7247 | 6 | 72 |
| 950 mm | 20,7629 | 6 | 72 |
| 1000 mm | 21,6856 | 6 | 72 |

+ other lengths : on request

+ special cuts : on request

metal-clip:
GOLD-COLOR
on request (same price)

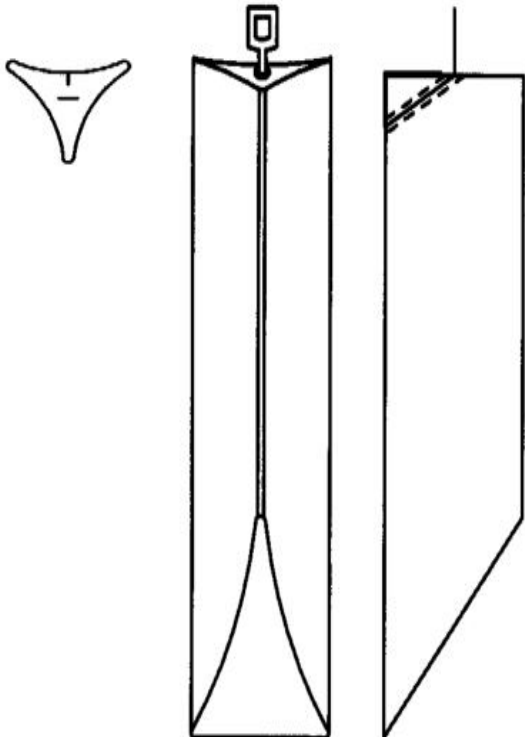

Z.9591 (chandelier crystal)

diameter: 30x30x30 mm bottom: 45 degree
safety-suspension: DRILLED HOLE Ø 2.5mm
metal-clip: CHROME-PLATED

| | | | |
|---------|---------|----|-----|
| 100 mm | 3,6335 | 16 | 192 |
| 150 mm | 4,5145 | 12 | 144 |
| 200 mm | 5,2851 | 6 | 72 |
| 250 mm | 6,1659 | 6 | 72 |
| 280 mm | 7,0467 | 6 | 72 |
| 300 mm | 7,0467 | 6 | 72 |
| 350 mm | 8,4205 | 6 | 72 |
| 400 mm | 9,6893 | 6 | 72 |
| 450 mm | 13,8572 | 6 | 72 |
| 500 mm | 11,8810 | 6 | 72 |
| 550 mm | 12,6884 | 6 | 72 |
| 600 mm | 13,8419 | 6 | 72 |
| 650 mm | 14,7647 | 6 | 72 |
| 700 mm | 15,9182 | 6 | 72 |
| 750 mm | 16,9563 | 6 | 72 |
| 800 mm | 17,8792 | 6 | 72 |
| 850 mm | 18,9172 | 6 | 72 |
| 900 mm | 19,9555 | 6 | 72 |
| 950 mm | 20,8782 | 6 | 72 |
| 1000 mm | 21,9163 | 6 | 72 |

+ other lengths : on request

+ special cuts : on request

metal-clip:
GOLD-COLOR
on request (same price)

| | | |
|-------------------|-------------------|----------------------|
| CRYSTAL | minimum quantity | |
| CLEAR | | |
| EURO piece | BOX pieces | CARTON pieces |

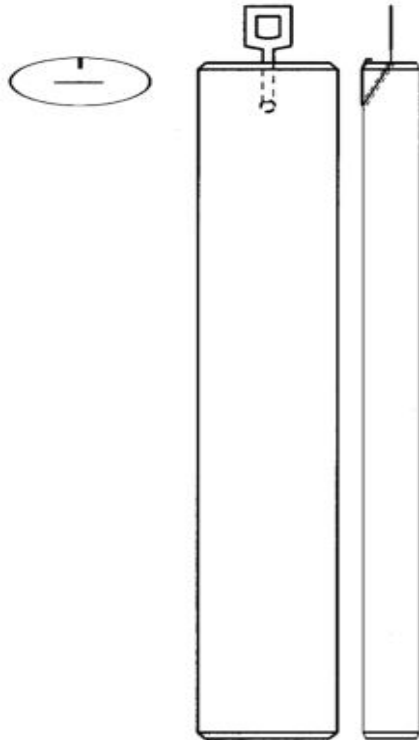

Z.9583 (chandelier crystal)

diameter: 30x12 mm
safety-suspension: DRILLED HOLE Ø 2.5mm
metal-clip: CHROME-PLATED

| | | | |
|---------|---------|----|-----|
| 100 mm | 4,1262 | 16 | 192 |
| 150 mm | 4,7548 | 12 | 144 |
| 200 mm | 5,3835 | 6 | 72 |
| 250 mm | 6,0122 | 6 | 72 |
| 280 mm | 6,6409 | 6 | 72 |
| 300 mm | 6,6409 | 6 | 72 |
| 350 mm | 7,2695 | 6 | 72 |
| 400 mm | 7,8982 | 6 | 72 |
| 450 mm | 8,5269 | 6 | 72 |
| 500 mm | 9,1556 | 6 | 72 |
| 550 mm | 9,7843 | 6 | 72 |
| 600 mm | 10,4129 | 6 | 72 |
| 650 mm | 11,0416 | 6 | 72 |
| 700 mm | 11,6703 | 6 | 72 |
| 750 mm | 12,2990 | 6 | 72 |
| 800 mm | 12,9276 | 6 | 72 |
| 850 mm | 13,5563 | 6 | 72 |
| 900 mm | 14,1850 | 6 | 72 |
| 950 mm | 14,8137 | 6 | 72 |
| 1000 mm | 15,4424 | 6 | 72 |

+ other lengths : on request

+ special cuts : on request

metal-clip:
GOLD-COLOR
on request (same price)

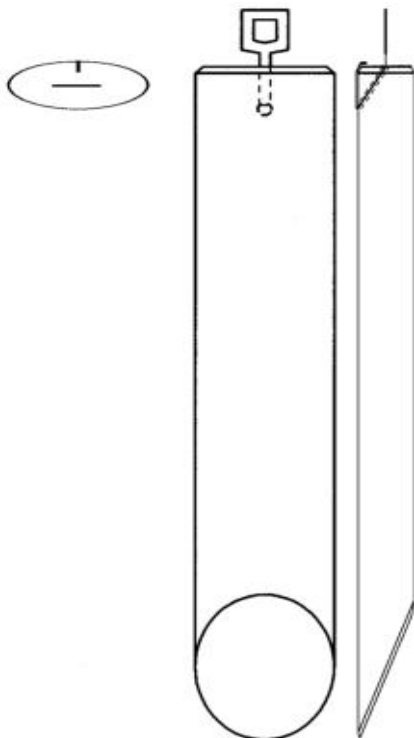

Z.9584 (chandelier crystal)

diameter: 30x12 mm bottom: 45 degree
safety-suspension: DRILLED HOLE Ø 2.5mm
metal-clip: CHROME-PLATED

| | | | |
|---------|---------|----|-----|
| 100 mm | 4,8434 | 16 | 192 |
| 150 mm | 5,4720 | 12 | 144 |
| 200 mm | 6,1007 | 6 | 72 |
| 250 mm | 6,7294 | 6 | 72 |
| 280 mm | 7,3581 | 6 | 72 |
| 300 mm | 7,3581 | 6 | 72 |
| 350 mm | 7,9867 | 6 | 72 |
| 400 mm | 8,6154 | 6 | 72 |
| 450 mm | 9,2441 | 6 | 72 |
| 500 mm | 9,8728 | 6 | 72 |
| 550 mm | 10,5015 | 6 | 72 |
| 600 mm | 11,1301 | 6 | 72 |
| 650 mm | 11,7588 | 6 | 72 |
| 700 mm | 12,3875 | 6 | 72 |
| 750 mm | 13,0162 | 6 | 72 |
| 800 mm | 13,6448 | 6 | 72 |
| 850 mm | 14,2735 | 6 | 72 |
| 900 mm | 14,9022 | 6 | 72 |
| 950 mm | 15,5309 | 6 | 72 |
| 1000 mm | 16,1596 | 6 | 72 |

+ other lengths : on request

+ special cuts : on request

metal-clip:
GOLD-COLOR
on request (same price)

| | | |
|-------------------|-------------------|----------------------|
| CRYSTAL | minimum quantity | |
| CLEAR | | |
| EURO piece | BOX pieces | CARTON pieces |

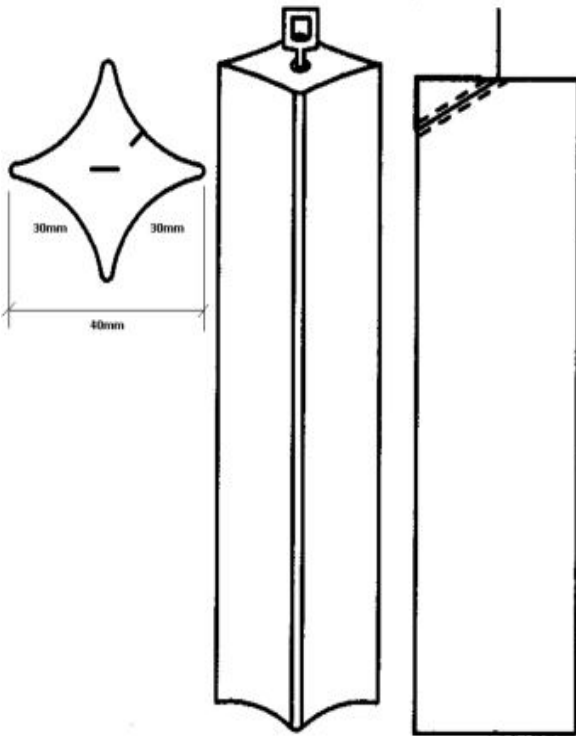

Z.9594 (chandelier crystal)

diameter: 30x30 x40 mm
safety-suspension: DRILLED HOLE Ø 2.5mm
metal-clip: CHROME-PLATED

| | | | |
|---------|---------|----|-----|
| 100 mm | 5,7255 | 16 | 192 |
| 150 mm | 7,5974 | 12 | 144 |
| 200 mm | 9,3590 | 6 | 72 |
| 250 mm | 11,2308 | 6 | 72 |
| 280 mm | 13,1027 | 6 | 72 |
| 300 mm | 13,1027 | 6 | 72 |
| 350 mm | 16,0336 | 6 | 72 |
| 400 mm | 18,6866 | 6 | 72 |
| 450 mm | 21,1089 | 6 | 72 |
| 500 mm | 23,3005 | 6 | 72 |
| 550 mm | 25,1461 | 6 | 72 |
| 600 mm | 27,5684 | 6 | 72 |
| 650 mm | 29,5293 | 6 | 72 |
| 700 mm | 31,9518 | 6 | 72 |
| 750 mm | 34,2587 | 6 | 72 |
| 800 mm | 36,5657 | 6 | 72 |
| 850 mm | 38,6419 | 6 | 72 |
| 900 mm | 40,6027 | 6 | 72 |
| 950 mm | 42,7945 | 6 | 72 |
| 1000 mm | 44,8708 | 6 | 72 |

+ other lengths : on request

+ special cuts : on request

metal-clip:
GOLD-COLOR
on request (same price)

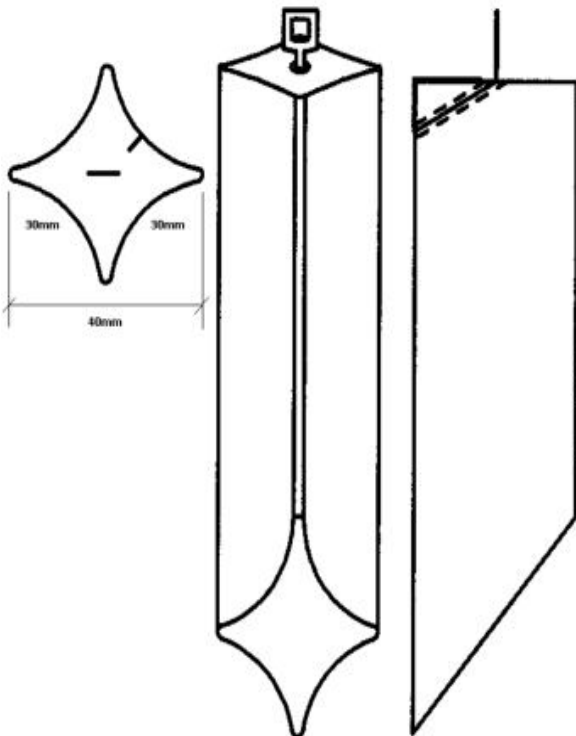

Z.9595 (chandelier crystal)

diameter: 30x30 x40 mm *bottom: 45 degree*
safety-suspension: DRILLED HOLE Ø 2.5mm
metal-clip: CHROME-PLATED

| | | | |
|---------|---------|----|-----|
| 100 mm | 5,9457 | 16 | 192 |
| 150 mm | 7,8176 | 12 | 144 |
| 200 mm | 9,5792 | 6 | 72 |
| 250 mm | 11,4510 | 6 | 72 |
| 280 mm | 13,3229 | 6 | 72 |
| 300 mm | 13,3229 | 6 | 72 |
| 350 mm | 16,1489 | 6 | 72 |
| 400 mm | 18,9172 | 6 | 72 |
| 450 mm | 21,3397 | 6 | 72 |
| 500 mm | 23,5311 | 6 | 72 |
| 550 mm | 25,3768 | 6 | 72 |
| 600 mm | 27,7992 | 6 | 72 |
| 650 mm | 29,7600 | 6 | 72 |
| 700 mm | 32,1824 | 6 | 72 |
| 750 mm | 34,2587 | 6 | 72 |
| 800 mm | 36,7963 | 6 | 72 |
| 850 mm | 38,8726 | 6 | 72 |
| 900 mm | 40,8335 | 6 | 72 |
| 950 mm | 43,0252 | 6 | 72 |
| 1000 mm | 45,1015 | 6 | 72 |

+ other lengths : on request

+ special cuts : on request

metal-clip:
GOLD-COLOR
on request (same price)

| | | |
|-------------------|-------------------|----------------------|
| CRYSTAL | minimum quantity | |
| CLEAR | | |
| EURO piece | BOX pieces | CARTON pieces |

PLATES

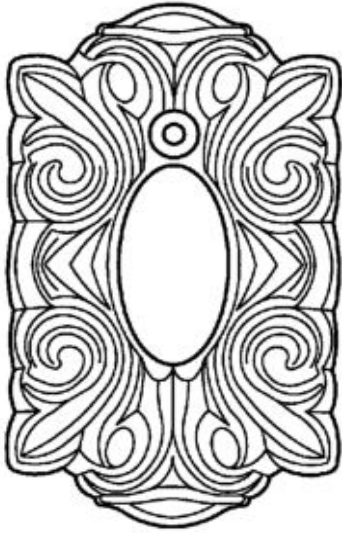

Z.9711 (optic crystal)

size: 120x70 mm
thickness: 10/18 mm
hole: Ø 4.5mm

| | | |
|---------|----|-----|
| 25,6898 | 15 | 180 |
|---------|----|-----|

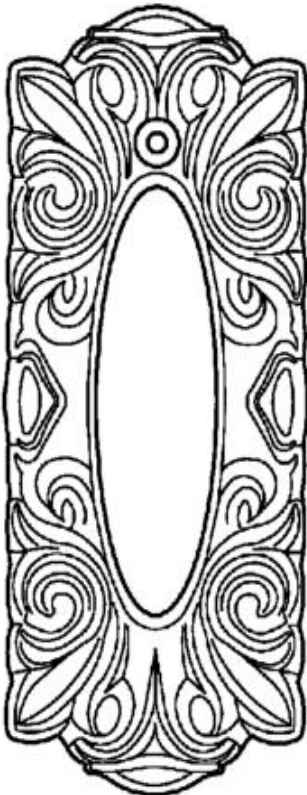

Z.9712 (optic crystal)

size: 160x65 mm
thickness: 10/18 mm
hole: Ø 6.5mm

| | | |
|---------|----|-----|
| 32,7056 | 10 | 120 |
|---------|----|-----|

| CRYSTAL | minimum quantity | |
|------------|------------------|---------------|
| CLEAR | | |
| EURO piece | BOX pieces | CARTON pieces |

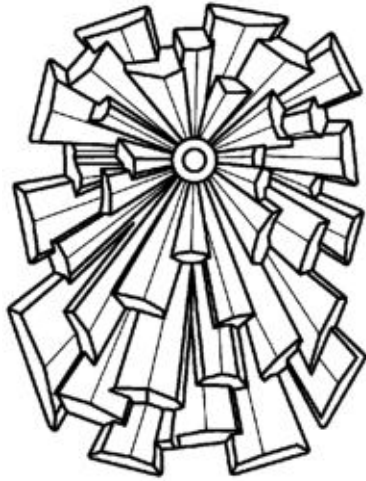

Z.9721 (optic crystal)

size: 105x80 mm
thickness: 12 mm
hole: Ø 4.5mm

| | | |
|---------|----|-----|
| 29,4600 | 15 | 180 |
|---------|----|-----|

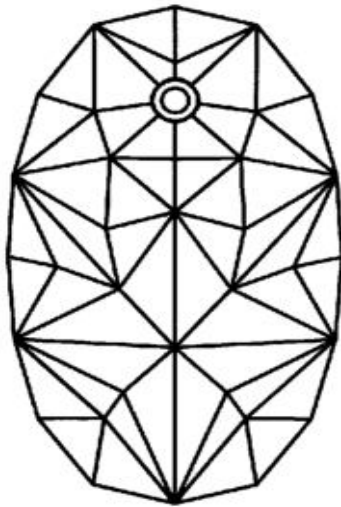

Z.9722 (optic crystal)

size: 120x75 mm
thickness: 20 mm
hole: Ø 5.5mm

| | | |
|---------|----|-----|
| 28,9774 | 15 | 180 |
|---------|----|-----|

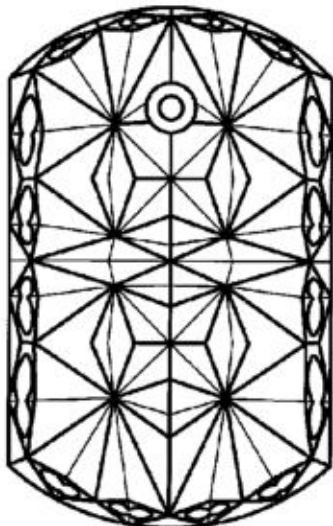

Z.9723 (optic crystal)

size: 120x70 mm
thickness: 20 mm
hole: Ø 5.5mm

| | | |
|---------|----|-----|
| 28,1546 | 15 | 180 |
|---------|----|-----|

| CRYSTAL | minimum quantity | |
|------------|------------------|---------------|
| CLEAR | | |
| EURO piece | BOX pieces | CARTON pieces |

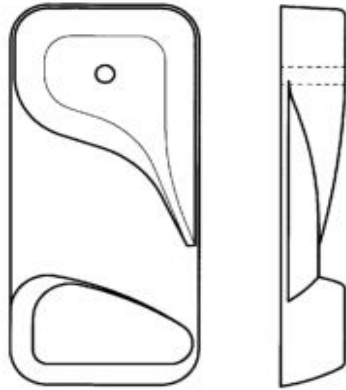

Z.9731 (optic crystal)

size: 110x50 mm
thickness: 18 mm
hole: Ø 4.5mm

| | | |
|---------|----|-----|
| 26,6141 | 15 | 180 |
|---------|----|-----|

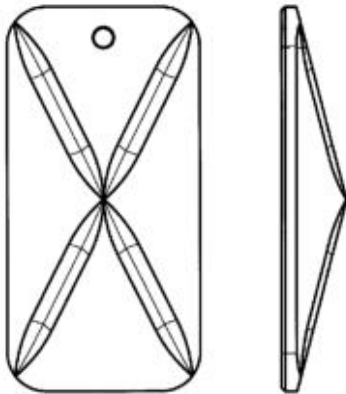

Z.9732 (optic crystal)

size: 100x50 mm
thickness: 18 mm
hole: Ø 5.5mm

| | | |
|---------|----|-----|
| 25,0736 | 15 | 180 |
|---------|----|-----|

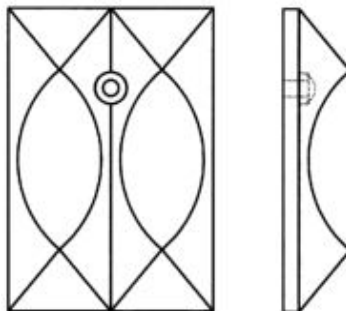

Z.9733 (optic crystal)

size: 95x65 mm
thickness: 20 mm
hole: Ø 4.5mm

| | | |
|---------|----|-----|
| 26,3060 | 15 | 180 |
|---------|----|-----|

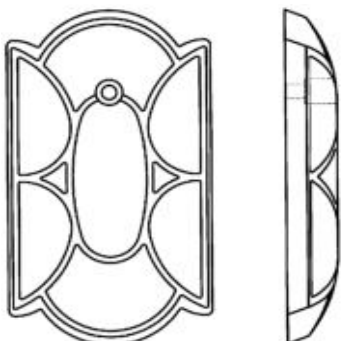

Z.9734 (optic crystal)

size: 120x70 mm
thickness: 18 mm
hole: Ø 5.5mm

| | | |
|---------|----|-----|
| 27,2303 | 15 | 180 |
|---------|----|-----|

| CRYSTAL | minimum quantity | |
|------------|------------------|---------------|
| CLEAR | | |
| EURO piece | BOX pieces | CARTON pieces |

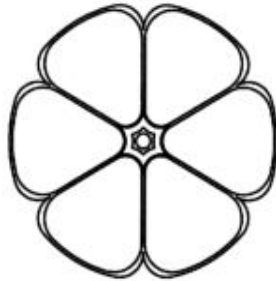

Z.9761 (optic crystal)

size: 90x90 mm
thickness: 14 mm
hole: Ø 5.5mm

| | | |
|---------|----|-----|
| 23,5331 | 15 | 180 |
|---------|----|-----|

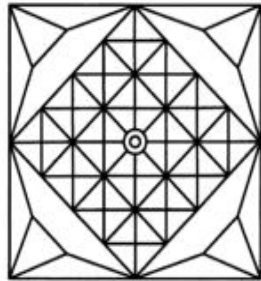

Z.9762 (optic crystal)

size: 100x100 mm
thickness: 17 mm
hole: Ø 5.5mm

| | | |
|---------|----|-----|
| 28,7708 | 12 | 144 |
|---------|----|-----|

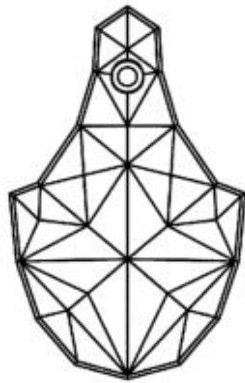

Z.9781 (optic crystal)

size: 120x75 mm
thickness: 20 mm
hole: Ø 5.5mm

| | | |
|---------|----|-----|
| 28,1546 | 15 | 180 |
|---------|----|-----|

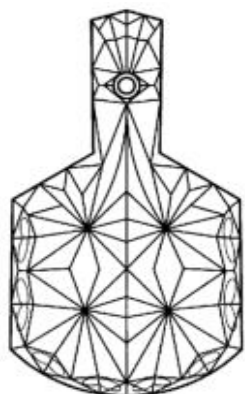

Z.9782 (optic crystal)

size: 120x70 mm
thickness: 20 mm
hole: Ø 5.5mm

| | | |
|---------|----|-----|
| 28,1546 | 15 | 180 |
|---------|----|-----|

| | | |
|-------|--|------------------|
| | | minimum quantity |
| EURO | | CARTON |
| piece | | pieces |

PINNING & CLEANING & GLUEING - ACCESSORIES

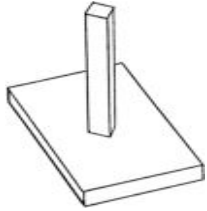

Z.9090 (iron - pinning stand)

| | | |
|---------|----------|---|
| ANGULAR | 187,6448 | 1 |
|---------|----------|---|

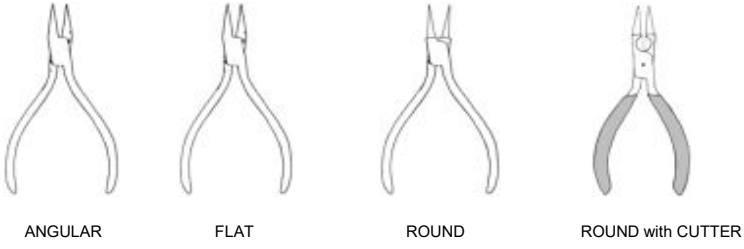

Z.9095 TYPE I (iron - pinning pliers)

| | | |
|-------------------|---------|---|
| ANGULAR | 29,4471 | 1 |
| FLAT | 29,4471 | 1 |
| ROUND | 29,4471 | 1 |
| ROUND with CUTTER | 55,3317 | 1 |



TYPE II

Z.9095 TYPE II (iron - crimping pliers)

| | | |
|-----------------------------|---------|---|
| for cable-end squeeze-rings | 66,3223 | 1 |
|-----------------------------|---------|---|



TYPE III

Z.9095 TYPE III (iron - crimping pliers)

| | | |
|-------------------------------|----------|---|
| for loop-making squeeze-rings | 548,4372 | 1 |
|-------------------------------|----------|---|



Z.9097 (rubber - pinning finger glove)

| | | |
|--------|--------|-----|
| MEDIUM | 0,1516 | 100 |
| LARGE | 0,1516 | 100 |



Z.9098 (cotton - pinning gloves)

| | | |
|-------|--------|---|
| WHITE | 2,6529 | 1 |
|-------|--------|---|

| | | |
|--|------------|------------------|
| | | minimum quantity |
| | EURO piece | CARTON pieces |



Z.9099 (crystal chandelier cleaner)

Type: "Sparkle Plenty"

| | | |
|---------------------------|---------|----|
| LIQUID (0,946 Liter) | 21,0811 | 12 |
|---------------------------|---------|----|



Z.9100 (crystal cleaning cloth)

Type: "Toraysee"

| | | |
|------------------------|---------|---|
| BLUE (190x190 mm) | 10,7673 | 1 |
|------------------------|---------|---|



Z.9900 (SILICONE - glue)

Type: "Wacker"
for glueing ... crystals on tiles etc.

| | | |
|--------------------------|---------|---|
| TRANSPARENT (90 ml) | 32,1183 | 1 |
|--------------------------|---------|---|



Z.9903 (SILICONE - glue)

Type: "Bohle"
for glueing ... mirrors on surfaces etc.

| | | |
|---------------------------|---------|---|
| TRANSPARENT (310 ml) | 12,6454 | 1 |
|---------------------------|---------|---|



Z.9905 (UV - glue)

Type: "Delo"
for glueing ... crystals on crystals

| | | |
|---------------------------------|---------|---|
| TRANSPARENT (50 ml / 50 g) | 68,2894 | 1 |
|---------------------------------|---------|---|



Z.9906 (UV - glue)

Type: "Delo"
for glueing ... crystals on metals

| | | |
|---------------------------------|----------|---|
| TRANSPARENT (50 ml / 50 g) | 105,6659 | 1 |
|---------------------------------|----------|---|

| COLOR | COLOR <u>plated</u> | COLOR <u>plated</u> | minimum quantity |
|---------------|------------------------|------------------------|---------------------|
| BRASS | CHROME | GOLD | |
| EURO piece | EURO piece | EURO piece | BAG pieces |

PINNING MATERIAL

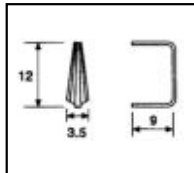

Z.9140 (hanger)

12 mm

| | | | |
|--------|--------|--------|-------|
| 0,0090 | 0,0109 | 0,0490 | 6.090 |
|--------|--------|--------|-------|

15 mm

| | | | |
|--------|--------|--------|-------|
| 0,0136 | 0,0164 | 0,0744 | 4.000 |
|--------|--------|--------|-------|

19 mm

| | | | |
|--------|--------|--------|-------|
| 0,0257 | 0,0299 | 0,1165 | 2.680 |
|--------|--------|--------|-------|

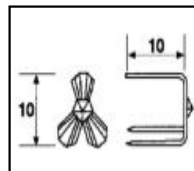
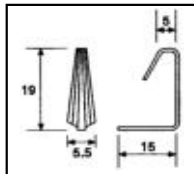
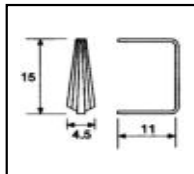

Z.9144 (distributor ... three-legged)

10 mm - three-legged

| | | | |
|--------|--------|--------|-------|
| 0,0272 | 0,0291 | 0,1005 | 3.250 |
|--------|--------|--------|-------|

12 mm - three-legged

| | | | |
|--------|--------|--------|-------|
| 0,0306 | 0,0334 | 0,1209 | 2.650 |
|--------|--------|--------|-------|

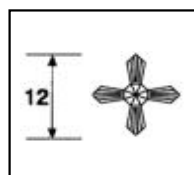
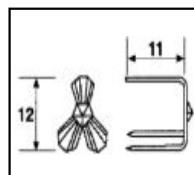

Z.9145 (distributor ... four-legged)

12 mm - four-legged

| | | | |
|--------|--------|--------|-------|
| 0,0429 | 0,0485 | 0,0841 | 2.800 |
|--------|--------|--------|-------|

| COLOR | COLOR plated | COLOR plated | minimum quantity |
|---------------|-----------------|-----------------|---------------------|
| BRASS | CHROME | GOLD | |
| EURO piece | EURO piece | EURO piece | BAG pieces |

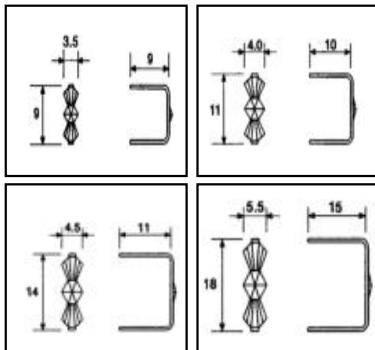

Z.9141 (connector)

| | | | | |
|--------------|--------|--------|-------|--|
| <u>9 mm</u> | | | | |
| 0,0071 | 0,0089 | 0,0446 | 6.490 | |
| <u>11 mm</u> | | | | |
| 0,0085 | 0,0108 | 0,0572 | 5.000 | |
| <u>14 mm</u> | | | | |
| 0,0101 | 0,0132 | 0,0745 | 3.780 | |
| <u>18 mm</u> | | | | |
| 0,0156 | 0,0200 | 0,1075 | 2.650 | |

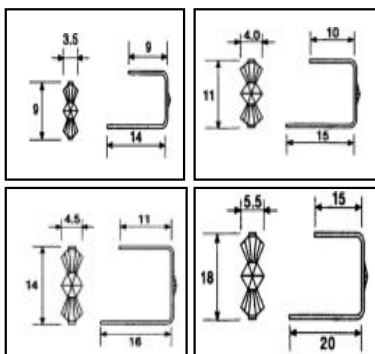

Z.9142 (connector ... asymmetric)

| | | | | |
|---------------------------|--------|--------|-------|--|
| <u>9 mm - asymmetric</u> | | | | |
| 0,0079 | 0,0099 | 0,0489 | 5.940 | |
| <u>11 mm - asymmetric</u> | | | | |
| 0,0094 | 0,0118 | 0,0612 | 4.700 | |
| <u>14 mm - asymmetric</u> | | | | |
| 0,0122 | 0,0155 | 0,0825 | 3.460 | |
| <u>18 mm - asymmetric</u> | | | | |
| 0,0181 | 0,0229 | 0,1187 | 2.420 | |

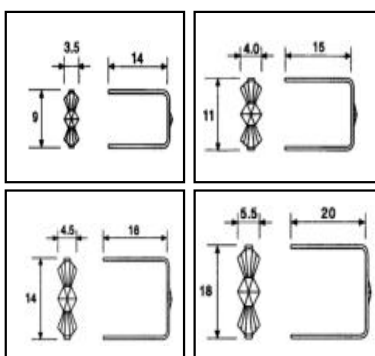

Z.9143 (connector ... long-legged)

| | | | | |
|----------------------------|--------|--------|-------|--|
| <u>9 mm - long-legged</u> | | | | |
| 0,0088 | 0,0109 | 0,0539 | 5.390 | |
| <u>11 mm - long-legged</u> | | | | |
| 0,0107 | 0,0133 | 0,0672 | 4.300 | |
| <u>14 mm - long-legged</u> | | | | |
| 0,0140 | 0,0176 | 0,0907 | 3.170 | |
| <u>18 mm - long-legged</u> | | | | |
| 0,0201 | 0,0251 | 0,1264 | 2.290 | |

| COLOR | COLOR <u>plated</u> | COLOR <u>plated</u> | minimum quantity |
|---------------|------------------------|------------------------|----------------------|
| BRASS | CHROME | GOLD | |
| EURO piece | EURO piece | EURO piece | BAG pieces |

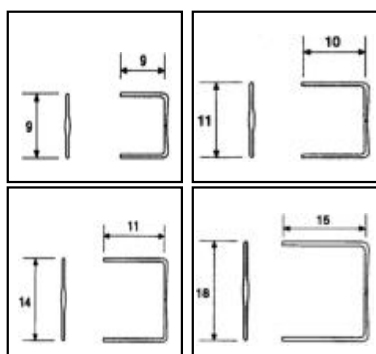

Z.9151 (plain-clip)

| | | | |
|--------------|--------|--------|-------|
| <u>9 mm</u> | | | |
| 0,0039 | 0,0052 | 0,0301 | 9.290 |
| <u>11 mm</u> | | | |
| 0,0041 | 0,0054 | 0,0321 | 8.700 |
| <u>14 mm</u> | | | |
| 0,0057 | 0,0077 | 0,0486 | 5.680 |
| <u>18 mm</u> | | | |
| 0,0071 | 0,0097 | 0,0622 | 4.420 |

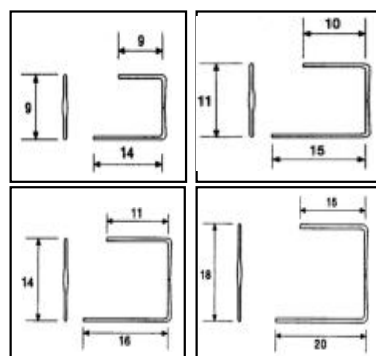

Z.9152 (plain-clip ... asymmetric)

| | | | |
|---------------------------|--------|--------|-------|
| <u>9 mm - asymmetric</u> | | | |
| 0,0041 | 0,0055 | 0,0325 | 8.580 |
| <u>11 mm - asymmetric</u> | | | |
| 0,0047 | 0,0063 | 0,0379 | 7.320 |
| <u>14 mm - asymmetric</u> | | | |
| 0,0065 | 0,0089 | 0,0561 | 4.910 |
| <u>18 mm - asymmetric</u> | | | |
| 0,0078 | 0,0107 | 0,0693 | 3.960 |

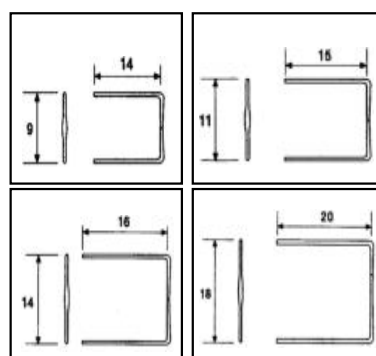

Z.9153 (plain-clip ... long-legged)

| | | | |
|----------------------------|--------|--------|-------|
| <u>9 mm - long-legged</u> | | | |
| 0,0047 | 0,0063 | 0,0384 | 7.230 |
| <u>11 mm - long-legged</u> | | | |
| 0,0053 | 0,0071 | 0,0441 | 6.280 |
| <u>14 mm - long-legged</u> | | | |
| 0,0070 | 0,0096 | 0,0611 | 4.500 |
| <u>18 mm - long-legged</u> | | | |
| 0,0083 | 0,0114 | 0,0741 | 3.700 |

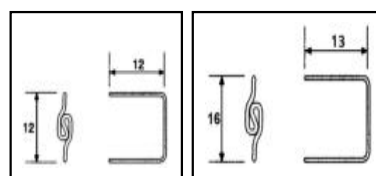

Z.9160 (snake-clip)

| | | | |
|--------------|--------|--------|-------|
| <u>12 mm</u> | | | |
| 0,0081 | 0,0100 | 0,0503 | 5.750 |
| <u>16 mm</u> | | | |
| 0,0098 | 0,0119 | 0,0552 | 5.350 |

| COLOR | COLOR <u>plated</u> | COLOR <u>plated</u> | minimum quantity |
|---------------|------------------------|------------------------|---------------------|
| BRASS | CHROME | GOLD | |
| EURO piece | EURO piece | EURO piece | BAG pieces |



Z.9170 (round-ring)

| | | | | |
|--------------|--------|--------|--------|--------|
| <u>7 mm</u> | 0,0033 | 0,0041 | 0,0229 | 12.330 |
| <u>8 mm</u> | 0,0044 | 0,0055 | 0,0307 | 9.200 |
| <u>9 mm</u> | 0,0048 | 0,0060 | 0,0335 | 8.450 |
| <u>10 mm</u> | 0,0063 | 0,0080 | 0,0442 | 6.400 |
| <u>11 mm</u> | 0,0073 | 0,0091 | 0,0506 | 5.590 |



Z.9175 (oval-ring)

| | | | | |
|--------------|--------|--------|--------|--------|
| <u>8 mm</u> | 0,0043 | 0,0051 | 0,0232 | 12.800 |
| <u>9 mm</u> | 0,0056 | 0,0067 | 0,0315 | 9.350 |
| <u>10 mm</u> | 0,0059 | 0,0072 | 0,0351 | 8.300 |
| <u>11 mm</u> | 0,0105 | 0,0128 | 0,0454 | 5.000 |
| <u>13 mm</u> | 0,0128 | 0,0158 | 0,0557 | 2.500 |



Z.9177 (overlapping-ring)

| | | | | |
|--------------|--------|--------|--------|--------|
| <u>9 mm</u> | --- | 0,0036 | 0,0064 | 10.000 |
| <u>11 mm</u> | 0,0078 | 0,0044 | 0,0078 | 10.000 |
| <u>13 mm</u> | --- | 0,0047 | 0,0175 | 6.790 |
| <u>15 mm</u> | --- | 0,0070 | 0,0461 | 5.600 |
| <u>20 mm</u> | --- | 0,0199 | 0,0821 | 2.000 |

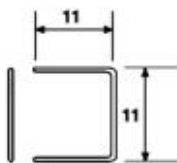

Z.9172 (extrastrong-clip ... stainless-steel)

| | | | | |
|--------------|-----|--------|-----|-------|
| <u>11 mm</u> | --- | 0,0500 | --- | 1.000 |
|--------------|-----|--------|-----|-------|

| COLOR | COLOR <u>plated</u> | COLOR <u>plated</u> | minimum quantity |
|---------------|------------------------|------------------------|---------------------|
| BRASS | CHROME | GOLD | |
| EURO piece | EURO piece | EURO piece | BAG pieces |



Z.9180 (pendant-fixing #1-A)

| | | | |
|----------------|--------|--------|--------|
| <u>13x8 mm</u> | | | |
| --- | 0,0531 | 0,0569 | 0,1227 |
| | | | 1.000 |



Z.9181 (pendant-fixing #1-B)

| | | | |
|-----------------|--------|--------|-------|
| <u>14x8 mm</u> | | | |
| --- | 0,0210 | 0,0369 | 5.900 |
| <u>17x10 mm</u> | | | |
| --- | 0,0262 | 0,0532 | 3.200 |
| <u>18x12 mm</u> | | | |
| --- | 0,0291 | 0,0668 | 2.900 |
| <u>18x14 mm</u> | | | |
| --- | 0,0519 | 0,1331 | 1.000 |
| <u>18x16 mm</u> | | | |
| --- | 0,0558 | 0,1553 | 1.000 |



Z.9182 (pendant-fixing #2-A)

| | | | |
|-----------------|--------|--------|-------|
| <u>8x10 mm</u> | | | |
| --- | 0,0812 | 0,1286 | 1.000 |
| <u>9x11 mm</u> | | | |
| --- | 0,0818 | 0,1414 | 1.000 |
| <u>14x13 mm</u> | | | |
| --- | 0,1479 | 0,2061 | 1.000 |



Z.9183 (pendant-fixing #2-B)

| | | | |
|----------------|--------|--------|-------|
| <u>10x9 mm</u> | | | |
| --- | 0,0238 | 0,0291 | 1.000 |



Z.9185 (pendant-fixing #3)

| | | | |
|----------------|--------|--------|-------|
| <u>11x3 mm</u> | | | |
| --- | 0,1008 | 0,2072 | 1.000 |

| COLOR | COLOR <u>plated</u> | COLOR <u>plated</u> | minimum quantity |
|---------------|------------------------|------------------------|---------------------|
| BRASS | CHROME | GOLD | |
| EURO piece | EURO piece | EURO piece | BAG pieces |



Z.9186 (pendant-fixing #4)

| | | | | |
|--------------|--------|-----|--|-----|
| <u>13 mm</u> | | | | |
| --- | 0,9601 | --- | | 100 |
| <u>14 mm</u> | | | | |
| --- | 1,0547 | --- | | 100 |
| <u>15 mm</u> | | | | |
| --- | 1,1524 | --- | | 100 |
| <u>20 mm</u> | | | | |
| --- | 1,2673 | --- | | 100 |



Z.9189 (pendant-fixing #5)

| | | | | |
|-----------------|--------|--------|--|-------|
| <u>18'16 mm</u> | | | | |
| 0,0175 | 0,0222 | 0,0453 | | 1.000 |



Z.9164 (pendant-fixing #6 ... magnet-mount)

| | | | | |
|-------------------------------|--------|--------|--|---|
| <u>8 mm Ø ... 7mm Height</u> | | | | |
| --- | 2,4318 | 2,4318 | | 2 |
| <u>10 mm Ø ... 9mm Height</u> | | | | |
| --- | 2,5708 | 2,5708 | | 2 |



Z.9187 (snap-hook ... for hanging chains of crystals)

| | | | | |
|--------------|--------|-----|--|-----|
| <u>10 mm</u> | | | | |
| --- | 0,0336 | --- | | 100 |
| <u>12 mm</u> | | | | |
| --- | 0,0577 | --- | | 100 |
| <u>16 mm</u> | | | | |
| --- | 0,1077 | --- | | 100 |



Z.9188 (snap-hook ... for hanging chains of crystals)

| | | | | |
|----------------------|--------|-----|--|-----|
| <u>12x1,2x0,6 mm</u> | | | | |
| --- | 0,0865 | --- | | 100 |
| <u>16x1,2x0,7 mm</u> | | | | |
| --- | 0,1221 | --- | | 100 |
| <u>20x2,0x0,8 mm</u> | | | | |
| --- | 0,2212 | --- | | 100 |
| <u>26x2,0x0,9 mm</u> | | | | |
| --- | 0,3259 | --- | | 100 |
| <u>30x3,0x1,5 mm</u> | | | | |
| --- | 0,5280 | --- | | 100 |

| COLOR | COLOR <u>plated</u> | COLOR <u>plated</u> | minimum quantity |
|---------------|------------------------|------------------------|---------------------|
| BRASS | CHROME | GOLD | |
| EURO piece | EURO piece | EURO piece | BAG pieces |



Z.9190 (traditional-pin 0.8mm ... head-diameter: 2.0mm)

| | | | | |
|---------------|--------|--------|--------|--------|
| <u>10 mm</u> | 0,0022 | 0,0028 | 0,0155 | 18.200 |
| <u>15 mm</u> | 0,0033 | 0,0041 | 0,0230 | 12.300 |
| <u>20 mm</u> | 0,0042 | 0,0053 | 0,0295 | 9.600 |
| <u>25 mm</u> | 0,0050 | 0,0063 | 0,0349 | 8.100 |
| <u>30 mm</u> | 0,0061 | 0,0076 | 0,0422 | 6.700 |
| <u>35 mm</u> | 0,0070 | 0,0088 | 0,0488 | 5.800 |
| <u>40 mm</u> | 0,0077 | 0,0097 | 0,0540 | 5.240 |
| <u>45 mm</u> | 0,0095 | 0,0115 | 0,0608 | 4.700 |
| <u>50 mm</u> | 0,0106 | 0,0128 | 0,0680 | 4.200 |
| <u>60 mm</u> | 0,0131 | 0,0159 | 0,0841 | 3.400 |
| <u>70 mm</u> | 0,0149 | 0,0180 | 0,0953 | 3.000 |
| <u>80 mm</u> | 0,0172 | 0,0207 | 0,1099 | 2.600 |
| <u>90 mm</u> | 0,0194 | 0,0234 | 0,1243 | 2.300 |
| <u>100 mm</u> | 0,0223 | 0,0270 | 0,1429 | 2.000 |



Z.9191 (traditional-pin 0.8mm ... head-diameter: 2.5mm)

| | | | | |
|--------------|--------|--------|--------|-------|
| <u>20 mm</u> | 0,0075 | 0,0087 | 0,0257 | 9.800 |
| <u>25 mm</u> | 0,0074 | 0,0088 | 0,0287 | 8.100 |
| <u>30 mm</u> | 0,0086 | 0,0103 | 0,0337 | 6.900 |
| <u>35 mm</u> | 0,0101 | 0,0120 | 0,0394 | 5.900 |
| <u>40 mm</u> | 0,0119 | 0,0142 | 0,0465 | 5.000 |



Z.9192 (traditional-pin 0.8mm ... head-diameter: 3.0mm)

| | | | | |
|--------------|--------|--------|--------|-------|
| <u>20 mm</u> | 0,0306 | 0,0316 | 0,0429 | 8.000 |
| <u>25 mm</u> | 0,0306 | 0,0359 | 0,0510 | 7.200 |
| <u>30 mm</u> | 0,0315 | 0,0460 | 0,0623 | 5.500 |
| <u>35 mm</u> | 0,0341 | 0,0499 | 0,0676 | 5.070 |
| <u>40 mm</u> | 0,0368 | 0,0539 | 0,0729 | 4.700 |

| COLOR | COLOR <u>plated</u> | COLOR <u>plated</u> | minimum quantity |
|---------------|------------------------|------------------------|---------------------|
| BRASS | CHROME | GOLD | |
| EURO piece | EURO piece | EURO piece | BAG pieces |



Z.9195 (bead-pin 0.8mm)

| | | | | |
|---------------|--------|--------|--------|--------|
| <u>10 mm</u> | 0,0029 | 0,0034 | 0,0179 | 16.000 |
| <u>15 mm</u> | 0,0039 | 0,0046 | 0,0242 | 11.800 |
| <u>20 mm</u> | 0,0047 | 0,0061 | 0,0292 | 9.800 |
| <u>25 mm</u> | 0,0058 | 0,0068 | 0,0362 | 7.900 |
| <u>30 mm</u> | 0,0067 | 0,0078 | 0,0414 | 6.900 |
| <u>35 mm</u> | 0,0075 | 0,0088 | 0,0465 | 6.150 |
| <u>40 mm</u> | 0,0084 | 0,0098 | 0,0520 | 5.500 |
| <u>45 mm</u> | 0,0104 | 0,0122 | 0,0595 | 4.900 |
| <u>50 mm</u> | 0,0119 | 0,0139 | 0,0678 | 4.300 |
| <u>60 mm</u> | 0,0136 | 0,0159 | 0,0778 | 3.750 |
| <u>70 mm</u> | 0,0165 | 0,0193 | 0,0941 | 3.100 |
| <u>80 mm</u> | 0,0186 | 0,0217 | 0,1060 | 2.750 |
| <u>90 mm</u> | 0,0217 | 0,0254 | 0,1241 | 2.350 |
| <u>100 mm</u> | 0,0222 | 0,0260 | 0,1268 | 2.300 |



Z.9166 (MT-arms-pin 1.0mm)

| | | | | |
|-----------------|--------|--------|--------|-------|
| <u>55x20 mm</u> | 0,0369 | 0,0426 | 0,1108 | 2.000 |
|-----------------|--------|--------|--------|-------|



Z.9167 (MT-arms-pin 1.0mm)

| | | | | |
|-----------------|--------|--------|--------|-------|
| <u>55x43 mm</u> | 0,0477 | 0,0550 | 0,1430 | 1.550 |
|-----------------|--------|--------|--------|-------|

| COLOR | COLOR <u>plated</u> | COLOR <u>plated</u> | minimum quantity |
|---------------|------------------------|------------------------|---------------------|
| BRASS | CHROME | GOLD | |
| EURO piece | EURO piece | EURO piece | BAG pieces |

Z.9196 (plastic-thread)

| | | | |
|---------------|------------------|-----|-------|
| <u>0,4 mm</u> | <u>per meter</u> | | |
| --- | 0,1021 | --- | 100 m |
| <u>0,5 mm</u> | <u>per meter</u> | | |
| --- | 0,1164 | --- | 100 m |
| <u>0,7 mm</u> | <u>per meter</u> | | |
| --- | 0,1912 | --- | 100 m |
| <u>0,8 mm</u> | <u>per meter</u> | | |
| --- | 0,2348 | --- | 100 m |
| <u>1,0 mm</u> | <u>per meter</u> | | |
| --- | 0,4073 | --- | 50 m |

Z.9197 (steel-cable)

| | | | |
|---------------|------------------|-----|-------|
| <u>0,3 mm</u> | <u>per meter</u> | | |
| --- | 2,1536 | --- | 200 m |
| <u>0,6 mm</u> | <u>per meter</u> | | |
| --- | 1,3812 | --- | 200 m |
| <u>0,8 mm</u> | <u>per meter</u> | | |
| --- | 1,0476 | --- | 200 m |
| <u>1,0 mm</u> | <u>per meter</u> | | |
| --- | 1,0476 | --- | 200 m |
| <u>1,5 mm</u> | <u>per meter</u> | | |
| --- | 1,2738 | --- | 200 m |
| <u>2,0 mm</u> | <u>per meter</u> | | |
| --- | 1,2738 | --- | 200 m |
| <u>3,0 mm</u> | <u>per meter</u> | | |
| --- | 2,1239 | --- | 200 m |

Z.9199 (wire)

0,4 mm (for small crystals)

| | | | |
|---------------|---------------|-----|---------------|
| <u>60 mm</u> | <u>60mm</u> | | |
| 0,0146 | 0,0144 | --- | 10.000 pieces |
| <u>per kg</u> | <u>per kg</u> | | |
| 81,4323 | 127,3388 | --- | 0,25 kg |

0,6 mm (for medium crystals)

| | | | |
|------------------|------------------|-----|------|
| <u>per meter</u> | <u>per meter</u> | | |
| 0,1962 | 0,1962 | --- | 17 m |

0,8 mm (for large crystals)

| | | | |
|------------------|------------------|-----|-----|
| <u>per meter</u> | <u>per meter</u> | | |
| 0,3706 | 0,3706 | --- | 9 m |

1,0 mm (for extra-large crystals)

| | | | |
|------------------|------------------|-----|-----|
| <u>per meter</u> | <u>per meter</u> | | |
| 0,4538 | 0,4538 | --- | 7 m |

| COLOR | COLOR plated | COLOR plated | minimum quantity |
|---------------|-----------------|-----------------|---------------------|
| BRASS | CHROME | GOLD | |
| EURO piece | EURO piece | EURO piece | BAG pieces |



Z.9198 TYPE I (squeeze-ring ... for plastic-thread or for steel-cable or for wire)

| | | | |
|-----------|---|-----|-------|
| a) 2,0 mm | (for 0,3mm plastic-thread or 0,3mm steel-cable or 0,4mm wire) | | |
| --- | 0,0137 | --- | 1.000 |
| b) 2,8 mm | (for 0,6mm+0,8mm steel-cable or 0,6+0,8mm wire) | | |
| --- | 0,0246 | --- | 1.000 |
| c) 3,0 mm | (for 1,0mm steel-cable or 1,0mm wire) | | |
| --- | 0,0324 | --- | 1.000 |
| d) 3,5 mm | (for 1,5mm steel-cable) | | |
| --- | 0,0596 | --- | 1.000 |



Z.9198 TYPE II (cable-end squeeze-ring ... for steel-cable)

| | | | |
|-------------|-------------------------------|-----|-----|
| a) 0,5+6 mm | (for 0,6mm+0,8mm steel-cable) | | |
| --- | 0,0182 | --- | 100 |
| b) 1,0+8 mm | (for 1,0mm steel-cable) | | |
| --- | 0,0632 | --- | 100 |
| c) 1,5+8 mm | (for 1,5mm steel-cable) | | |
| --- | 0,0632 | --- | 100 |



Z.9198 TYPE III (loop-making squeeze-ring ... for steel-cable)

| | | | |
|--------------|-------------------------------|-----|-----|
| a) 5x5x3 mm | (for 0,6mm+0,8mm steel-cable) | | |
| --- | 0,1319 | --- | 100 |
| b) 6x6x4 mm | (for 1,0mm+1,5mm steel-cable) | | |
| --- | 0,1436 | --- | 100 |
| c) 7x7x4 mm | (for 2,0mm steel-cable) | | |
| --- | 0,1102 | --- | 100 |
| d) 11x9x6 mm | (for 3,0mm steel-cable) | | |
| --- | 0,1467 | --- | 100 |



Z.9198 TYPE IV (screw-mountable splice for two cables ... for steel-cable)

| | | | |
|------------|-------------------------|-----|-----|
| 18x12x6 mm | (for 2,0mm steel-cable) | | |
| --- | 0,9645 | --- | 100 |

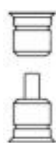

Z.9198 TYPE V (height-adjustable center-ring (two pieces) ... for steel-cable)

consisting of :

Part #A: 16x8+10 mm & Part #B: 10x8+10 mm (for 0,8mm or 1,0mm steel-cable)

| | | | |
|-----|--------|-----|-----|
| --- | 6,3922 | --- | 100 |
|-----|--------|-----|-----|

| COLOR | COLOR <u>plated</u> | COLOR <u>plated</u> | minimum quantity |
|---------------|------------------------|------------------------|---------------------|
| BRASS | CHROME | GOLD | |
| EURO piece | EURO piece | EURO piece | BAG pieces |



Z.9111 (link-chain)

| | | | |
|---------------------|------------------|-----|-------|
| <u>3,5 x 1,0 mm</u> | <u>per meter</u> | | |
| --- | 0,4036 | --- | 100 m |



Z.9112 (link-chain)

| | | | |
|---------------------|------------------|-----|-------|
| <u>4,0 x 1,0 mm</u> | <u>per meter</u> | | |
| --- | 0,4036 | --- | 100 m |



Z.9193 (ball-chain)

| | | | |
|---------------|------------------|------------------|------|
| <u>1,5 mm</u> | <u>per meter</u> | <u>per meter</u> | |
| --- | 0,9262 | 0,9683 | 50 m |
| <u>2,0 mm</u> | <u>per meter</u> | <u>per meter</u> | |
| --- | 1,0946 | 1,1367 | 50 m |
| <u>2,5 mm</u> | <u>per meter</u> | <u>per meter</u> | |
| --- | 2,3577 | 2,3998 | 50 m |
| <u>3,0 mm</u> | <u>per meter</u> | <u>per meter</u> | |
| --- | 2,3577 | 2,3998 | 50 m |
| <u>4,0 mm</u> | <u>per meter</u> | <u>per meter</u> | |
| --- | 2,3577 | 2,3998 | 50 m |
| <u>4,5 mm</u> | <u>per meter</u> | <u>per meter</u> | |
| --- | 3,0313 | 3,0734 | 50 m |



Z.9194 (eyelet-ring ... for ball-chain)

| | | | |
|--|------------------|------------------|-----|
| <u>2,5 mm (for balls-chains 1,5mm & 2,0mm)</u> | <u>per meter</u> | <u>per meter</u> | |
| --- | 0,0958 | 0,0958 | 100 |
| <u>3,0 mm (for balls-chains 2,5mm & 3,0mm)</u> | <u>per meter</u> | <u>per meter</u> | |
| --- | 0,1477 | 0,1477 | 100 |
| <u>4,0 mm (for balls-chains 4,0mm & 4,5mm)</u> | <u>per meter</u> | <u>per meter</u> | |
| --- | 0,1907 | 0,1907 | 100 |
| <u>5,0 mm (for balls-chains 4,0mm & 4,5mm)</u> | <u>per meter</u> | <u>per meter</u> | |
| --- | 0,2754 | 0,2754 | 100 |

| COLOR | COLOR <u>plated</u> | COLOR <u>plated</u> | minimum quantity |
|---------------|------------------------|------------------------|---------------------|
| BRASS | CHROME | GOLD | |
| EURO piece | EURO piece | EURO piece | BAG pieces |

Z.9178 (chain-spacer ... BRASS-tube)

(for plastic-thread & steel-cable & wire)

2,0 mm outside-diameter

1,0 mm inside-diameter

5 x 2,0 mm

| | | | |
|-----|--------|-----|--------|
| --- | 0,0098 | --- | 10.900 |
|-----|--------|-----|--------|

10 x 2,0 mm

| | | | |
|-----|--------|-----|-------|
| --- | 0,0196 | --- | 5.430 |
|-----|--------|-----|-------|

15 x 2,0 mm

| | | | |
|-----|--------|-----|-------|
| --- | 0,0287 | --- | 3.700 |
|-----|--------|-----|-------|

20 x 2,0 mm

| | | | |
|-----|--------|-----|-------|
| --- | 0,0369 | --- | 2.880 |
|-----|--------|-----|-------|

25 x 2,0 mm

| | | | |
|-----|--------|-----|-------|
| --- | 0,0451 | --- | 2.360 |
|-----|--------|-----|-------|

30 x 2,0 mm

| | | | |
|-----|--------|-----|-------|
| --- | 0,0567 | --- | 1.875 |
|-----|--------|-----|-------|

Z.9179 (chain-spacer ... PUR-PLASTIC-tube, flexible, transparent)

(for plastic-thread & steel-cable & wire)

UV-resistant (suitable for inside/outside applications)

4,0 mm outside-diameter

2,0 mm inside-diameter

| | | | |
|-----|----------------------------|-----|-------|
| --- | <u>per meter</u> 1,3621 | --- | 100 m |
|-----|----------------------------|-----|-------|

| COLOR | COLOR <u>plated</u> | COLOR <u>plated</u> |
|---------------|------------------------|------------------------|
| BRASS | CHROME | GOLD |
| EURO piece | EURO piece | EURO piece |

PINNING SERVICE

pinning material
+
pinning work

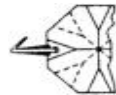

HANGER_INSERTION

| | | | |
|--------------|--------|--------|--|
| <u>12 mm</u> | | | |
| 0,0606 | 0,0628 | 0,1064 | |
| <u>15 mm</u> | | | |
| 0,0660 | 0,0692 | 0,1354 | |
| <u>19 mm</u> | | | |
| 0,0798 | 0,0846 | 0,1836 | |

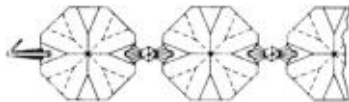

CONNECTOR_PINNING

| | | | |
|-----------------------------|--------|--------|--|
| <u>9 mm</u> | | | |
| 0,0679 | 0,0699 | 0,1107 | |
| <u>11 mm</u> | | | |
| 0,0695 | 0,0721 | 0,1251 | |
| <u>14 mm</u> | | | |
| 0,0713 | 0,0747 | 0,1449 | |
| <u>18 mm</u> | | | |
| 0,0775 | 0,0825 | 0,1825 | |
| <u>9 mm - asymmetric</u> | | | |
| 0,0687 | 0,0709 | 0,1155 | |
| <u>11 mm - asymmetric</u> | | | |
| 0,0705 | 0,0733 | 0,1297 | |
| <u>14 mm - asymmetric</u> | | | |
| 0,0737 | 0,0775 | 0,1541 | |
| <u>18 mm - asymmetric</u> | | | |
| 0,0805 | 0,0859 | 0,1953 | |
| <u>9 mm - long-legged</u> | | | |
| 0,0759 | 0,0783 | 0,1275 | |
| <u>11 mm - long-legged</u> | | | |
| 0,0781 | 0,0811 | 0,1427 | |
| <u>14 mm - long-legged</u> | | | |
| 0,0819 | 0,0859 | 0,1695 | |
| <u>18 mm - long-legged</u> | | | |
| 0,0889 | 0,0945 | 0,2103 | |
| <u>10 mm - three-legged</u> | | | |
| 0,1149 | 0,1171 | 0,1987 | |
| <u>12 mm - three-legged</u> | | | |
| 0,1189 | 0,1221 | 0,2221 | |
| <u>12 mm - four-legged</u> | | | |
| 0,1869 | 0,1933 | 0,2341 | |

| COLOR | COLOR plated | COLOR plated |
|---------------|-----------------|-----------------|
| BRASS | CHROME | GOLD |
| EURO piece | EURO piece | EURO piece |

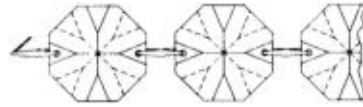

PLAIN-CLIP_PINNING

| | | | |
|--------------|--------|--------|--------|
| <u>9 mm</u> | 0,0803 | 0,0817 | 0,1103 |
| <u>11 mm</u> | 0,0805 | 0,0821 | 0,1125 |
| <u>14 mm</u> | 0,0825 | 0,0847 | 0,1315 |
| <u>18 mm</u> | 0,0841 | 0,0871 | 0,1469 |

| | | | |
|-------------------------|--------|--------|--------|
| <u>9 mm - asyetric</u> | 0,0807 | 0,0821 | 0,1131 |
| <u>11 mm - asyetric</u> | 0,0813 | 0,0831 | 0,1193 |
| <u>14 mm - asyetric</u> | 0,0833 | 0,0861 | 0,1399 |
| <u>18 mm - asyetric</u> | 0,0849 | 0,0881 | 0,1551 |

| | | | |
|----------------------------|--------|--------|--------|
| <u>9 mm - long-legged</u> | 0,0889 | 0,0907 | 0,1273 |
| <u>11 mm - long-legged</u> | 0,0895 | 0,0917 | 0,1339 |
| <u>14 mm - long-legged</u> | 0,0915 | 0,0945 | 0,1533 |
| <u>18 mm - long-legged</u> | 0,0929 | 0,0965 | 0,1681 |

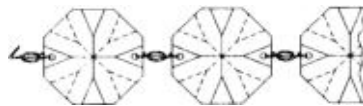

SNAKE-CLIP_PINNING

| | | | |
|--------------|--------|--------|--------|
| <u>12 mm</u> | 0,0951 | 0,0973 | 0,1435 |
| <u>16 mm</u> | 0,0971 | 0,0995 | 0,1491 |

| COLOR | COLOR plated | COLOR plated |
|---------------|-----------------|-----------------|
| BRASS | CHROME | GOLD |
| EURO piece | EURO piece | EURO piece |

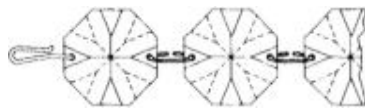

ROUND-RING_PINNING

| | | | |
|--------------|--------|--------|--------|
| <u>7 mm</u> | 0,0735 | 0,0745 | 0,0959 |
| <u>8 mm</u> | 0,0747 | 0,0761 | 0,1049 |
| <u>9 mm</u> | 0,0751 | 0,0767 | 0,1079 |
| <u>10 mm</u> | 0,0769 | 0,0789 | 0,1203 |
| <u>11 mm</u> | 0,0779 | 0,0801 | 0,1275 |

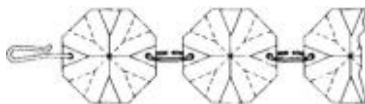

OVAL-RING_PINNING

| | | | |
|--------------|--------|--------|--------|
| <u>8 mm</u> | 0,0747 | 0,0755 | 0,0963 |
| <u>9 mm</u> | 0,0761 | 0,0773 | 0,1057 |
| <u>10 mm</u> | 0,0765 | 0,0779 | 0,1099 |
| <u>11 mm</u> | 0,0817 | 0,0843 | 0,1151 |
| <u>13 mm</u> | 0,0843 | 0,0877 | 0,1253 |

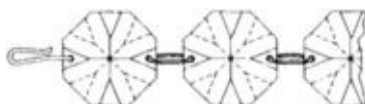

OVERLAPPING-RING_PINNING

| | | | |
|--------------|--------|--------|--------|
| <u>9 mm</u> | --- | 0,1126 | 0,1157 |
| <u>11 mm</u> | 0,1172 | 0,1172 | 0,1172 |
| <u>13 mm</u> | --- | 0,1409 | 0,1555 |
| <u>15 mm</u> | --- | 0,1774 | 0,2222 |
| <u>20 mm</u> | --- | 0,2343 | 0,3055 |

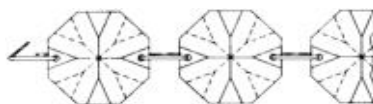

WIRE-CLIP-S.S._PINNING

| | | | |
|--------------|-----|--------|-----|
| <u>11 mm</u> | --- | 1,1825 | --- |
|--------------|-----|--------|-----|

| COLOR | COLOR plated | COLOR plated |
|---------------|-----------------|-----------------|
| BRASS | CHROME | GOLD |
| EURO piece | EURO piece | EURO piece |

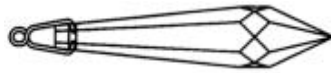

PENDANT-FIXING-#1-A_INSERTION

| | | | |
|--------------|--------|--------|--------|
| <u>13 mm</u> | 0,1311 | 0,1328 | 0,1902 |
|--------------|--------|--------|--------|

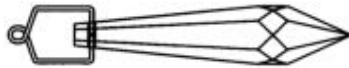

PENDANT-FIXING-#1-B_INSERTION

| | | | |
|-----------------|-----|--------|--------|
| <u>14x8 mm</u> | --- | 0,0837 | 0,1019 |
| <u>17x10 mm</u> | --- | 0,0897 | 0,1205 |
| <u>18x12 mm</u> | --- | 0,0929 | 0,1361 |
| <u>18x14 mm</u> | --- | 0,1189 | 0,2117 |
| <u>18x16 mm</u> | --- | 0,1235 | 0,2373 |

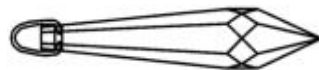

PENDANT-FIXING-#2-A_INSERTION

| | | | |
|-----------------|-----|--------|--------|
| <u>8x10 mm</u> | --- | 0,1787 | 0,2329 |
| <u>9x11 mm</u> | --- | 0,1795 | 0,2475 |
| <u>14x13 mm</u> | --- | 0,2549 | 0,3215 |



PENDANT-FIXING-#2-B_INSERTION

| | | | |
|----------------|-----|--------|--------|
| <u>10x9 mm</u> | --- | 0,1131 | 0,1191 |
|----------------|-----|--------|--------|

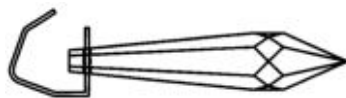

PENDANT-FIXING-#3_INSERTION

| | | | |
|--------------|-----|--------|--------|
| <u>11 mm</u> | --- | 0,1897 | 0,3271 |
|--------------|-----|--------|--------|



PENDANT-FIXING-#4_INSERTION

| | | | |
|--------------|-----|--------|-----|
| <u>13 mm</u> | --- | 1,1831 | --- |
| <u>14 mm</u> | --- | 1,3033 | --- |
| <u>15 mm</u> | --- | 1,4029 | --- |
| <u>20 mm</u> | --- | 1,5343 | --- |

| COLOR | COLOR | COLOR |
|---------------|------------------|----------------|
| BRASS | plated CHROME | plated GOLD |
| EURO piece | EURO piece | EURO piece |

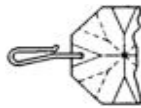

HOOK_INSERTION

| | | | |
|-------|--------|--------|--------|
| 10 mm | 0,0616 | 0,0622 | 0,0768 |
| 15 mm | 0,0628 | 0,0638 | 0,0852 |
| 20 mm | 0,0638 | 0,0650 | 0,0926 |
| 25 mm | 0,0648 | 0,0662 | 0,0990 |
| 30 mm | 0,0660 | 0,0678 | 0,1072 |
| 35 mm | 0,0670 | 0,0690 | 0,1148 |
| 40 mm | 0,0678 | 0,0702 | 0,1206 |
| 45 mm | 0,0698 | 0,0722 | 0,1284 |
| 50 mm | 0,0712 | 0,0736 | 0,1368 |

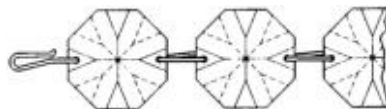

SWAN_PINNING

| | | | |
|-------|--------|--------|--------|
| 10 mm | 0,0620 | 0,0626 | 0,0772 |
| 15 mm | 0,0632 | 0,0642 | 0,0856 |
| 20 mm | 0,0642 | 0,0654 | 0,0930 |
| 25 mm | 0,0652 | 0,0666 | 0,0994 |
| 30 mm | 0,0664 | 0,0682 | 0,1076 |
| 35 mm | 0,0674 | 0,0694 | 0,1152 |
| 40 mm | 0,0682 | 0,0706 | 0,1210 |
| 45 mm | 0,0702 | 0,0726 | 0,1288 |
| 50 mm | 0,0716 | 0,0740 | 0,1372 |

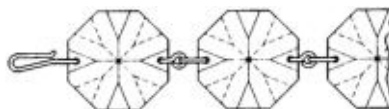

TRADITIONAL_PINNING

| | | | |
|-------|--------|--------|--------|
| 10 mm | 0,1971 | 0,1983 | 0,2275 |
| 15 mm | 0,1995 | 0,2015 | 0,2443 |
| 20 mm | 0,2015 | 0,2039 | 0,2591 |
| 25 mm | 0,2035 | 0,2063 | 0,2719 |
| 30 mm | 0,2059 | 0,2095 | 0,2883 |
| 35 mm | 0,2079 | 0,2119 | 0,3035 |
| 40 mm | 0,2095 | 0,2143 | 0,3151 |
| 45 mm | 0,2135 | 0,2183 | 0,3307 |
| 50 mm | 0,2163 | 0,2211 | 0,3475 |

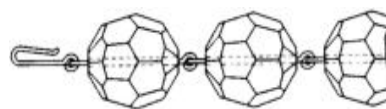

BEAD_PINNING

| | | | |
|-------|--------|--------|--------|
| 10 mm | 0,1399 | 0,1405 | 0,1571 |
| 15 mm | 0,1411 | 0,1419 | 0,1643 |
| 20 mm | 0,1421 | 0,1437 | 0,1701 |
| 25 mm | 0,1433 | 0,1445 | 0,1781 |
| 30 mm | 0,1443 | 0,1457 | 0,1841 |
| 35 mm | 0,1453 | 0,1467 | 0,1899 |
| 40 mm | 0,1463 | 0,1479 | 0,1961 |
| 45 mm | 0,1485 | 0,1507 | 0,2047 |
| 50 mm | 0,1503 | 0,1525 | 0,2141 |

| COLOR | COLOR plated | COLOR plated |
|---------------|-----------------|-----------------|
| BRASS | CHROME | GOLD |
| EURO piece | EURO piece | EURO piece |

examples :

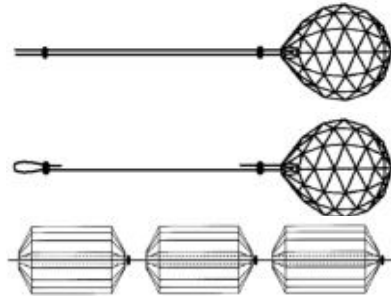

SQUEEZE-RING_PINNING

(without ... plastic-thread or steel-cable or wire !)

| | | |
|--|--------|-----|
| <u>TYPE I a) : 2,0 mm squeeze-ring</u> | | |
| --- | 0,1030 | --- |
| <u>TYPE I b) : 2,8 mm squeeze-ring</u> | | |
| --- | 0,1171 | --- |
| <u>TYPE I c) : 3,0 mm squeeze-ring</u> | | |
| --- | 0,1354 | --- |
| <u>TYPE I d) : 3,5 mm squeeze-ring</u> | | |
| --- | 0,1799 | --- |
| <u>TYPE II a) : for 0,6+0,8mm ... steel-cable</u> | | |
| --- | 0,1209 | --- |
| <u>TYPE II b) : for 1,0mm ... steel-cable</u> | | |
| --- | 0,1481 | --- |
| <u>TYPE II c) : for 1,5mm ... steel-cable</u> | | |
| --- | 0,1481 | --- |
| <u>TYPE III a) : for 0,6+0,8mm ... steel-cable</u> | | |
| --- | 0,3786 | --- |
| <u>TYPE III b) : for 1,0+1,5mm ... steel-cable</u> | | |
| --- | 0,3918 | --- |
| <u>TYPE III c) : for 2,0mm ... steel-cable</u> | | |
| --- | 0,8094 | --- |
| <u>TYPE III d) : for 3,0mm ... steel-cable</u> | | |
| --- | 1,3067 | --- |
| <u>TYPE IV : for 2,0mm ... steel-cable</u> | | |
| --- | 2,6965 | --- |
| <u>TYPE V : for 0,8+1,0mm ... steel-cable</u> | | |
| --- | 7,4541 | --- |



STRUNG_PINNING

(without ... plastic-thread or steel-cable or wire !)

| | | |
|----------------------------------|--------|-----|
| <u>large beads (>= 30mm)</u> | | |
| 0,0743 | 0,0743 | --- |
| <u>medium beads (>= 20mm)</u> | | |
| 0,0743 | 0,0743 | --- |
| <u>small beads (>= 10mm)</u> | | |
| 0,0743 | 0,0743 | --- |
| <u>mini beads (>= 5mm)</u> | | |
| 0,0929 | 0,0929 | --- |
| <u>micro beads (>= 2mm)</u> | | |
| 0,1115 | 0,1115 | --- |

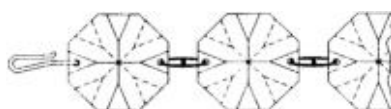

SWEDISH-TWIST_PINNING

| | | |
|------------------------|--------|-----|
| <u>with 0.4mm wire</u> | | |
| 0,2664 | 0,2664 | --- |
| <u>with 0.6mm wire</u> | | |
| 0,4083 | 0,4083 | --- |
| <u>with 0.8mm wire</u> | | |
| 0,4851 | 0,4851 | --- |
| <u>with 1.0mm wire</u> | | |
| 0,5462 | 0,5462 | --- |

SPECIAL PINNING SERVICE

SET PACKING :

plus 3% surcharge on merchandise-value

SINGLE PACKING :

plus 5% surcharge on merchandise-value

GRADUATED CHAINS :

plus 25% surcharge on pinning-service-prices

PARALLEL-PINNING MODERNCUT-OCTAGONS :

plus 20% surcharge on pinning-service-prices

LARGE PINNING-ORDERS :

special pinning-prices for large pinning-orders: on request

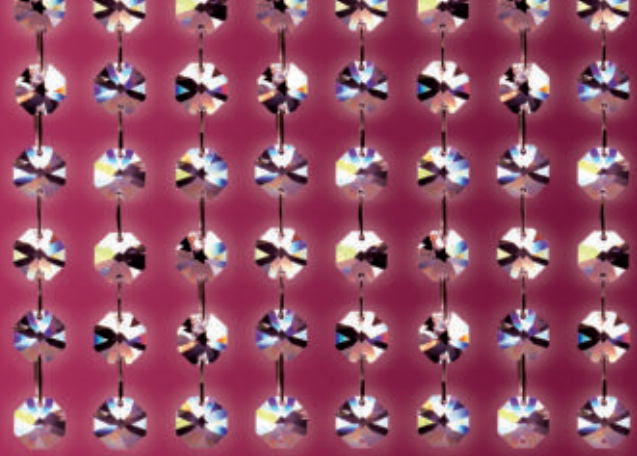

INTERIOR



INTERIOR

fine crystal

premium quality

creative sparkling designs

customized interior solutions

gift-box-packing available

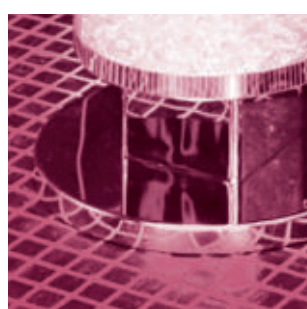
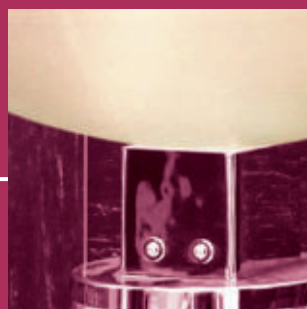

Schöler & Co. GmbH

Gablonzer Strasse 54-61

A-4550 Kremsmünster

Austria

T: ++43-75 83-77 23

F: ++43-75 83-78 12

E: office@scholer-crystal.at

W: www.scholer-crystal.at









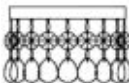

ARTICLE INDEX

| Article: | Page: | Article: | Page: |
|-----------------|--------------|-----------------|--------------|
| I.0101 | 13 | I.7100 | 7 |
| I.0505 | 13 | I.7110 | 7 |
| I.0602 | 12 | I.7120 | 7 |
| I.0603 | 12 | I.7130 | 7 |
| I.0605 | 13 | I.7240 | 11 |
| I.0606 | 13 | I.7244 | 11 |
| I.0608 | 13 | I.7301 | 7 |
| I.0609 | 13 | I.7302 | 7 |
| I.0624 | 10 | I.7312 | 7 |
| I.0625 | 10 | I.7322 | 7 |
| I.0626 | 10 | I.7340 | 7 |
| I.0630 | 18 | I.9701 | 16+17 |
| I.0631 | 12 | I.9702 | 16+17 |
| I.0632 | 12 | I.9709 | 17 |
| I.0634 | 12 | I.9711 | 14 |
| I.0635 | 12 | I.9712 | 14 |
| I.0636 | 13 | I.9713 | 14 |
| I.0637 | 13 | I.9714 | 14 |
| I.0640 | 19 | I.9741 | 20 |
| I.0642 | 12 | I.9771 | 21 |
| I.0643 | 19 | I.9910 | 15 |
| I.0644 | 10 | I.9920 | 15 |
| I.0645 | 12 | I.9930 | 15 |
| I.0646 | 10 | I.9940 | 15 |
| I.0647 | 19 | I.9950 | 15 |
| I.0648 | 19 | | |
| I.0649 | 19 | | |
| I.0668 | 12 | | |
| I.0674 | 10 | | |
| I.0684 | 12 | | |
| I.0688 | 12 | | |
| I.0699 | 13 | | |
| I.0700 | 8+9 | | |
| I.0708 | 8+9 | | |
| I.0720 | 8+9 | | |
| I.0730 | 8+9 | | |
| I.0762 | 10 | | |
| I.0765 | 12 | | |
| I.0792 | 10 | | |
| I.4700 | 11 | | |
| I.4711 | 11 | | |
| I.4715 | 11 | | |
| I.6870 | 13 | | |
| I.6873 | 13 | | |
| I.6883 | 13 | | |
| I.6911 | 13 | | |

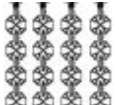
PRODUCT GROUP

Page:

| | | |
|--------------------------------------|---|---------|
| CRYSTAL HANDLES |  | 7 |
| CRYSTAL TILES & FLARES |  | 8 - 9 |
| CRYSTAL ACCENTS |  | 10 - 13 |
| CRYSTAL DOWNLIGHT ORNAMENTATIONS |  | 14 |
| CRYSTAL LED-DOWNLIGHT ORNAMENTATIONS |  | 15 |
| CRYSTAL CURTAINS |  | 16 - 17 |
| CRYSTAL MIRRORS |  | 18 |
| CRYSTAL FACETED STONES |  | 19 |
| CRYSTAL in KILOGRAM |  | 20 |
| ROCKCRYSTAL in KILOGRAM |  | 21 |

| CRYSTAL | CRYSTAL | C O L O R | minimum | |
|---------|---------|-----------|----------|--------|
| CLEAR | coated | JET | quantity | |
| EURO | FOILED | EURO | BOX | CARTON |
| piece | EURO | piece | pieces | pieces |
| | piece | | | |

CRYSTAL HANDLES

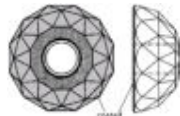

Center Hole : 13mm

I.7130 - 1/2-BALL

| | | | | |
|----------|--------|---------|----|-----|
| 50x20 mm | 6,6026 | 16,0002 | 36 | 432 |
|----------|--------|---------|----|-----|

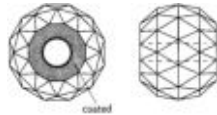

Center Hole : 13mm

I.7312 - BALL

| | | | | |
|----------|--------|---------|----|-----|
| 50x40 mm | 9,9038 | 19,3014 | 12 | 144 |
|----------|--------|---------|----|-----|

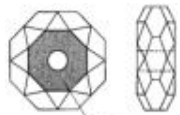

Center Hole : 13mm

I.7322 - RING

| | | | | |
|----------|--------|---------|----|-----|
| 50x20 mm | 6,9913 | 16,3889 | 36 | 432 |
|----------|--------|---------|----|-----|

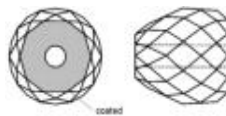

Center Hole : 13mm

I.7340 - RADIANCE

| | | | | |
|----------|--------|---------|----|-----|
| 40x40 mm | 9,9038 | 19,3014 | 12 | 144 |
|----------|--------|---------|----|-----|

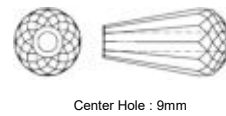

Center Hole : 9mm

I.7301 - CLASSIC

| | | | | |
|-------------|---------|---------|----|-----|
| 56x30/15 mm | 10,5366 | 14,2230 | 30 | 360 |
|-------------|---------|---------|----|-----|

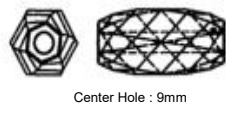

Center Hole : 9mm

I.7302 - SPIRAL

| | | | | |
|-------------|---------|---------|----|-----|
| 56x29/17 mm | 10,6191 | 14,3331 | 30 | 360 |
|-------------|---------|---------|----|-----|

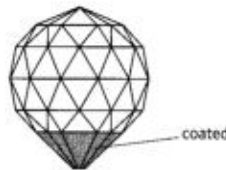

I.7100 - BALL

| | | | | |
|-------|--|---------|-----|-------|
| 20 mm | | 3,0000 | 120 | 1.440 |
| 30 mm | | 4,0000 | 72 | 864 |
| 40 mm | | 5,0000 | 34 | 408 |
| 50 mm | | 10,0000 | 12 | 144 |
| 60 mm | | 15,0000 | 10 | 120 |

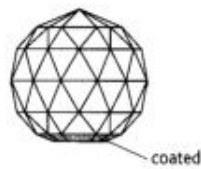

I.7110 - 3/4-BALL

| | | | | |
|-------|--|---------|-----|-------|
| 20 mm | | 4,5000 | 120 | 1.440 |
| 30 mm | | 5,5000 | 72 | 864 |
| 40 mm | | 6,5000 | 34 | 408 |
| 50 mm | | 12,5000 | 12 | 144 |
| 60 mm | | 17,5000 | 10 | 120 |



I.7120 - 1/2-BALL

| | | | | |
|-------|--|---------|-----|-------|
| 20 mm | | 4,5000 | 120 | 1.440 |
| 30 mm | | 5,5000 | 72 | 864 |
| 40 mm | | 6,5000 | 34 | 408 |
| 50 mm | | 12,5000 | 12 | 144 |
| 60 mm | | 17,5000 | 10 | 120 |

CRYSTAL TILES & FLARES

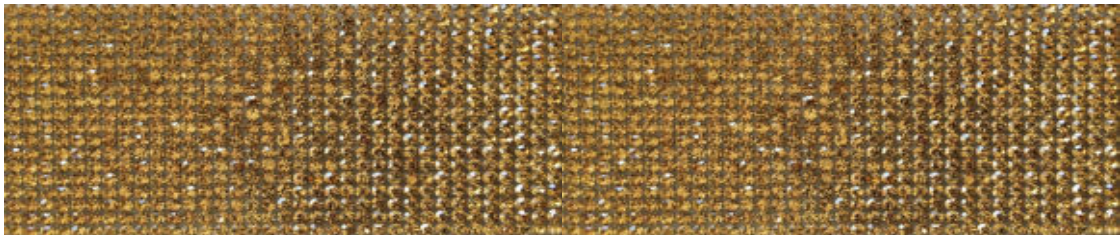
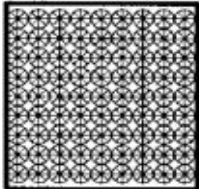
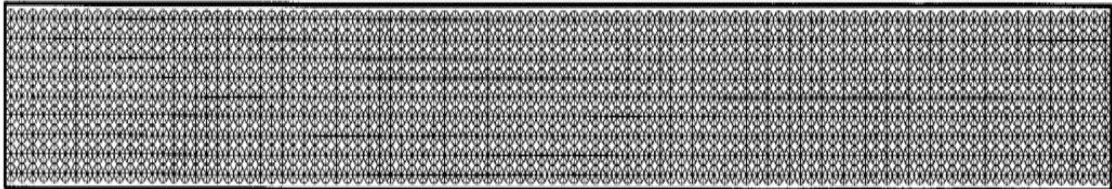

| EURO piece | minimum quantity | | | |
|---------------|---------------------|---------------|------------------|--|
| | PACK pieces | BOX pieces | CARTON pieces | |

I.0700 - TILE - ASFOUR

thickness: 11 mm

| | | | | |
|-------------------------|---------|---|---|-----|
| 300x14 mm CRYSTAL CLEAR | 16,6455 | 1 | 6 | 144 |
| 300x28 mm CRYSTAL CLEAR | 24,4750 | 1 | 3 | 72 |
| 400x14 mm CRYSTAL CLEAR | 20,5602 | 1 | 6 | 96 |
| 400x28 mm CRYSTAL CLEAR | 38,1924 | 1 | 3 | 48 |
| 600x28 mm CRYSTAL CLEAR | 50,9232 | 1 | 6 | 48 |
| 600x50 mm CRYSTAL CLEAR | 76,3848 | 1 | 3 | 24 |
| 600x70 mm CRYSTAL CLEAR | 95,4810 | 1 | 3 | 24 |

I.0708 - TILE - ASFOUR

thickness: 11 mm

| | | | | |
|--------------------------|----------|---|-----|-----|
| 28x28 mm CRYSTAL CLEAR | 2,4507 | 1 | 180 | 540 |
| 50x50 mm CRYSTAL CLEAR | 10,1846 | 1 | 24 | 288 |
| 70x70 mm CRYSTAL CLEAR | 12,7308 | 1 | 6 | 96 |
| 100x100 mm CRYSTAL CLEAR | 31,8270 | 1 | 6 | 54 |
| 200x200 mm CRYSTAL CLEAR | 95,4810 | 1 | 8 | 8 |
| 300x300 mm CRYSTAL CLEAR | 213,9729 | 1 | 4 | 4 |

* for glueing use silicon for mirrors !

+ other designs & colors: on request !

I.0720 - FLARE - ASFOUR

self-adhesive ... thickness: 3 mm

NORMAL chatons

| | | | |
|--------------------------|---------|---|----|
| 600x25 mm CRYSTAL SILVER | 19,4979 | 1 | 24 |
| 600x25 mm CRYSTAL GOLD | 19,4979 | 1 | 24 |
| 600x50 mm CRYSTAL SILVER | 37,5435 | 1 | 12 |
| 600x50 mm CRYSTAL GOLD | 37,5435 | 1 | 12 |

I.0730 - FLARE - ASFOUR

self-adhesive ... thickness: 3 mm

SMALL chatons

| | | | |
|--------------------------|---------|---|----|
| 600x25 mm CRYSTAL SILVER | 23,1750 | 1 | 24 |
| 600x25 mm CRYSTAL GOLD | 23,1750 | 1 | 24 |
| 600x50 mm CRYSTAL SILVER | 46,3500 | 1 | 12 |
| 600x50 mm CRYSTAL GOLD | 46,3500 | 1 | 12 |

| CRYSTAL | minimum quantity | | |
|------------|------------------|------------|------------|
| FOILED | | | |
| EURO piece | PACK pieces | PACK gross | BOX pieces |

CRYSTAL ACCENTS (to glue)

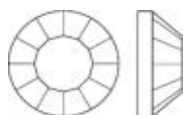

I.0762 - FLAT BACK - to glue - ASFOUR

| | | | | |
|------------------------------|--------|-------|------|---------|
| 1.9 - 2.0 mm (SS06 - PP13) | 0,0078 | 1.440 | (10) | 180.000 |
| 2.3 - 2.4 mm (SS08 - PP17) | 0,0078 | 1.440 | (10) | 158.400 |
| 2.7 - 2.8 mm (SS10 - PP21) | 0,0078 | 1.440 | (10) | 129.600 |
| 3.0 - 3.2 mm (SS12 - PP24) | 0,0091 | 1.440 | (10) | 93.600 |
| 3.8 - 4.0 mm (SS16 - PP31) | 0,0137 | 1.440 | (10) | 72.000 |
| 4.6 - 4.8 mm (SS20) | 0,0194 | 1.440 | (10) | 57.600 |
| 6.4 - 6.6 mm (SS30) | 0,0376 | 288 | (2) | 14.400 |
| 7.2 - 7.4 mm (SS34) | 0,0469 | 288 | (2) | 12.960 |
| 8.4 - 8.7 mm (SS40) | 0,0845 | 144 | (1) | 6.480 |



I.0646 - FLAT BACK - to glue - ASFOUR

| | | | | |
|-------|--------|----|--|-------|
| 10 mm | 0,3455 | 72 | | 1.224 |
| 12 mm | 0,3887 | 72 | | 1.224 |
| 14 mm | 0,4146 | 72 | | 1.224 |
| 18 mm | 0,5528 | 72 | | 864 |

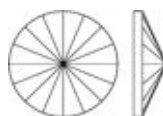

I.0625 - FLAT BACK - to glue - ASFOUR

| | | | | |
|-------|--------|----|--|-------|
| 10 mm | 0,1175 | 72 | | 1.224 |
| 12 mm | 0,1497 | 72 | | 1.224 |
| 14 mm | 0,1820 | 72 | | 1.224 |
| 18 mm | 0,2764 | 72 | | 1.224 |

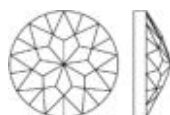

I.0626 - FLAT BACK - to glue - ASFOUR

| | | | | |
|-------|--------|----|--|-------|
| 14 mm | 0,4146 | 72 | | 1.224 |
|-------|--------|----|--|-------|

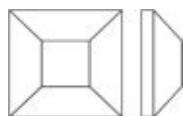

I.0792 - FLAT BACK - to glue - ASFOUR

| | | | | |
|------|--------|-------|------|--------|
| 4 mm | 0,0340 | 1.440 | (10) | 50.400 |
| 8 mm | 0,0507 | 288 | (2) | 4.896 |

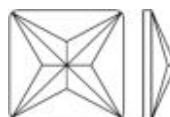

I.0624 - FLAT BACK - to glue - ASFOUR

| | | | | |
|-------|--------|----|--|-------|
| 12 mm | 0,2418 | 72 | | 1.224 |
| 14 mm | 0,3109 | 72 | | 1.224 |

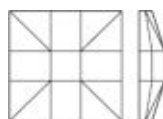

I.0674 - FLAT BACK - to glue - ASFOUR

| | | | | |
|-------|--------|----|--|-----|
| 26 mm | 1,3704 | 16 | | 336 |
|-------|--------|----|--|-----|



I.0644 - FLAT BACK - to glue - ASFOUR

| | | | | |
|-------|--------|-----|-----|-------|
| 8 mm | 0,2533 | 288 | (2) | 2.448 |
| 14 mm | 0,4606 | 72 | | 1.224 |

| CRYSTAL | minimum quantity | | |
|------------|------------------|--|------------|
| FOILED | | | |
| EURO piece | PACK pieces | | BOX pieces |

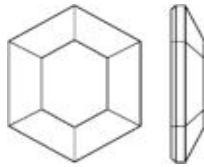

I.4711 - FLAT BACK - to glue - SCHOLER

38x28 mm | 2,4688 | 20 | 80

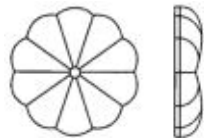

I.4700 - FLAT BACK - to glue - SCHOLER

| | | | |
|-------|---------|----|-----|
| 20 mm | 0,7317 | 48 | 384 |
| 25 mm | 1,0454 | 27 | 270 |
| 30 mm | 1,3966 | 27 | 216 |
| 35 mm | 1,6514 | 20 | 140 |
| 40 mm | 2,1037 | 20 | 140 |
| 50 mm | 3,1900 | 10 | 70 |
| 60 mm | 4,6534 | 6 | 36 |
| 70 mm | 8,9304 | 5 | 25 |
| 80 mm | 13,7750 | 4 | 16 |



I.4715 - FLAT BACK - to glue - SCHOLER

| | | | |
|-------|---------|----|-----|
| 20 mm | 0,7317 | 48 | 384 |
| 25 mm | 1,0454 | 27 | 270 |
| 30 mm | 1,3966 | 27 | 216 |
| 35 mm | 1,6514 | 20 | 140 |
| 40 mm | 2,1037 | 20 | 140 |
| 50 mm | 3,1900 | 10 | 70 |
| 60 mm | 4,6534 | 6 | 36 |
| 70 mm | 8,9304 | 5 | 25 |
| 80 mm | 13,7750 | 4 | 16 |



I.7240 - ONE-COMPONENT CRYSTAL GLUE

1-C GLUE (30 ml) | | | 3,0683 | 1 | 12



I.7244 - ONE-COMPONENT CRYSTAL GLUE ... for crystals up to Ø5mm

1-C GLUE (20 ml) | | | 3,0683 | 1 | 12

| CRYSTAL | minimum quantity | | |
|------------|------------------|------------|------------|
| FOILED | | | |
| EURO piece | PACK pieces | PACK gross | BOX pieces |

CRYSTAL ACCENTS (to fix)



I.0765 - FLAT BACK - to fix - ASFOUR

| | | | | |
|------|--------|-------|------|---------|
| 3 mm | 0,0168 | 1.440 | (10) | 129.600 |
| 4 mm | 0,0198 | 1.440 | (10) | 93.600 |
| 5 mm | 0,0271 | 1.440 | (10) | 64.800 |
| 6 mm | 0,0292 | 720 | (5) | 32.400 |
| 8 mm | 0,0835 | 288 | (2) | 11.520 |



I.0668 - FLAT BACK - to fix - ASFOUR

| | | | | |
|-------|--------|----|--|-------|
| 10 mm | 0,2989 | 72 | | 1.224 |
| 12 mm | 0,3367 | 72 | | 1.224 |

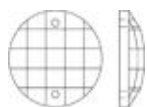

I.0645 - FLAT BACK - to fix - ASFOUR

| | | | | |
|-------|--------|----|--|-------|
| 10 mm | 0,3455 | 72 | | 1.224 |
| 12 mm | 0,3887 | 72 | | 1.224 |
| 14 mm | 0,4146 | 72 | | 1.224 |

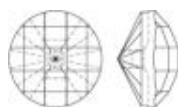

I.0688 - FLAT BACK - to fix - ASFOUR

| | | | | |
|-------|--------|----|--|-------|
| 14 mm | 0,3800 | 72 | | 1.008 |
| 25 mm | 1,2783 | 30 | | 390 |



I.0635 - FLAT BACK - to fix - ASFOUR

| | | | | |
|-------|--------|----|--|-------|
| 10 mm | 0,1410 | 72 | | 1.224 |
| 12 mm | 0,1714 | 72 | | 1.224 |
| 14 mm | 0,2183 | 72 | | 1.224 |
| 18 mm | 0,2985 | 72 | | 864 |

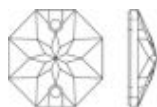

I.0631 - FLAT BACK - to fix - ASFOUR

| | | | | |
|-------|--------|----|--|-------|
| 14 mm | 0,2399 | 72 | | 1.224 |
|-------|--------|----|--|-------|

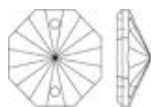

I.0632 - FLAT BACK - to fix - ASFOUR

| | | | | |
|-------|--------|----|--|-------|
| 12 mm | 0,1714 | 72 | | 1.224 |
| 14 mm | 0,2183 | 72 | | 1.224 |
| 22 mm | 0,8015 | 45 | | 540 |

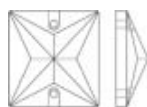

I.0634 - FLAT BACK - to fix - ASFOUR

| | | | | |
|-------|--------|----|--|-------|
| 12 mm | 0,2418 | 72 | | 1.224 |
| 14 mm | 0,3109 | 72 | | 1.224 |

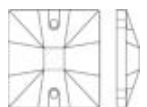

I.0684 - FLAT BACK - to fix - ASFOUR

| | | | | |
|-------|--------|----|--|-----|
| 26 mm | 1,3704 | 16 | | 336 |
|-------|--------|----|--|-----|



I.0642 - FLAT BACK - to fix - ASFOUR

| | | | | |
|-------|--------|----|--|-------|
| 12 mm | 0,3224 | 72 | | 1.224 |
| 14 mm | 0,4606 | 72 | | 1.224 |



I.0602 - FLAT BACK - to fix - ASFOUR

| | | | | |
|-------|--------|----|--|-------|
| 18 mm | 0,3455 | 96 | | 1.152 |
|-------|--------|----|--|-------|

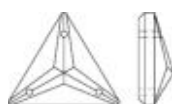

I.0603 - FLAT BACK - to fix - ASFOUR

| | | | | |
|-------|--------|----|--|-------|
| 18 mm | 0,3455 | 96 | | 1.152 |
|-------|--------|----|--|-------|

| CRYSTAL | minimum quantity | | |
|-------------------|--------------------|-------------------|--|
| FOILED | | | |
| EURO piece | PACK pieces | BOX pieces | |

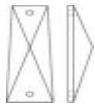

I.0609 - FLAT BACK - to fix - ASFOUR

51 mm

| | | |
|--------|----|-----|
| 1,5024 | 12 | 252 |
|--------|----|-----|

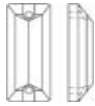

I.0608 - FLAT BACK - to fix - ASFOUR

18 mm
26 mm

| | | |
|--------|----|-------|
| 0,2764 | 72 | 1.008 |
| 0,5067 | 72 | 1.008 |

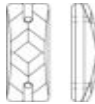

I.0605 - FLAT BACK - to fix - ASFOUR

18 mm

| | | |
|--------|----|-------|
| 0,3369 | 72 | 1.224 |
|--------|----|-------|



I.0606 - FLAT BACK - to fix - ASFOUR

18 mm

| | | |
|--------|----|-------|
| 0,4146 | 96 | 1.152 |
|--------|----|-------|

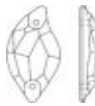

I.0637 - FLAT BACK - to fix - ASFOUR

20 mm
30 mm

| | | |
|--------|----|-------|
| 0,3973 | 72 | 1.224 |
| 0,7421 | 30 | 510 |



I.0699 - FLAT BACK - to fix - ASFOUR

16 mm

| | | |
|--------|----|-------|
| 0,4124 | 72 | 1.224 |
|--------|----|-------|

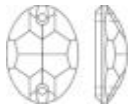

I.0505 - FLAT BACK - to fix - ASFOUR

10 mm
16 mm
24 mm

| | | |
|--------|----|-------|
| 0,2073 | 72 | 2.448 |
| 0,3413 | 72 | 1.224 |
| 0,4606 | 30 | 510 |

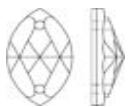

I.0636 - FLAT BACK - to fix - ASFOUR

12 mm
18 mm

| | | |
|--------|----|-------|
| 0,2303 | 72 | 1.224 |
| 0,3685 | 72 | 1.224 |

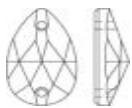

I.6883 - FLAT BACK - to fix - ASFOUR

12 mm
18 mm
28 mm

| | | |
|--------|----|-------|
| 0,2303 | 72 | 2.448 |
| 0,3685 | 72 | 1.224 |
| 0,6910 | 22 | 462 |



I.6873 - FLAT BACK - to fix - ASFOUR

28 mm
38 mm

| | | |
|--------|----|-----|
| 0,7531 | 22 | 462 |
| 1,5671 | 16 | 336 |



I.6911 - FLAT BACK - to fix - ASFOUR

38 mm

| | | |
|--------|----|-----|
| 1,6610 | 16 | 336 |
|--------|----|-----|



I.6870 - FLAT BACK - to fix - ASFOUR

28 mm

| | | |
|--------|----|-----|
| 1,3357 | 16 | 336 |
|--------|----|-----|

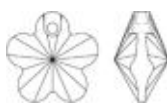

I.0101 - FLAT BACK - to fix - ASFOUR

12 mm

| | | |
|--------|----|-----|
| 0,4197 | 72 | 936 |
|--------|----|-----|

CRYSTAL DOWNLIGHT ORNAMENTATIONS

DROP DECORATION

I.9711

1 piece / BOX



42,8228

ICICLE DECORATION

I.9713

1 piece / BOX



56,7829

I.9712

1 piece / BOX



59,7782

I.9714

1 piece / BOX



73,7383

Top Crystals ... in CRYSTAL CLEAR... Bottom Crystals ... available in :

CRYSTAL CLEAR

COLORS (ALEXANDRITE, AMETHYST, AQUAMARINE, EMERALD, JET, ROSALIN, RUBY, SAPPHIRE, SMOKE, TOPAZ)

Metal Ring ... available in :

BRASS

CHROME

Pinning Material ... available in :

BRASS

CHROME

GOLD

Metal Ring size: 96mm (outside) x 92mm (outside) x 66mm (inside) x 10mm (height)

| CRYSTAL | CRYSTAL <u>coated</u> | COLOR | |
|---------------|--|--|---------------|
| CLEAR | AB AFLAME AMBER ANTIQUE GOLD SILVER | ALEXANDRITE AMETHYST AQUAMARINE EMERALD JET ROSALIN RUBY SAPPHIRE SMOKE TOPAZ | |
| EURO piece | EURO piece | EURO piece | BOX pieces |

CRYSTAL LED-DOWNLIGHT ORNAMENTATIONS

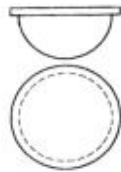

I.9910

diameter (outside): 33,5 mm - diameter (inside): 28,5 mm

| | | | | |
|-------|--------|--------|--------|----|
| 17 mm | 5,3458 | 6,5555 | 7,2435 | 96 |
|-------|--------|--------|--------|----|



I.9920

diameter (outside): 33,5 mm - diameter (inside): 28,5 mm

| | | | | |
|-------|--------|--------|--------|----|
| 16 mm | 5,3458 | 6,5555 | 7,2435 | 96 |
|-------|--------|--------|--------|----|



I.9930

diameter (outside): 33,5 mm - diameter (inside): 28,5 mm

| | | | | |
|-------|--------|--------|--------|----|
| 33 mm | 5,9181 | 6,9677 | 7,5904 | 48 |
|-------|--------|--------|--------|----|



I.9940

diameter (outside): 55 mm - diameter (inside): 46+49 mm

| | | | | |
|-------|---------|---------|---------|----|
| 46 mm | 18,5687 | 21,8833 | 23,4321 | 10 |
|-------|---------|---------|---------|----|



I.9950

diameter (outside): 55 mm - diameter (inside): 47 mm

| | | | | |
|-------|---------|---------|---------|----|
| 58 mm | 19,3411 | 22,6557 | 23,7354 | 10 |
|-------|---------|---------|---------|----|

CRYSTAL CURTAINS

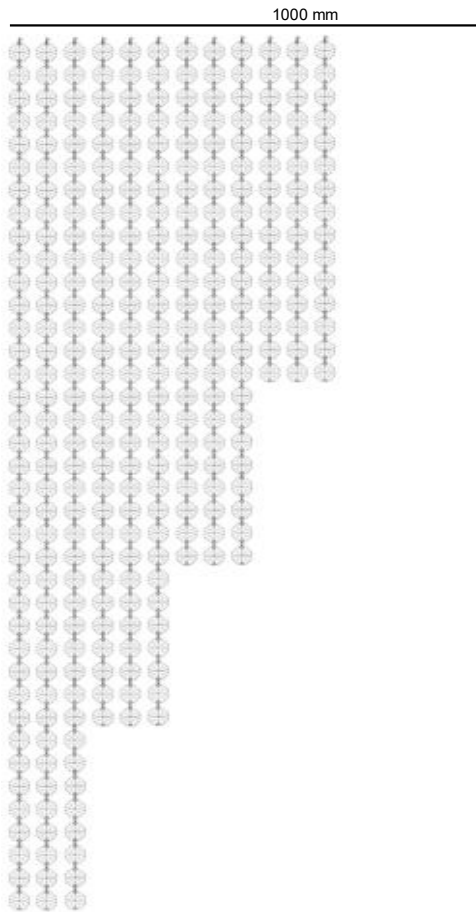

I.9701 - CRYSTAL CURTAIN (FANTASTIC octagons F.3200/14mm)

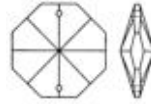

1000 mm

| | |
|---|-----------|
| <u>1000 mm x 1000 mm (with 9 mm pinning)</u> | 697,4468 |
| <u>1000 mm x 1000 mm (with 11 mm pinning)</u> | 664,1250 |
| <u>1500 mm x 1000 mm (with 9 mm pinning)</u> | 1046,1701 |
| <u>1500 mm x 1000 mm (with 11 mm pinning)</u> | 996,1875 |
| <u>2000 mm x 1000 mm (with 9 mm pinning)</u> | 1394,8935 |
| <u>2000 mm x 1000 mm (with 11 mm pinning)</u> | 1328,2500 |
| <u>2500 mm x 1000 mm (with 9 mm pinning)</u> | 1743,6169 |
| <u>2500 mm x 1000 mm (with 11 mm pinning)</u> | 1660,3125 |

I.9702 - CRYSTAL CURTAIN (FANTASTIC octagons F.3300/14mm)

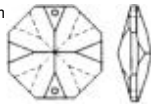

1500 mm

2000 mm

2500 mm

| | |
|---|-----------|
| <u>1000 mm x 1000 mm (with 9 mm pinning)</u> | 803,3400 |
| <u>1000 mm x 1000 mm (with 11 mm pinning)</u> | 757,7998 |
| <u>1500 mm x 1000 mm (with 9 mm pinning)</u> | 1205,0101 |
| <u>1500 mm x 1000 mm (with 11 mm pinning)</u> | 1136,6997 |
| <u>2000 mm x 1000 mm (with 9 mm pinning)</u> | 1606,6801 |
| <u>2000 mm x 1000 mm (with 11 mm pinning)</u> | 1515,5997 |
| <u>2500 mm x 1000 mm (with 9 mm pinning)</u> | 2008,3501 |
| <u>2500 mm x 1000 mm (with 11 mm pinning)</u> | 1894,4996 |

available pinning-style

* CONNECTOR-pinning ... classic style



* PLAIN-CLIP-pinning ... modern style

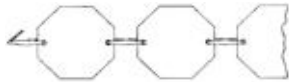

pinning-material

available in
BRASS
CHROME
GOLD

available pinning-sizes

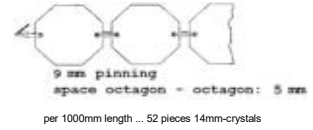

other combinations

of crystal-sizes
or coatings
or colors
are available
on request.

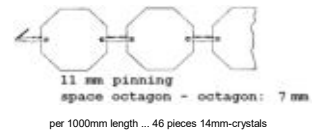

1000 mm ... for 60 crystal chains



I.9709 - SUSPENSION (stainless-steel)

1000mm x 30mm x 4mm STAINLESS-STEEL | 148,2012
straight, with 2 holes Ø8mm for hanging on ceiling etc.

other lengths : | on request

other shapes, for example : | on request

45°-angle, with 2 holes Ø8mm for screwing on ceiling etc.

example of application :



| | | | | |
|---------------|---------------|---------------|---------------|---------------|
| EURO piece | EURO piece | EURO piece | EURO piece | EURO piece |
|---------------|---------------|---------------|---------------|---------------|

CRYSTAL MIRRORS

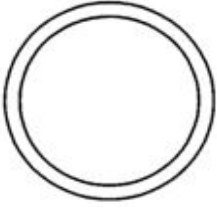

I.0630 - MIRROR

BOX pieces

| <u>25 mm</u> | <u>38 mm</u> | <u>50 mm</u> | <u>63 mm</u> | <u>76 mm</u> |
|--------------|--------------|--------------|--------------|--------------|
| 200 | 100 | 70 | 50 | 50 |

CRYSTAL FOILED

| | | | | |
|--------|--------|--------|--------|--------|
| 1,3787 | 1,9450 | 2,1748 | 2,6123 | 2,8724 |
|--------|--------|--------|--------|--------|

BOX pieces

| <u>89 mm</u> | <u>100 mm</u> | <u>125 mm</u> | <u>150 mm</u> | <u>200 mm</u> |
|--------------|---------------|---------------|---------------|---------------|
| 50 | 50 | 40 | 40 | 40 |

CRYSTAL FOILED

| | | | | |
|--------|--------|--------|--------|--------|
| 2,9955 | 3,5453 | 4,4809 | 5,5806 | 7,8785 |
|--------|--------|--------|--------|--------|

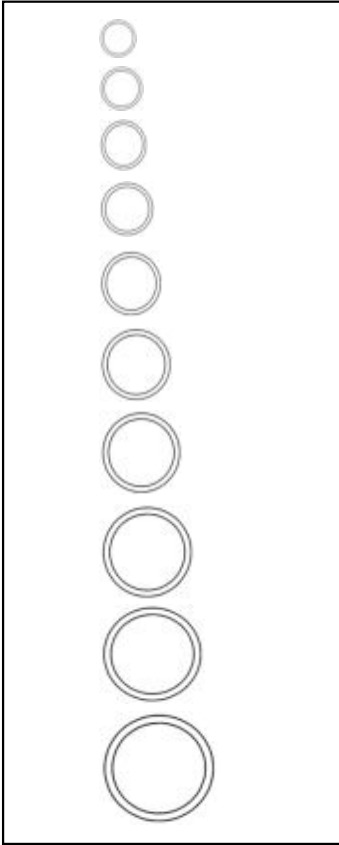

I.0630 - SET ... 1 piece of each size (= 10 different sizes) :

CRYSTAL FOILED

| |
|---------|
| 35,4641 |
|---------|

EURO
piece

EURO
piece

EURO
piece

EURO
piece

EURO
piece

CRYSTAL FACETED STONES



I.0640 - BALL

BAG pieces

| | <u>6 mm</u> | <u>8 mm</u> | <u>10 mm</u> | <u>12 mm</u> | <u>14 mm</u> |
|-----------------|-------------|-------------|--------------|--------------|--------------|
| CRYSTAL CLEAR | 0,1095 | 0,1196 | 0,1380 | 0,2208 | 0,3373 |
| CRYSTAL AB | 0,2425 | 0,2526 | 0,2710 | 0,3538 | 0,4703 |
| CRYSTAL AFLAME | 0,2425 | 0,2526 | 0,2710 | 0,3538 | 0,4703 |
| CRYSTAL AMBER | 0,2425 | 0,2526 | 0,2710 | 0,3538 | 0,4703 |
| CRYSTAL ANTIQUE | 0,2425 | 0,2526 | 0,2710 | 0,3538 | 0,4703 |
| CRYSTAL GOLD | 0,2425 | 0,2526 | 0,2710 | 0,3538 | 0,4703 |
| CRYSTAL SILVER | 0,2425 | 0,2526 | 0,2710 | 0,3538 | 0,4703 |
| CRYSTAL BB | 0,2425 | 0,2526 | 0,2710 | 0,3538 | 0,4703 |
| CRYSTAL BW | 0,2425 | 0,2526 | 0,2710 | 0,3538 | 0,4703 |
| CRYSTAL OG | 0,2425 | 0,2526 | 0,2710 | 0,3538 | 0,4703 |
| CRYSTAL OS | 0,2425 | 0,2526 | 0,2710 | 0,3538 | 0,4703 |
| CRYSTAL VL | 0,2425 | 0,2526 | 0,2710 | 0,3538 | 0,4703 |
| CRYSTAL VM | 0,2425 | 0,2526 | 0,2710 | 0,3538 | 0,4703 |

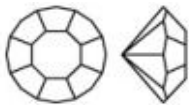

I.0643 - DIAMOND

BAG pieces

| | <u>4 mm</u> | <u>6 mm</u> | <u>8 mm</u> | <u>10 mm</u> | <u>12 mm</u> |
|---------------|-------------|-------------|-------------|--------------|--------------|
| CRYSTAL CLEAR | 0,0059 | 0,0134 | 0,0221 | 0,0270 | 0,0713 |

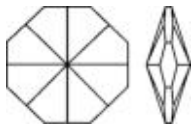

I.0647 - OCTAGON

BOX pieces

| | <u>14 mm</u> | | | | |
|-----------------|--------------|--|--|--|--|
| CRYSTAL CLEAR | 0,1556 | | | | |
| CRYSTAL AB | 0,2878 | | | | |
| CRYSTAL AFLAME | 0,2878 | | | | |
| CRYSTAL AMBER | 0,2878 | | | | |
| CRYSTAL ANTIQUE | 0,2878 | | | | |
| CRYSTAL GOLD | 0,2878 | | | | |
| CRYSTAL SILVER | 0,2878 | | | | |
| CRYSTAL BB | 0,2878 | | | | |
| CRYSTAL BW | 0,2878 | | | | |
| CRYSTAL OG | 0,2878 | | | | |
| CRYSTAL OS | 0,2878 | | | | |
| CRYSTAL VL | 0,2878 | | | | |
| CRYSTAL VM | 0,2878 | | | | |

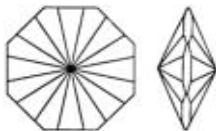

I.0648 - OCTAGON

BOX pieces

| | <u>32 mm</u> | | | | |
|-----------------|--------------|--|--|--|--|
| CRYSTAL CLEAR | 0,6488 | | | | |
| CRYSTAL AB | 1,2052 | | | | |
| CRYSTAL AFLAME | 1,2052 | | | | |
| CRYSTAL AMBER | 1,2052 | | | | |
| CRYSTAL ANTIQUE | 1,2052 | | | | |
| CRYSTAL GOLD | 1,2052 | | | | |
| CRYSTAL SILVER | 1,2052 | | | | |
| CRYSTAL BB | 1,2052 | | | | |
| CRYSTAL BW | 1,2052 | | | | |
| CRYSTAL OG | 1,2052 | | | | |
| CRYSTAL OS | 1,2052 | | | | |
| CRYSTAL VL | 1,2052 | | | | |
| CRYSTAL VM | 1,2052 | | | | |



I.0649 - ASYMETRIC

BAG (1kg) pieces

| | <u>19x13 mm</u> | <u>23x16 mm</u> | | | |
|-----------------|-----------------|-----------------|--|--|--|
| CRYSTAL CLEAR | 500 | 300 | | | |
| CRYSTAL AB | 0,0241 | 0,0449 | | | |
| CRYSTAL AFLAME | 0,3361 | 0,4591 | | | |
| CRYSTAL AMBER | 0,3361 | 0,4591 | | | |
| CRYSTAL ANTIQUE | 0,3361 | 0,4591 | | | |
| CRYSTAL GOLD | 0,3361 | 0,4591 | | | |
| CRYSTAL SILVER | 0,3361 | 0,4591 | | | |
| CRYSTAL BB | 0,3361 | 0,4591 | | | |
| CRYSTAL BW | 0,3361 | 0,4591 | | | |
| CRYSTAL OG | 0,3361 | 0,4591 | | | |
| CRYSTAL OS | 0,3361 | 0,4591 | | | |
| CRYSTAL VL | 0,3361 | 0,4591 | | | |
| CRYSTAL VM | 0,3361 | 0,4591 | | | |

CRYSTAL in KILOGRAM

I.9741 - CRYSTAL in KILOGRAM

| | | |
|---|---|--------|
| CLEAR / 14MM ... only 14mm-size |  | 28,000 |
| CLEAR+COLOR / 14MM ... only 14mm-size |  | 43,000 |
| COLOR / 14MM ... only 14mm-size |  | 58,000 |
| CLEAR / SMALL ... below 50mm-size |  | 17,000 |
| CLEAR+COLOR / SMALL ... below 50mm-size |  | 25,000 |
| COLOR / SMALL ... below 50mm-size |  | 35,000 |
| CLEAR / BIG ... over 50mm-size |  | 17,000 |
| CLEAR+COLOR / BIG ... over 50mm-size |  | 25,000 |
| COLOR / BIG ... over 50mm-size |  | 35,000 |

The shapes and colors vary and it is not 1st quality!

EURO

kg

ROCKCRYSTAL in KILOGRAM

I.9771 - ROCKCRYSTAL in KILOGRAM

SMALL+BIG

| 50,2270 |



The shapes vary and the maximum size is 50mm !



DECORATION

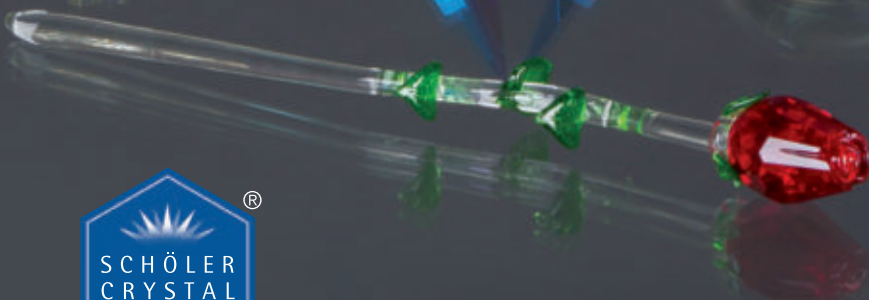

DECORATION

fine crystal

premium quality

skillfully hand-made

sensational collectibles & gifts

gift-box-packing available

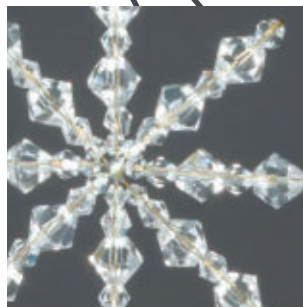
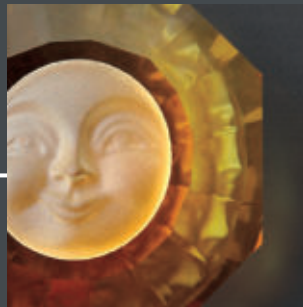

Schöler & Co. GmbH

Gablonzer Strasse 54-61
A-4550 Kremsmünster
Austria

T: ++43-75 83-77 23

F: ++43-75 83-78 12

E: office@scholer-crystal.at

W: www.scholer-crystal.at



ARTICLE INDEX

| Art.No.: | Page: | Art.No.: | Page: | Art.No.: | Page: | Art.No.: | Page: | Art.No.: | Page: |
|-----------------|--------------|-----------------|--------------|-----------------|--------------|-----------------|--------------|-----------------|--------------|
| D.0401 | 18 | D.1100 | 66 | D.1403 | 64 | D.1801 | 51 | D.2300 | 67 |
| D.0479 | 24 | D.1101 | 37 | D.1404 | 64 | D.1802 | 51 | D.2600 | 34 |
| D.0489 | 24 | D.1102 | 37 | D.1405 | 64 | D.1803 | 51 | D.2602 | 34 |
| D.0499 | 19 | D.1103 | 37 | D.1406 | 64 | D.1804 | 51 | D.2603 | 35 |
| D.0536 | 20 | D.1104 | 37 | D.1407 | 64 | D.1805 | 51 | D.2604 | 35 |
| D.0537 | 20 | D.1105 | 37 | D.1408 | 64 | D.1806 | 51 | D.2605 | 35 |
| D.0538 | 20 | D.1106 | 37 | D.1501 | 65 | D.1807 | 51 | D.2606 | 35 |
| D.0542 | 25 | D.1107 | 37 | D.1502 | 65 | D.1808 | 51 | D.2607 | 35 |
| D.0544 | 25 | D.1108 | 37 | D.1503 | 65 | D.1809 | 51 | D.2608 | 35 |
| D.0546 | 25 | D.1166 | 38 | D.1504 | 65 | D.1810 | 51 | D.2611 | 66 |
| D.0548 | 25 | D.1170 | 36 | D.1505 | 65 | D.1811 | 52 | D.2623 | 67 |
| D.0602 | 29 | D.1175 | 36 | D.1506 | 65 | D.1812 | 52 | D.2679 | 22 |
| D.0604 | 29 | D.1177 | 38 | D.1507 | 65 | D.1813 | 52 | D.2681 | 22 |
| D.0610 | 29 | D.1180 | 36 | D.1508 | 65 | D.1814 | 52 | D.2687 | 22 |
| D.0623 | 28 | D.1185 | 36 | D.1509 | 65 | D.1815 | 52 | D.2778 | 22 |
| D.0624 | 28 | D.1187 | 39 | D.1510 | 65 | D.1816 | 52 | D.2783 | 22 |
| D.0626 | 21 | D.1188 | 38 | D.1511 | 65 | D.1817 | 52 | D.2793 | 22 |
| D.0627 | 21 | D.1189 | 39 | D.1512 | 65 | D.1818 | 52 | D.2794 | 22 |
| D.0628 | 21 | D.1190 | 36 | D.1600 | 46 | D.1819 | 52 | D.2880 | 23 |
| D.0629 | 21 | D.1193 | 36 | D.1610 | 46 | D.1820 | 52 | D.2881 | 23 |
| D.0630 | 26 | D.1195 | 36 | D.1620 | 46 | D.1821 | 53 | D.2885 | 23 |
| D.0632 | 26 | D.1197 | 36 | D.1721 | 47 | D.1822 | 53 | D.2890 | 23 |
| D.0634 | 26 | D.1199 | 38 | D.1722 | 47 | D.1823 | 53 | D.2900 | 13 |
| D.0636 | 26 | D.1217 | 43 | D.1730 | 47 | D.1824 | 53 | D.2902 | 13 |
| D.0649 | 24 | D.1218 | 43 | D.1731 | 47 | D.1825 | 53 | D.2903 | 13 |
| D.0650 | 24 | D.1220 | 31 | D.1732 | 47 | D.1826 | 53 | D.2904 | 13 |
| D.0665 | 27 | D.1221 | 30 | D.1740 | 47 | D.1827 | 53 | D.2905 | 13 |
| D.0668 | 27 | D.1222 | 30 | D.1752 | 48 | D.1828 | 53 | D.2910 | 14 |
| D.0671 | 27 | D.1224 | 31 | D.1753 | 49 | D.1829 | 53 | D.2915 | 14 |
| D.0675 | 27 | D.1225 | 30 | D.1760 | 42 | D.1830 | 53 | D.2930 | 14 |
| D.0711 | 68+69 | D.1226 | 30 | D.1771 | 70+71 | D.1831 | 54 | D.2940 | 15 |
| D.0810 | 32+33 | D.1228 | 31 | D.1772 | 70+71 | D.1832 | 54 | D.2941 | 15 |
| D.0811 | 32+33 | D.1250 | 45 | D.1773 | 70+71 | D.1833 | 54 | D.2943 | 15 |
| D.0812 | 32+33 | D.1251 | 45 | D.1774 | 70+71 | D.1834 | 54 | D.2945 | 15 |
| D.0820 | 32+33 | D.1252 | 45 | D.1775 | 70+71 | D.1835 | 54 | D.2950 | 17 |
| D.0821 | 32+33 | D.1254 | 45 | D.1776 | 70+71 | D.1836 | 54 | D.2960 | 17 |
| D.0822 | 32+33 | D.1255 | 45 | D.1778 | 70+71 | D.1837 | 54 | D.2960/1 | 72 |
| D.0830 | 32+33 | D.1256 | 45 | D.1779 | 70+71 | D.1838 | 54 | D.2960/2 | 72 |
| D.0831 | 32+33 | D.1258 | 39 | | | D.1839 | 54 | D.2971 | 16 |
| D.0832 | 32+33 | D.1259 | 39 | | | D.1840 | 54 | D.2973 | 16 |
| D.0840 | 32+33 | D.1263 | 40 | | | D.1841 | 55 | D.2980 | 14 |
| D.0841 | 32+33 | D.1264 | 41 | | | D.1842 | 55 | D.3291 | 42 |
| D.0842 | 32+33 | D.1283 | 40 | | | D.1843 | 55 | D.3660 | 62 |
| D.0850 | 32+33 | D.1284 | 41 | | | D.1844 | 55 | D.3661 | 62 |
| D.0851 | 32+33 | D.1293 | 40 | | | D.1845 | 55 | D.3662 | 62 |
| D.0852 | 32+33 | D.1294 | 41 | | | D.1846 | 55 | D.3663 | 62 |
| D.0860 | 32+33 | D.1330 | 34 | | | D.1847 | 55 | D.3880 | 60 |
| D.0861 | 32+33 | D.1340 | 34 | | | D.1848 | 55 | D.3881 | 60 |
| D.0862 | 32+33 | D.1350 | 34 | | | D.1849 | 55 | D.3882 | 60 |
| | | D.1353 | 34 | | | D.1850 | 55 | D.3883 | 60 |
| | | | | | | D.1891 | 56 | D.3927 | 44 |
| | | | | | | D.1892 | 57 | D.3929 | 44 |
| | | | | | | D.1900 | 44 | D.4660 | 63 |
| | | | | | | D.1921 | 58 | D.4661 | 63 |
| | | | | | | D.1931 | 59 | D.4662 | 63 |
| | | | | | | | | D.4663 | 63 |
| | | | | | | | | D.4880 | 61 |
| | | | | | | | | D.4881 | 61 |
| | | | | | | | | D.4882 | 61 |
| | | | | | | | | D.4883 | 61 |

GENERAL INFORMATION

Advanced technology and skilled craftsmanship form the product SCHÖLER CRYSTAL, crystals of finest quality and high value. Minor deviations in dimensions, crystal thickness, nuances in color, and occasional bubbles are a typical sign of handcrafting.

This catalog/pricelist shows a selection of our crystals. If you prefer your own designs, do not hesitate to ask for an offer. We will be glad to produce exclusively for you !

COATINGS & COLORS

CRYSTAL CLEAR ... transparent

CRYSTAL AB ... Aurora Borealis ... transparent with rosalin coating-color on one surface

CRYSTAL AFLAME ... transparent with fire-flame redcoating-color on one surface

CRYSTAL AMBER ... transparent with light-gold coating-color on one surface

CRYSTAL ANTIQUE ... transparent with smoke coating-color on one surface

CRYSTAL GOLD ... transparent with gold coating-color on one surface

CRYSTAL SILVER ... transparent with silver coating-color on one surface

CRYSTAL BB ... Bermuda Blue ... non-transparent with violet coating-color on one surface and finally the same color is added on the back

CRYSTAL BW ... Bermuda Water ... non-transparent with blue coating-color on one surface and finally the same color is added on the back

CRYSTAL OG ... Orbit Gold ... non-transparent with gold coating-color on one surface and finally the same color is added on the back

CRYSTAL OS ... Orbit Silver ... non-transparent with silver coating-color on one surface and finally the same color is added on the back

CRYSTAL VL ... Vitrail Light ... non-transparent with light-violet coating-color on one surface and finally the same color is added on the back

CRYSTAL VM ... Vitrail Medium ... non-transparent with green&violet coating-color on one surface and finally the same color is added on the back

CRYSTAL FOILED ... transparent with mirror coating-color on one surface ... same as CRYSTAL OS

CRYSTAL MOONLIGHT is a special effect , created by sandblasting and applying an AB-color

ALEXANDRITE light purple

AMETHYST purple

AQUAMARINE light blue-green

COPPER brown

EMERALD green

JET black

MULTICOLOR mixture of different colors

ROSALIN pink

RUBY red

SAPPHIRE blue

SMOKE grey

TOPAZ light brown

WHITE white

YELLOW yellow

PACKING

BOX pcs. ... a box is a small carton

CARTON pcs. ... a carton includes several boxes, usually a dozen

Standard-Export-Packing ... is included in all our prices !

All shipments are carefully packed and checked by experienced professional packers !

SPECIAL PACKING

SINGLE PACKING ... surcharge ... +5% (on merchandise-value)

SET PACKING ... surcharge ... +3% (on merchandise-value)

PRICES

EURO / piece ... our prices are quoted in European Currency (EURO) per piece

EURO / kg ... only a few articles are quoted in European Currency (EURO) per kg

Prices are subject to change without notice.

EXW (Ex Works) ... truck-/sea-/air-/courier-/mail-shipments

MINIMUM - ORDER - VALUE

EURO 250,-- ... per shipment

with regard to existing minimum-quantities or packing-units ... per article/size

REDUCED - QUANTITY - ORDER

surcharge ... +25%

It is not possible to supply most articles in smaller quantities than the mentioned minimum-quantity or packing-unit.

Where possible to do so a 25% surcharge will be applied.

BACKORDERS

Backorders with a value of less than EURO 25,-- are automatically cancelled.

All items not shipped are automatically placed on backorder.

If you do not wish to receive backorders, please notify us and your request will become part of your file.

SAMPLES

surcharge ... +25%

We are pleased to send you samples of all requested articles, but we have to charge them to you (with a surcharge of +25%).

Exceptions from sample-invoicing are possible on inquiry.

CLAIMS

All claims for defective merchandise must be made within 5 business days of receipt.

Merchandise cannot be returned after 30 days of receipt. Merchandise must be in same condition as received.

No returns will be accepted without verbal or written permission. Unauthorized returns will be refused.

SILKSCREEN-PRINT - LOGO:

finishing: one-color or two-color or four-color
film-generating-costs (one time only): on inquiry (depending on motif)
printer-adjustment-costs (per order): on inquiry (depending on motif)
printing-costs (per piece): on inquiry (depending on motif)
minimum-order-quantity: 100 pieces
delivery-time: 2 weeks (after receipt of original logo)

SANDBLASTING - LOGO:

finishing: sandblasted (colors not possible)
sandblasting-costs (per piece): on inquiry (depending on motif)
minimum-order-quantity: 100 pieces
delivery-time: 2 weeks (after receipt of original logo)

ENGRAVING - LOGO:

finishing: engraved (colors not possible)
engraving-costs (per piece): on inquiry (depending on motif)
minimum-order-quantity: 1 piece
delivery-time: 2 weeks (after receipt of original logo)

LASER - LOGO:

finishing #A): lasered 3D-motif inside the crystal (colors not possible)
finishing #B): lasered 2D-motif on the surface of the crystal (colors not possible)
program-generating-costs (one time only): on inquiry (depending on motif)
laser-adjustment-costs (per order): on inquiry (depending on motif)
lasering-costs (per piece): on inquiry (depending on motif)
minimum-order-quantity: 100 pieces
delivery-time: 2 weeks (after receipt of original logo)

PACKINGS

NORMALBOX - PACKING:

price: is included in the prices

neutral
carton box

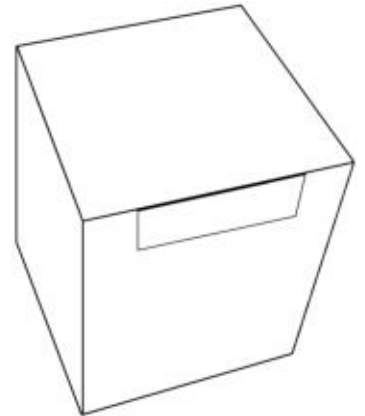

GIFTBOX - PACKING:

price: 1,3271 EURO/piece

multi-color
transparent
plastic-box

showing the
international
brand-name
SCHÖLER CRYSTAL

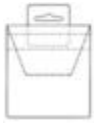

EURO
pieceEURO
pieceEURO
pieceEURO
pieceEURO
piece**BAGS****D.2900 - POLY-BAG for CRYSTALS**

MINIMUM pieces

TRANSPARENT

100x90 mm

1

| 0,5744 |

**D.2902 - PAPER-BAG for CRYSTALS**

MINIMUM pieces

SAPPHIRE

110x75 mm

1

140x105 mm

1

170x115 mm

1

| 0,1754 |

| 0,2285 |

| 0,2821 |

**D.2903 - ORGANZA-BAG for CRYSTALS**

MINIMUM pieces

SILVER

(translucent)

75x50 mm

1

100x75 mm

1

150x100 mm

1

| 0,2406 |

| 0,2406 |

| 0,2646 |

200x125 mm

1

225x150 mm

1

300x200 mm

1

| 0,3608 |

| 0,4956 |

| 0,5451 |

**D.2904 - VELVET-BAG for CRYSTALS**

MINIMUM pieces

SAPPHIRE

(normal)

70x50 mm

1

100x60 mm

1

| 1,2759 |

| 1,4885 |

140x100 mm

1

200x130 mm

1

| 1,9846 |

| 3,4729 |

**D.2905 - VELVET-BAG for CRYSTALS**

MINIMUM pieces

SAPPHIRE

(special)

125x110 mm

1

| 0,9318 |

EURO
piece

EURO
piece

EURO
piece

EURO
piece

EURO
piece

DISPLAYS



D.2910 - LIGHTCHANGING-DISPLAY for CRYSTALS

BOX pieces

100x20 mm

1

SILVER & MIRROR

| 5,6586 |

* plastic (silver color) with mirror on top

* changing lights (emerald, ruby, sapphire, topaz)

* powered by battery (not included) or adapter (not included)



D.2915 - TURNTABLE-DISPLAY for CRYSTALS

BOX pieces

225x60 mm

1

SILVER & MIRROR

| 53,2192 |

* plastic with mirror on top

* powered by battery (not included) or adapter (not included)



D.2930 - TRAY-DISPLAY for CRYSTALS

BOX pieces

342x122 mm

6

TRANSPARENT

| 0,6085 |

* put the crystals into this transparent display,
and you will have a favourable and flexible presentation of crystals

* put on a second one inverted and use two rubber rings for fixing,
and you have a perfect as well as a transparent sample-packaging

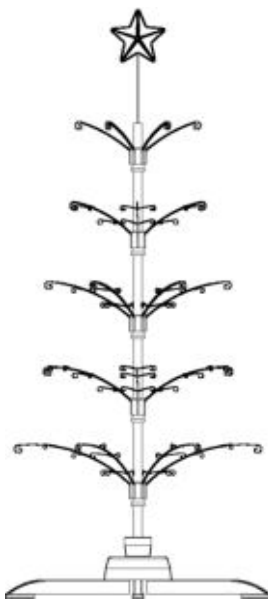

D.2980 - METAL-DISPLAY for CRYSTALS

BOX pieces

2250x900 mm

1

CHROME

| 264,6875 |

* powered by electricity
to rotate

* hang in crystals at the 5 horizontal rows (each with 6 arms)
and you have a great presentation of the crystals

EURO
pieceEURO
pieceEURO
pieceEURO
pieceEURO
piece

DISPLAYS



D.2940 - SPIRAL-DISPLAY for CRYSTALS

600 mm

BOX pieces

1

TRANSPARENT

| 55,8206 |

* acrylic glass

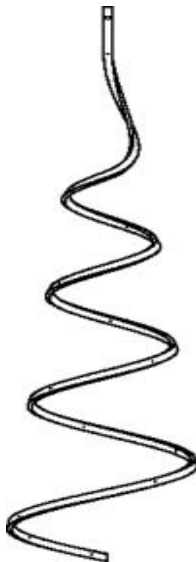
* 18 holes for hanging crystals
(hang the crystals with the chrome-hooks)* top-diameter: approx. 100mm
bottom-diameter: approx. 200mm

D.2941 - SPIRAL-DISPLAY for CRYSTALS

750 mm

BOX pieces

1

TRANSPARENT

| 74,4275 |

* acrylic glass

* 12 holes for hanging crystals
(hang the crystals with the chrome-hooks)* top-diameter: approx. 125mm
bottom-diameter: approx. 250mm

D.2943 - SUCTION.CUP-DISPLAY for CRYSTALS

30 mm
with
button30 mm
with
metal-hook30 mm
with
plastic-hook

BAG pieces

10

10

10

TRANSPARENT

| 0,3963 |

0,5451 |

0,5451 |

* put it on a window (window glass or window frame)
hang one crystal on a thread

D.2945 - MAGNET.HOOK-DISPLAY for CRYSTALS

12x35 mm16x32 mm20x35 mm

BAG pieces

1

1

1

CHROME

| 1,8893 |

2,3187 |

4,4656 |

* put it on a metal-material
hang one crystal on a thread

EURO
piece

EURO
piece

EURO
piece

EURO
piece

EURO
piece

DISPLAYS

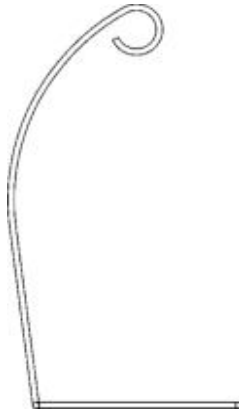

D.2971 - HANGER-DISPLAY for CRYSTALS

200 mm

BOX pieces

1

CHROME

| 41,2785 |

* basic material ... solid brass

* hang in a crystal at the swirl
and you have a great presentation of the crystal

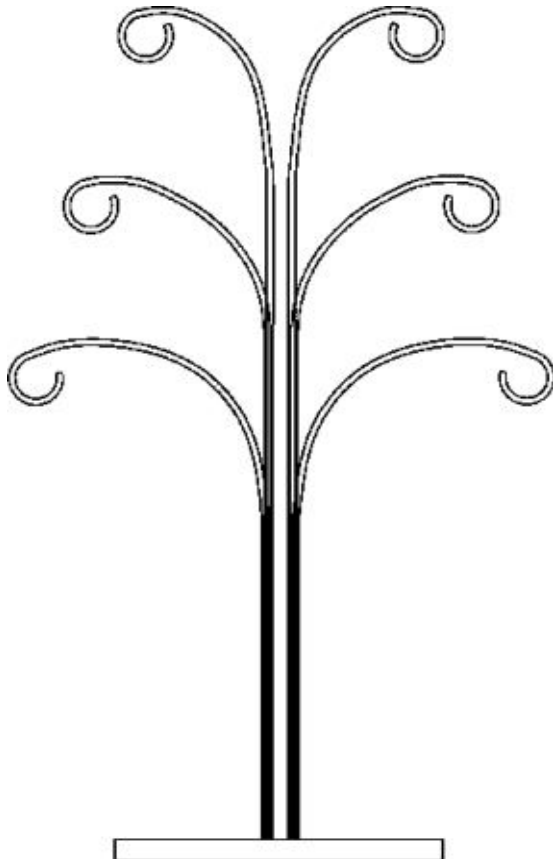

D.2973 - SWIRL-DISPLAY for CRYSTALS

400 mm

BOX pieces

1

CHROME

| 147,4238 |

* basic material ... solid brass

* hang in crystals at the 15 swirls
and you have a great presentation of the crystals

EURO
piece

EURO
piece

EURO
piece

EURO
piece

EURO
piece

DISPLAYS



D.2950 - ARM-DISPLAY for CRYSTALS

BAG pieces

250 mm

300 mm

350 mm

1

1

1

CHROME

| 3,7742 |

| 4,3342 |

| 4,8945 |

* basic material ... solid brass

* pinning service - custom made ... hang on a crystal in the hole at the top of the arm
and you have a great presentation of the crystal; price on request

It looks great if you put this arm-display in a flower pot !

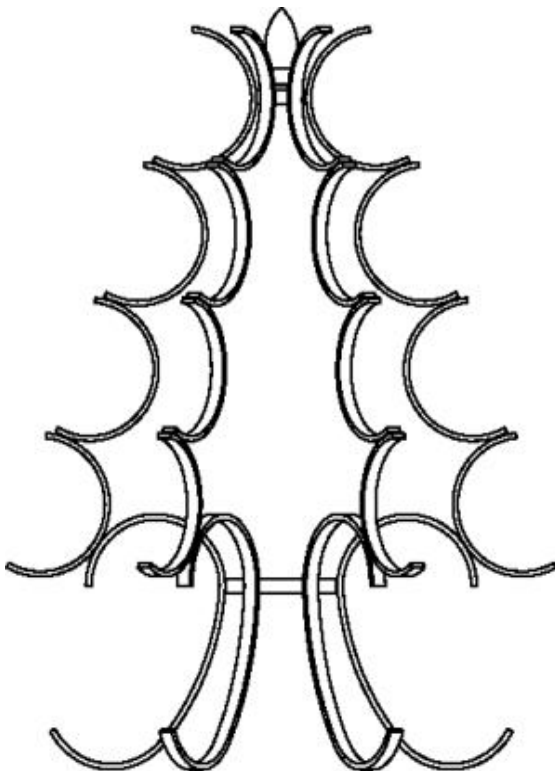

D.2960 - TREE-DISPLAY for CRYSTALS

BOX pieces

375x250 mm

1

CHROME

| 132,6812 |

BROWN

| 132,6812 |

* basic material ... solid brass

* hang in crystals at the 5 vertical rows (each with 6 arms)
and you have a great presentation of the crystals

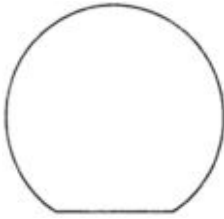
EURO
pieceEURO
pieceEURO
pieceEURO
pieceEURO
piece**FLAT-BASED BALLS****D.0401 - SOLID BALL**

BOX pieces

30 mm
50**40 mm**
20**50mm**
10**60 mm**
10**80 mm**
1

CRYSTAL CLEAR

1,0755

1,7819

3,2328

6,4677

8,0894

CRYSTAL AB

2,1431

3,0833

5,3045

9,5057

15,7211

CRYSTAL MOONLIGHT

4,0579

4,9981

7,5088

11,7102

20,0443

ALEXANDRITE

11,6960

AMETHYST

11,6960

AQUAMARINE

11,6960

EMERALD

11,6960

JET

11,6960

ROSALIN

11,6960

RUBY

11,6960

SAPPHIRE

11,6960

SMOKE

11,6960

TOPAZ

11,6960

BOX pieces

100mm
1**125 mm**
1**150 mm**
1

CRYSTAL CLEAR

19,6516

48,6940

98,3855

BOX pieces

200 mm
1**250 mm**
1

CRYSTAL CLEAR

238,4072

478,2135

BOX pieces

300 mm
1

CRYSTAL CLEAR

1.017,0465

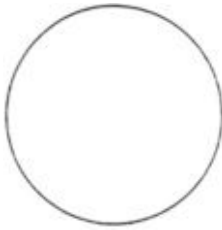
EURO
pieceEURO
pieceEURO
pieceEURO
pieceEURO
piece**ROUND BALLS****D.0499 - SOLID BALL**

BOX pieces

30 mm
50**40 mm**
20**50mm**
10**60 mm**
10**80 mm**
1

CRYSTAL CLEAR

0,9782

1,6200

2,9388

5,8797

7,3541

CRYSTAL AB

2,0458

2,9214

5,0106

8,9177

14,9858

CRYSTAL MOONLIGHT

3,9606

4,8362

7,2126

11,1222

19,2998

ALEXANDRITE

11,6960

AMETHYST

11,6960

AQUAMARINE

11,6960

EMERALD

11,6960

JET

11,6960

ROSALIN

11,6960

RUBY

11,6960

SAPPHIRE

11,6960

SMOKE

11,6960

TOPAZ

11,6960

BOX pieces

100mm
1**125 mm**
1**150 mm**
1

CRYSTAL CLEAR

17,8697

44,2686

89,4461

BOX pieces

200 mm
1**250 mm**
1

CRYSTAL CLEAR

216,7246

452,0044

BOX pieces

300 mm
1

CRYSTAL CLEAR

960,8925

EURO
piece

EURO
piece

EURO
piece

EURO
piece

EURO
piece

BASES FOR BALLS

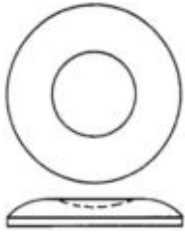

D.0536 - BALL BASE

BOX pieces

40 mm
1

75 mm (individually packed)
1 (in poly-bag)

CRYSTAL CLEAR

| 12,3198 |

21,1289 |

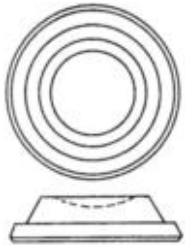

D.0537 - BALL BASE

BOX pieces

27 mm
1

38 mm (individually packed)
1 (in poly-bag)

CRYSTAL CLEAR

| 3,0829 |

4,3298 |

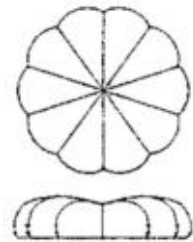

D.0538 - BALL BASE

BOX pieces

50 mm (individually packed)
1 (in poly-bag)

CRYSTAL CLEAR

| 1,6189 |

EURO
piece

EURO
piece

EURO
piece

EURO
piece

EURO
piece

FACETED BALLS



D.0629 - FACETED BALL

BOX pieces

| | <u>20 mm</u> | <u>30 mm</u> | <u>40 mm</u> | <u>50 mm</u> |
|----------------|--------------|--------------|--------------|--------------|
| | 48 | 24 | 20 | 12 |
| CRYSTAL CLEAR | 1,3799 | 1,5025 | 1,7478 | 7,1035 |
| CRYSTAL FOILED | 4,9482 | 6,1481 | 6,6581 | 13,8712 |
| CRYSTAL BB | 4,9482 | 6,1481 | 6,6581 | 13,8712 |
| CRYSTAL VM | 4,9482 | 6,1481 | 6,6581 | 13,8712 |

| | <u>60 mm</u> | <u>70 mm</u> | <u>80 mm</u> | <u>100 mm</u> |
|------------|--------------|--------------|--------------|---------------|
| BOX pieces | 1 | 1 | 1 | 1 |

| | | | | |
|----------------|---------|---------|---------|---------|
| CRYSTAL CLEAR | 10,2128 | 14,8948 | 17,1489 | 34,8391 |
| CRYSTAL FOILED | 19,6139 | 26,3124 | 29,4629 | 53,9659 |
| CRYSTAL BB | 19,6139 | 26,3124 | 29,4629 | 53,9659 |
| CRYSTAL VM | 19,6139 | 26,3124 | 29,4629 | 53,9659 |

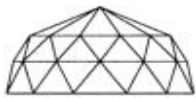

D.0628 - FACETED BALL

BOX pieces

| | <u>20 mm</u> | <u>30 mm</u> | <u>40 mm</u> | <u>50 mm</u> |
|----------------|--------------|--------------|--------------|--------------|
| | 48 | 24 | 20 | 12 |
| CRYSTAL CLEAR | 1,3799 | 1,5025 | 1,7478 | 7,1035 |
| CRYSTAL FOILED | 4,9482 | 6,1481 | 6,6581 | 13,8712 |
| CRYSTAL BB | 4,9482 | 6,1481 | 6,6581 | 13,8712 |
| CRYSTAL VM | 4,9482 | 6,1481 | 6,6581 | 13,8712 |

| | <u>60 mm</u> | <u>70 mm</u> | <u>80 mm</u> | <u>100 mm</u> |
|------------|--------------|--------------|--------------|---------------|
| BOX pieces | 1 | 1 | 1 | 1 |

| | | | | |
|----------------|---------|---------|---------|---------|
| CRYSTAL CLEAR | 10,2128 | 14,8948 | 17,1489 | 34,8391 |
| CRYSTAL FOILED | 19,6139 | 26,3124 | 29,4629 | 53,9659 |
| CRYSTAL BB | 19,6139 | 26,3124 | 29,4629 | 53,9659 |
| CRYSTAL VM | 19,6139 | 26,3124 | 29,4629 | 53,9659 |

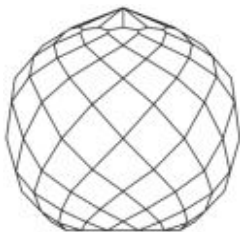

D.0627 - FACETED BALL

BOX pieces

| | <u>60 mm</u> | <u>70 mm</u> | <u>80 mm</u> | <u>100 mm</u> |
|----------------|--------------|--------------|--------------|---------------|
| | 1 | 1 | 1 | 1 |
| CRYSTAL CLEAR | 12,8787 | 17,5436 | 20,8512 | 44,6422 |
| CRYSTAL FOILED | 22,2798 | 28,8913 | 33,1652 | 63,7690 |
| CRYSTAL BB | 22,2798 | 28,8913 | 33,1652 | 63,7690 |
| CRYSTAL VM | 22,2798 | 28,8913 | 33,1652 | 63,7690 |



D.0626 - FACETED BALL

BOX pieces

| | <u>60 mm</u> | <u>70 mm</u> | <u>80 mm</u> | <u>100 mm</u> |
|----------------|--------------|--------------|--------------|---------------|
| | 1 | 1 | 1 | 1 |
| CRYSTAL CLEAR | 12,8787 | 17,5436 | 20,8512 | 44,6422 |
| CRYSTAL FOILED | 22,2798 | 28,8913 | 33,1652 | 63,7690 |
| CRYSTAL BB | 22,2798 | 28,8913 | 33,1652 | 63,7690 |
| CRYSTAL VM | 22,2798 | 28,8913 | 33,1652 | 63,7690 |

EURO
piece

EURO
piece

EURO
piece

EURO
piece

EURO
piece

ARTISTIC BALLS



D.2679 - COMET BALL

BOX pieces

CLEAR / SAPPHIRE / COPPER

80 mm

1

| 27,2329|



D.2681 - BUBBLE BALL

BOX pieces

CLEAR / MULTICOLOR

80 mm

1

| 27,2329|



D.2687 - FANTASY BALL

BOX pieces

CLEAR / SAPPHIRE / YELLOW

80 mm

1

| 27,2329|



D.2778 - FLOWER BALL

BOX pieces

CLEAR / EMERALD / SAPPHIRE

80 mm

1

| 27,2329|



D.2783 - FLOWER BALL

BOX pieces

CLEAR / WHITE / EMERALD

80 mm

1

| 27,2329|



D.2793 - FLOWER EGG

BOX pieces

CLEAR / WHITE / SAPPHIRE

90 mm

1

| 27,2329|



D.2794 - FLOWER EGG

BOX pieces

CLEAR / SAPPHIRE / WHITE

90 mm

1

| 27,2329|

EURO
piece

EURO
piece

EURO
piece

EURO
piece

EURO
piece

GLOBE BALLS



D.2880 - GLOBE

BOX pieces

CRYSTAL CLEAR

(wood-base: brown)

60 mm
1

80 mm
1

100 mm
1

150 mm
1

200 mm
1

| | | | | |
|---------|---------|---------|----------|----------|
| 10,1677 | 15,1619 | 42,4840 | 200,6062 | 394,7531 |
|---------|---------|---------|----------|----------|



D.2881 - GLOBE

BOX pieces

CRYSTAL CLEAR

(metal-base: gold-plated)

100x60 mm
1

| | | | | |
|---------|--|--|--|--|
| 42,2995 | | | | |
|---------|--|--|--|--|



D.2885 - SNOWGLOBE

BOX pieces

CRYSTAL CLEAR

(plastic-base: black)

120x80 mm
1

| | | | | |
|---------|--|--|--|--|
| 21,1832 | | | | |
|---------|--|--|--|--|

ORIGINAL
VIENNA
SNOWGLOBE

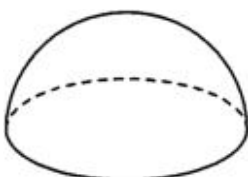

D.2890 - HEMISPHERE

BOX pieces

CRYSTAL CLEAR

50x25 mm
20

75x38 mm
1

100x50 mm
1

125x63 mm
1

| | | | | |
|--------|--------|---------|---------|--|
| 3,0268 | 5,9184 | 13,0624 | 23,6922 | |
|--------|--------|---------|---------|--|

| | | | | |
|---------------|---------------|---------------|---------------|---------------|
| EURO piece | EURO piece | EURO piece | EURO piece | EURO piece |
|---------------|---------------|---------------|---------------|---------------|

PYRAMIDS & COLUMNS

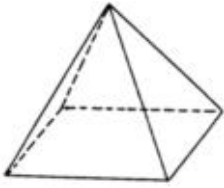

D.0479 - PYRAMID

BOX pieces

| <u>20 mm</u> | <u>25 mm</u> | <u>30 mm</u> | <u>40 mm</u> | <u>50 mm</u> |
|--------------|--------------|--------------|--------------|--------------|
| 40 | 40 | 40 | 10 | 10 |

| | | | | | |
|---------------|--------|--------|--------|--------|---------|
| CRYSTAL CLEAR | 1,1449 | 1,6097 | 1,8904 | 2,3580 | 3,7725 |
| CRYSTAL BB | 6,2663 | 6,8210 | 7,1911 | 8,1875 | 11,4055 |
| CRYSTAL VM | 6,2663 | 6,8210 | 7,1911 | 8,1875 | 11,4055 |

BOX pieces

| <u>60 mm</u> | <u>80 mm</u> | <u>100 mm</u> |
|--------------|--------------|---------------|
| 1 | 1 | 1 |

| | | | | | |
|---------------|---------|---------|---------|--|--|
| CRYSTAL CLEAR | 6,6020 | 14,6214 | 41,4984 | | |
| CRYSTAL BB | 16,0957 | 39,8097 | 72,4714 | | |
| CRYSTAL VM | 16,0957 | 39,8097 | 72,4714 | | |

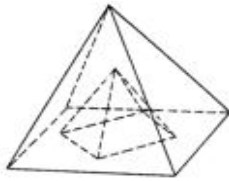

D.0489 - PYRAMID 2X

BOX pieces

| <u>80 mm</u> |
|--------------|
| 1 |

| | | | | | |
|---------------|---------|--|--|--|--|
| CRYSTAL CLEAR | 14,1436 | | | | |
| CRYSTAL BB | 33,7212 | | | | |
| CRYSTAL VM | 33,7212 | | | | |



D.0649 - COLUMN

BOX pieces

| <u>75x35 mm</u> | <u>100x35 mm</u> | <u>150x35 mm</u> |
|-----------------|------------------|------------------|
| 16 | 8 | 4 |

| | | | | | |
|---------------|--------|---------|---------|--|--|
| CRYSTAL CLEAR | 3,3301 | 5,4186 | 7,8324 | | |
| CRYSTAL BB | 8,9602 | 11,7572 | 15,2981 | | |
| CRYSTAL VM | 8,9602 | 11,7572 | 15,2981 | | |

BOX pieces

| <u>75x50 mm</u> | <u>100x50 mm</u> | <u>150x50 mm</u> |
|-----------------|------------------|------------------|
| 8 | 6 | 4 |

| | | | | | |
|---------------|---------|---------|---------|--|--|
| CRYSTAL CLEAR | 5,9426 | 8,9670 | 15,0331 | | |
| CRYSTAL BB | 13,8069 | 17,5573 | 24,5278 | | |
| CRYSTAL VM | 13,8069 | 17,5573 | 24,5278 | | |

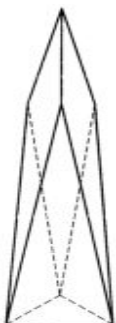

D.0650 - COLUMN

BOX pieces

| <u>60x33 mm</u> | <u>100x33mm</u> | <u>140x33mm</u> |
|-----------------|-----------------|-----------------|
| 16 | 12 | 16 |

| | | | | | |
|---------------|--------|--------|---------|--|--|
| CRYSTAL CLEAR | 2,8713 | 3,9949 | 6,9426 | | |
| CRYSTAL BB | 6,8522 | 9,8144 | 12,7622 | | |
| CRYSTAL VM | 6,8522 | 9,8144 | 12,7622 | | |

| | | | | |
|---------------|---------------|---------------|---------------|---------------|
| EURO piece | EURO piece | EURO piece | EURO piece | EURO piece |
|---------------|---------------|---------------|---------------|---------------|

CUBES & SLICES

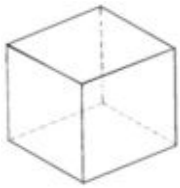

| | | | | | |
|-----------------------------|---------------------|---------------------|----------------------|---------------------|---------------------|
| <u>D.0546 - CUBE</u> | <u>20 mm</u> | <u>25 mm</u> | <u>30 mm</u> | <u>40 mm</u> | <u>50 mm</u> |
| BOX pieces | 50 | 20 | 20 | 10 | 10 |
| CRYSTAL CLEAR | 1,2754 | 1,9204 | 2,1337 | 2,9040 | 3,8928 |
| | <u>60 mm</u> | <u>80 mm</u> | <u>100 mm</u> | | |
| BOX pieces | 1 | 1 | 1 | | |
| CRYSTAL CLEAR | 6,7219 | 16,0632 | 37,3229 | | |

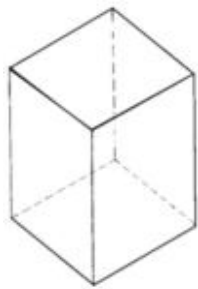

| | | | | | |
|-------------------------------|------------------------|------------------------|------------------------|------------------------|--------------------------|
| <u>D.0548 - CUBOID</u> | <u>40x40 mm</u> | <u>50x50 mm</u> | <u>60x60 mm</u> | <u>80x80 mm</u> | <u>100x100 mm</u> |
| height: | <u>60 mm</u> | <u>75 mm</u> | <u>90 mm</u> | <u>120 mm</u> | <u>150 mm</u> |
| BOX pieces | 12 | 8 | 5 | 1 | 1 |
| CRYSTAL CLEAR | 2,9348 | 5,1036 | 8,0691 | 44,2461 | 79,6196 |



| | |
|------------------------------------|--------------------------|
| <u>D.0542 - SLICE ROUND</u> | <u>100x100 mm</u> |
| height: | <u>20 mm</u> |
| BOX pieces | 1 |
| CRYSTAL CLEAR | 14,6412 |

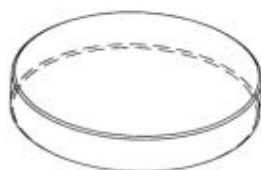

| | |
|-----------------------------------|-------------------------|
| <u>D.0544 - SLICE OVAL</u> | <u>100x76 mm</u> |
| height: | <u>20 mm</u> |
| BOX pieces | 1 |
| CRYSTAL CLEAR | 14,6412 |

EURO
piece

EURO
piece

EURO
piece

EURO
piece

EURO
piece

PAPERWEIGHTS

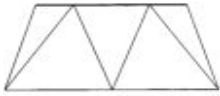

D.0630 - PAPERWEIGHT

75 mm

BOX pieces

1

CRYSTAL CLEAR

| 16,9410 |



D.0632 - PAPERWEIGHT

75 mm

BOX pieces

1

CRYSTAL CLEAR

| 17,7110 |



D.0634 - PAPERWEIGHT

75 mm

BOX pieces

1

CRYSTAL CLEAR

| 13,8664 |



D.0636 - PAPERWEIGHT

75 mm

BOX pieces

1

CRYSTAL CLEAR

| 15,0252 |

EURO
piece

EURO
piece

EURO
piece

EURO
piece

EURO
piece

WAVE & SHELL & MOUNTAIN & CASTLE

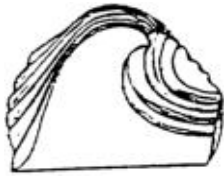

D.0665 - WAVE

BOX pieces

70 mm

1

CRYSTAL CLEAR
CRYSTAL BB
CRYSTAL VM

4,7269
17,0436
17,0436

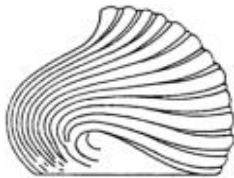

D.0668 - SHELL

BOX pieces

70 mm

1

CRYSTAL CLEAR
CRYSTAL BB
CRYSTAL VM

4,7269
17,0436
17,0436



D.0671 - MOUNTAIN

BOX pieces

55 mm

1

CRYSTAL CLEAR
CRYSTAL BB
CRYSTAL VM

14,4375
21,4373
21,4373

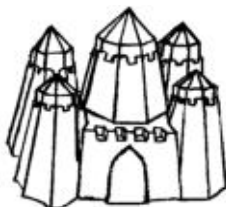

D.0675 - CASTLE

BOX pieces

70 mm

1

CRYSTAL CLEAR
CRYSTAL BB
CRYSTAL VM

35,9933
47,4531
47,4531

| | | | | |
|---------------|---------------|---------------|---------------|---------------|
| EURO piece | EURO piece | EURO piece | EURO piece | EURO piece |
|---------------|---------------|---------------|---------------|---------------|

DIAMONDS

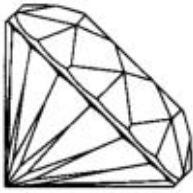

56 facets

| D.0623 - DIAMOND | 10 mm | 20 mm | 30 mm | 40 mm | 50 mm |
|-------------------------|--------------|--------------|--------------|--------------|--------------|
| BOX pieces | 320 | 150 | 60 | 28 | 12 |
| CRYSTAL CLEAR | 0,9994 | 1,3456 | 1,5770 | 2,1684 | 3,6389 |
| CRYSTAL FOILED | 1,1653 | 1,8543 | 2,4242 | 3,2331 | 5,3326 |
| CRYSTAL AB | 1,1653 | 1,8543 | 2,4242 | 3,2331 | 5,3326 |
| CRYSTAL AMBER | 1,1653 | 1,8543 | 2,4242 | 3,2331 | 5,3326 |
| CRYSTAL BB | 1,1653 | 1,8543 | 2,4242 | 3,2331 | 5,3326 |
| CRYSTAL VM | 1,1653 | 1,8543 | 2,4242 | 3,2331 | 5,3326 |
| ALEXANDRITE | 1,6539 | 2,7693 | 3,2694 | 4,9617 | 8,1542 |
| AQUAMARINE | 1,6539 | 2,7693 | 3,2694 | 4,9617 | 8,1542 |
| EMERALD | 1,6539 | 2,7693 | 3,2694 | 4,9617 | 8,1542 |
| ROSALIN | 1,6539 | 2,7693 | 3,2694 | 4,9617 | 8,1542 |
| RUBY | 1,6539 | 2,7693 | 3,2694 | 4,9617 | 8,1542 |
| SAPPHIRE | 1,6539 | 2,7693 | 3,2694 | 4,9617 | 8,1542 |
| TOPAZ | 1,6539 | 2,7693 | 3,2694 | 4,9617 | 8,1542 |

| | 60 mm | 80 mm | 100 mm |
|-------------------|--------------|--------------|---------------|
| BOX pieces | 1 | 1 | 1 |
| CRYSTAL CLEAR | 7,3014 | 16,7909 | 25,2929 |
| CRYSTAL FOILED | 9,7125 | 22,8533 | 35,0481 |
| CRYSTAL AB | 9,7125 | 22,8533 | 35,0481 |
| CRYSTAL AMBER | 9,7125 | 22,8533 | 35,0481 |
| CRYSTAL BB | 9,7125 | 22,8533 | 35,0481 |
| CRYSTAL VM | 9,7125 | 22,8533 | 35,0481 |
| ALEXANDRITE | 14,1929 | 31,6551 | 68,7719 |
| AQUAMARINE | 14,1929 | 31,6551 | 68,7719 |
| EMERALD | 14,1929 | 31,6551 | 68,7719 |
| ROSALIN | 14,1929 | 31,6551 | 68,7719 |
| RUBY | 14,1929 | 31,6551 | 68,7719 |
| SAPPHIRE | 14,1929 | 31,6551 | 68,7719 |
| TOPAZ | 14,1929 | 31,6551 | 68,7719 |

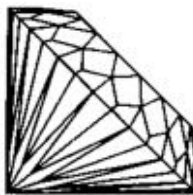

112 facets

| D.0624 - DIAMOND | 30 mm | 40 mm | 50 mm | 60 mm | 70 mm |
|-------------------------|--------------|--------------|--------------|--------------|--------------|
| BOX pieces | 60 | 28 | 12 | 1 | 1 |
| CRYSTAL CLEAR | 2,5039 | 3,0347 | 5,0964 | 8,5380 | 13,0539 |
| CRYSTAL FOILED | 3,3511 | 4,0995 | 6,7900 | 10,9491 | 17,4466 |
| CRYSTAL AB | 3,3511 | 4,0995 | 6,7900 | 10,9491 | 17,4466 |
| CRYSTAL AMBER | 3,3511 | 4,0995 | 6,7900 | 10,9491 | 17,4466 |
| CRYSTAL BB | 3,3511 | 4,0995 | 6,7900 | 10,9491 | 17,4466 |
| CRYSTAL VM | 3,3511 | 4,0995 | 6,7900 | 10,9491 | 17,4466 |

| | 100 mm | 150 mm | 200 mm |
|-------------------|---------------|---------------|---------------|
| BOX pieces | 1 | 1 | 1 |
| CRYSTAL CLEAR | 25,2929 | 90,5048 | 191,6648 |
| CRYSTAL FOILED | 35,0481 | 114,5514 | 243,9724 |
| CRYSTAL AB | 35,0481 | 114,5514 | 243,9724 |
| CRYSTAL AMBER | 35,0481 | 114,5514 | 243,9724 |
| CRYSTAL BB | 35,0481 | 114,5514 | 243,9724 |
| CRYSTAL VM | 35,0481 | 114,5514 | 243,9724 |

EURO
piece

EURO
piece

EURO
piece

EURO
piece

EURO
piece

GUARDIAN ANGELS



D.0602 - GUARDIAN ANGEL

BOX pieces

CRYSTAL CLEAR

120x70 mm 205x130 mm

1

1

| 17,4572 |

51,4826 |



D.0604 - GUARDIAN ANGEL

BOX pieces

CRYSTAL CLEAR

85x70 mm

1

| 3,6639 |

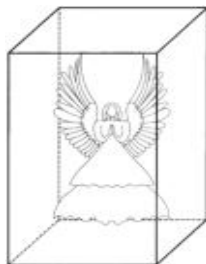

D.0610 - GUARDIAN ANGEL

height:

BOX pieces

CRYSTAL CLEAR

50x50 mm

80 mm

1

| 9,7539 |

EURO
piece

EURO
piece

EURO
piece

EURO
piece

EURO
piece

HEARTS

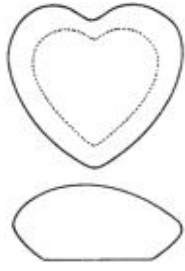

D.1221 - HEART

BOX pieces

75 mm

1

CRYSTAL CLEAR
RUBY

16,1490
19,0090

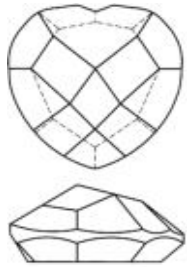

D.1222 - HEART

BOX pieces

70 mm

1

CRYSTAL CLEAR
RUBY

18,9608
25,0028



D.1225 - HEART PENDANT

BAG pieces

45 mm

1

(individually packed in poly-bag)

CRYSTAL CLEAR
CRYSTAL AB
ROSALIN
ROSALIN AB

1,2904
2,6513
2,1936
3,5546



D.1226 - HEART PENDANT

BAG pieces

40 mm

1

(individually packed in poly-bag)

CRYSTAL CLEAR
CRYSTAL AB

4,1254
5,0255

EURO
piece

EURO
piece

EURO
piece

EURO
piece

EURO
piece

ROSES



D.1220 - ROSE

250 mm

BOX pieces

1

RUBY / EMERALD / CLEAR |

14,7993 |



D.1224 - ROSE

75 mm

BOX pieces

1

RUBY / EMERALD / CLEAR |

5,4471 |

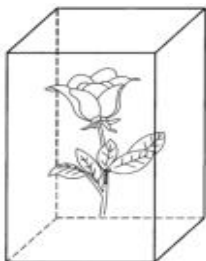

D.1228 - ROSE

50x50 mm

height:

80 mm

BOX pieces

1

CRYSTAL CLEAR |

9,7539 |

EURO
piece

EURO
piece

EURO
piece

EURO
piece

EURO
piece

CRYSTAL CLEAR

CRYSTAL PLATINUM

CRYSTAL GOLD



D.0810



D.0811



D.0812

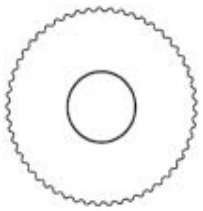

D.0820



D.0821



D.0822

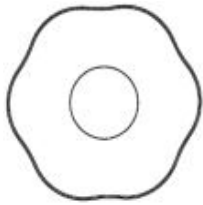

D.0830

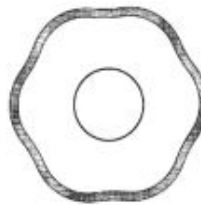

D.0831



D.0832

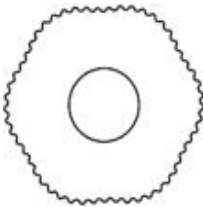

D.0840

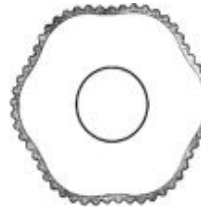

D.0841

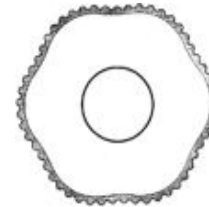

D.0842



D.0850

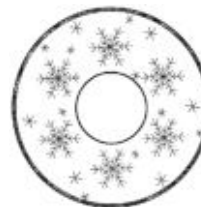

D.0851

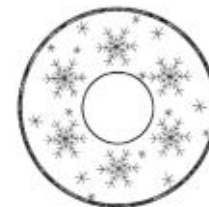

D.0852

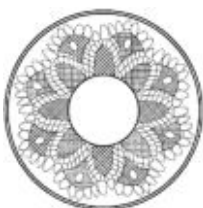

D.0860

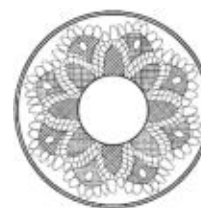

D.0861

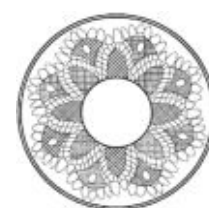

D.0862

EURO
pieceEURO
pieceEURO
pieceEURO
pieceEURO
piece

CANDLERINGS

CANDLERING

70 mm

center-hole: 25mm

BAG pieces

1

(individually packed in poly-bag)

per hole :

D.0810
D.0811
D.0812CRYSTAL - CLEAR rim
CRYSTAL - PLATINUM rim
CRYSTAL - GOLD rim2,1347
4,3129
4,3129

| | |
|---------------------------------|--------|
| drilling of small side-hole : | 0,2685 |
| stud-insertion into side-hole : | |
| BRASS | 0,0619 |
| CHROME-PLATED | 0,0626 |
| GOLD-PLATED | 0,0787 |

CANDLERING

70 mm

center-hole: 25mm

BAG pieces

1

(individually packed in poly-bag)

per hole :

D.0820
D.0821
D.0822CRYSTAL - CLEAR rim
CRYSTAL - PLATINUM rim
CRYSTAL - GOLD rim2,6547
4,3129
4,3129

| | |
|---------------------------------|--------|
| drilling of small side-hole : | 0,2685 |
| stud-insertion into side-hole : | |
| BRASS | 0,0619 |
| CHROME-PLATED | 0,0626 |
| GOLD-PLATED | 0,0787 |

CANDLERING

70 mm

center-hole: 25mm

BAG pieces

1

(individually packed in poly-bag)

per hole :

D.0830
D.0831
D.0832CRYSTAL - CLEAR rim
CRYSTAL - PLATINUM rim
CRYSTAL - GOLD rim2,5230
4,3129
4,3129

| | |
|---------------------------------|--------|
| drilling of small side-hole : | 0,2685 |
| stud-insertion into side-hole : | |
| BRASS | 0,0619 |
| CHROME-PLATED | 0,0626 |
| GOLD-PLATED | 0,0787 |

CANDLERING

70 mm

center-hole: 25mm

BAG pieces

1

(individually packed in poly-bag)

per hole :

D.0840
D.0841
D.0842CRYSTAL - CLEAR rim
CRYSTAL - PLATINUM rim
CRYSTAL - GOLD rim3,1748
4,3129
4,3129

| | |
|---------------------------------|--------|
| drilling of small side-hole : | 0,2685 |
| stud-insertion into side-hole : | |
| BRASS | 0,0619 |
| CHROME-PLATED | 0,0626 |
| GOLD-PLATED | 0,0787 |

CANDLERING

70 mm

center-hole: 25mm

BAG pieces

1

(individually packed in poly-bag)

per hole :

D.0850
D.0851
D.0852CRYSTAL - CLEAR rim
CRYSTAL - PLATINUM rim
CRYSTAL - GOLD rim3,1379
4,3129
4,3129

| | |
|---------------------------------|--------|
| drilling of small side-hole : | 0,2685 |
| stud-insertion into side-hole : | |
| BRASS | 0,0619 |
| CHROME-PLATED | 0,0626 |
| GOLD-PLATED | 0,0787 |

CANDLERING

70 mm

center-hole: 25mm

BAG pieces

1

(individually packed in poly-bag)

per hole :

D.0860
D.0861
D.0862CRYSTAL - CLEAR rim
CRYSTAL - PLATINUM rim
CRYSTAL - GOLD rim3,1379
4,3129
4,3129

| | |
|---------------------------------|--------|
| drilling of small side-hole : | 0,2685 |
| stud-insertion into side-hole : | |
| BRASS | 0,0619 |
| CHROME-PLATED | 0,0626 |
| GOLD-PLATED | 0,0787 |

EURO
pieceEURO
pieceEURO
pieceEURO
pieceEURO
piece

SPECIALITIES ... FENGSHUI



D.1330 - DOLPHIN

28 mm

BAG pieces

1

(individually packed in poly-bag)

CRYSTAL CLEAR
CRYSTAL AB7,5440
7,9798

D.1340 - DOLPHIN

30 mm60 mm

BAG pieces

1

1

(individually packed in poly-bag)

CRYSTAL CLEAR
CRYSTAL AB2,0430
2,65433,2035
4,7571

(suspension: chrome)



D.1350 - CENTERING

60 mm90 mm

BOX pieces

1

1

(individually packed in white box)

CRYSTAL CLEAR
CRYSTAL AB11,3175
11,630113,3499
15,0859

(suspension: chrome)

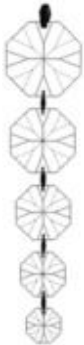

D.1353 - OCTAGONCHAIN

140 mm

BAG pieces

1

(individually packed in poly-bag)

CRYSTAL CLEAR
CRYSTAL AB3,7293
5,8990

(suspension & pinning-material: chrome)

(octagons: 30mm+26mm+22mm+18mm+14mm)



D.2600 - HEMISPHERE

20 mm30 mm40 mm50 mm60 mm

BAG pieces

1

1

1

1

1

CRYSTAL FOILED

5,7831

7,5969

8,9282

15,1713

31,1752

(inclusive two-sided self-adhesive sticker 18mm)

(1x)

(1x)

(1x)

(1x)

(1x)



D.2602 - MIRROR

25x25 mm38x38 mm50x50 mm63x63 mm76x76 mm

BOX pieces

100

70

70

50

50

CRYSTAL FOILED

1,1488

1,4770

2,1130

2,3667

2,4963

(inclusive two-sided self-adhesive sticker 18mm)

(1x)

(1x)

(1x)

(1x)

(1x)

BOX pieces

50

50

20

15

15

CRYSTAL FOILED

2,6257

3,4463

4,5950

5,5797

7,8772

(inclusive two-sided self-adhesive sticker 18mm)

(2x)

(3x)

(4x)

(5x)

(6x)

EURO
piece

EURO
piece

EURO
piece

EURO
piece

EURO
piece

SUNCATCHERS ... FENGSHUI



D.2603 - DOLPHIN

BAG pieces

63x63 mm

1 (individually packed in poly-bag)

CRYSTAL AB

| 16,2847 |

(suspension: chrome)



D.2604 - YIN YANG

BAG pieces

63x63 mm

1 (individually packed in poly-bag)

CRYSTAL AB

| 16,2847 |

(suspension: chrome)



D.2605 - CENTERMIRROR

BAG pieces

63x63 mm

1 (individually packed in poly-bag)

CRYSTAL AB

| 16,2847 |

(suspension: chrome)



D.2606 - SUN

BAG pieces

63x63 mm

1 (individually packed in poly-bag)

CRYSTAL AB

| 16,2847 |

(suspension: chrome)



D.2607 - MOON

BAG pieces

63x63 mm

1 (individually packed in poly-bag)

CRYSTAL AB

| 16,2847 |

(suspension: chrome)



D.2608 - STAR

BAG pieces

63x63 mm

1 (individually packed in poly-bag)

CRYSTAL AB

| 16,2847 |

(suspension: chrome)

EURO
pieceEURO
pieceEURO
pieceEURO
pieceEURO
piece

SPIRITUAL ... PENDANTS



D.1170 - PENDULUM

50 mm

BOX pieces

1

CRYSTAL CLEAR

4,3216



D.1175 - PENTAGRAM

50 mm

BOX pieces

1

CRYSTAL CLEAR

4,3216



D.1180 - MERKABA

50 mm

BOX pieces

1

CRYSTAL CLEAR

13,8164



D.1185 - SPIRAL

50 mm

BOX pieces

1

CRYSTAL CLEAR

8,9926



D.1190 - ENERGYRING

50 mm

BOX pieces

1

CRYSTAL CLEAR

6,4099

CRYSTAL AB

9,4820



D.1193 - STARRING

50 mm

BOX pieces

1

CRYSTAL CLEAR

12,3880

CRYSTAL AB

13,6131

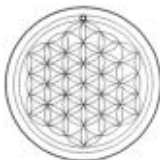

D.1195 - FLOWER OF LIFE

50 mm

BOX pieces

1

CRYSTAL CLEAR

13,4169

CRYSTAL AB

14,8668

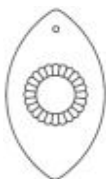

D.1197 - SHIVA'S EYE

43 mm

BOX pieces

1

CRYSTAL CLEAR

4,6707

CRYSTAL AB

5,3224

CRYSTAL BB

5,3224

CRYSTAL VM

5,3224

EURO
pieceEURO
pieceEURO
pieceEURO
pieceEURO
piece**MOTIF ... PENDANTS****D.1101 - ANGEL**

BAG pieces (individually packed in poly-bag)

35 mm **50 mm** **65 mm**

1 1 1

CRYSTAL CLEAR
CRYSTAL AB

| | | |
|--------|--------|---------|
| 3,2331 | 4,8117 | 6,9718 |
| 4,4197 | 7,1140 | 11,1073 |

**D.1102 - BUTTERFLY**

BAG pieces (individually packed in poly-bag)

35 mm **50 mm** **65 mm**

1 1 1

CRYSTAL CLEAR
CRYSTAL AB

| | | |
|--------|--------|---------|
| 3,2331 | 4,8117 | 6,9718 |
| 4,4197 | 7,1140 | 11,1073 |

**D.1103 - DOLPHIN**

BAG pieces (individually packed in poly-bag)

35 mm **50 mm** **65 mm**

1 1 1

CRYSTAL CLEAR
CRYSTAL AB

| | | |
|--------|--------|---------|
| 3,2331 | 4,8117 | 6,9718 |
| 4,4197 | 7,1140 | 11,1073 |

**D.1104 - DRAGON**

BAG pieces (individually packed in poly-bag)

35 mm **50 mm** **65 mm**

1 1 1

CRYSTAL CLEAR
CRYSTAL AB

| | | |
|--------|--------|---------|
| 3,2331 | 4,8117 | 6,9718 |
| 4,4197 | 7,1140 | 11,1073 |

**D.1105 - HORSE**

BAG pieces (individually packed in poly-bag)

35 mm **50 mm** **65 mm**

1 1 1

CRYSTAL CLEAR
CRYSTAL AB

| | | |
|--------|--------|---------|
| 3,2331 | 4,8117 | 6,9718 |
| 4,4197 | 7,1140 | 11,1073 |

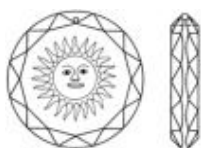
**D.1106 - SUN**

BAG pieces (individually packed in poly-bag)

35 mm **50 mm** **65 mm**

1 1 1

CRYSTAL CLEAR
CRYSTAL AB

| | | |
|--------|--------|---------|
| 3,2331 | 4,8117 | 6,9718 |
| 4,4197 | 7,1140 | 11,1073 |

**D.1107 - MOON**

BAG pieces (individually packed in poly-bag)

35 mm **50 mm** **65 mm**

1 1 1

CRYSTAL CLEAR
CRYSTAL AB

| | | |
|--------|--------|---------|
| 3,2331 | 4,8117 | 6,9718 |
| 4,4197 | 7,1140 | 11,1073 |

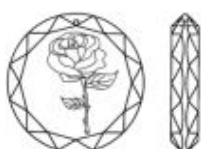
**D.1108 - ROSE**

BAG pieces (individually packed in poly-bag)

35 mm **50 mm** **65 mm**

1 1 1

CRYSTAL CLEAR
CRYSTAL AB

| | | |
|--------|--------|---------|
| 3,2331 | 4,8117 | 6,9718 |
| 4,4197 | 7,1140 | 11,1073 |

EURO
piece

EURO
piece

EURO
piece

EURO
piece

EURO
piece

ANGEL I ... PENDANTS



D.1166 - ANGEL

BOX pieces

35 mm
50

55 mm
25

(individually packed in poly-bag)

CRYSTAL CLEAR
CRYSTAL AB
CRYSTAL SILVER
CRYSTAL GOLD

1,5430
3,1155
3,1155
3,1155

5,4381
7,3705
7,3705
7,3705



D.1177 - ANGEL

BOX pieces

55 mm
25

70 mm
15

(individually packed in poly-bag)

CRYSTAL CLEAR
CRYSTAL AB
CRYSTAL SILVER
CRYSTAL GOLD

4,0870
5,9560
5,9560
5,9560

6,5198
10,2585
10,2585
10,2585



D.1188 - ANGEL

BOX pieces

50 mm
25

75 mm
15

(individually packed in poly-bag)

CRYSTAL CLEAR
CRYSTAL AB
CRYSTAL SILVER
CRYSTAL GOLD

4,1015
6,8459
6,8459
6,8459

7,4565
12,3869
12,3869
12,3869



D.1199 - ANGEL

BOX pieces

45 mm
25

60 mm
15

(individually packed in poly-bag)

CRYSTAL CLEAR
CRYSTAL AB
CRYSTAL SILVER
CRYSTAL GOLD

4,5999
6,9535
6,9535
6,9535

7,3288
11,5409
11,5409
11,5409

EURO
piece

EURO
piece

EURO
piece

EURO
piece

EURO
piece

ANGEL II ... PENDANTS



D.1187 - ANGEL

50 mm

BOX pieces

25

(individually packed in poly-bag)

CRYSTAL CLEAR
CRYSTAL AB
CRYSTAL OG
CRYSTAL OS

4,7303
6,5681
6,5681
6,5681

(suspension: chrome)

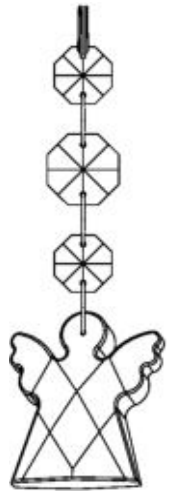

D.1189 - ANGEL

135 mm

BOX pieces

25

(individually packed in poly-bag)

CRYSTAL CLEAR
CRYSTAL AB
CRYSTAL OG
CRYSTAL OS

8,6844
12,4351
12,4351
12,4351

(suspension & pinning-material: chrome)

(octagons: 16mm+20mm+16mm)



D.1258 - ANGEL

35 mm

50 mm

BOX pieces

50

25

(individually packed in poly-bag)

CRYSTAL CLEAR
CRYSTAL AB
CRYSTAL OG
CRYSTAL OS

1,8681
2,7879
2,7879
2,7879

2,5744
5,3013
5,3013
5,3013

(suspension: chrome)



D.1259 - ANGEL

110 mm

135 mm

BOX pieces

50

25

(individually packed in poly-bag)

CRYSTAL CLEAR
CRYSTAL AB
CRYSTAL OG
CRYSTAL OS

2,3733
3,8776
3,8776
3,8776

3,2771
6,7074
6,7074
6,7074

(suspension & pinning-material: chrome)

(small angel ... octagons: 14mm+18mm+14mm)

(large angel ... octagons: 16mm+20mm+16mm)

EURO
piece

EURO
piece

EURO
piece

EURO
piece

EURO
piece

SKY I ... PENDANTS



D.1263 - SUN

BAG pieces

28 mm

1 (individually packed in poly-bag)

CRYSTAL CLEAR
CRYSTAL AB
CRYSTAL AMBER

7,5440
7,9798
7,9798



D.1283 - MOON

BAG pieces

28 mm

1 (individually packed in poly-bag)

CRYSTAL CLEAR
CRYSTAL AB
CRYSTAL AMBER

7,5440
7,9798
7,9798



D.1293 - STAR

BAG pieces

28 mm

1 (individually packed in poly-bag)

CRYSTAL CLEAR
CRYSTAL AB
CRYSTAL AMBER

7,5440
7,9798
7,9798

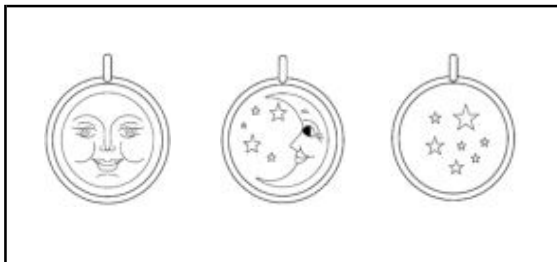

D. 1263 / 1283 / 1293 - SET (in box) ... 1 piece of each motif :

CRYSTAL CLEAR
CRYSTAL AB
CRYSTAL AMBER

22,6321
23,9393
23,9393

EURO
piece

EURO
piece

EURO
piece

EURO
piece

EURO
piece

SKY II ... PENDANTS



D.1264 - SUN

BOX pieces

30 mm
50

50 mm
20

(individually packed in poly-bag)

CRYSTAL CLEAR
CRYSTAL AB
CRYSTAL AMBER

5,1622
5,6189
5,6189

7,6669
9,7475
9,7475

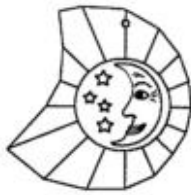

D.1284 - MOON

BOX pieces

50 mm
20

(individually packed in poly-bag)

CRYSTAL CLEAR
CRYSTAL AB
CRYSTAL AMBER

7,6669
9,7475
9,7475

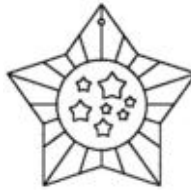

D.1294 - STAR

BOX pieces

50 mm
20

(individually packed in poly-bag)

CRYSTAL CLEAR
CRYSTAL AB
CRYSTAL AMBER

7,6669
9,7475
9,7475

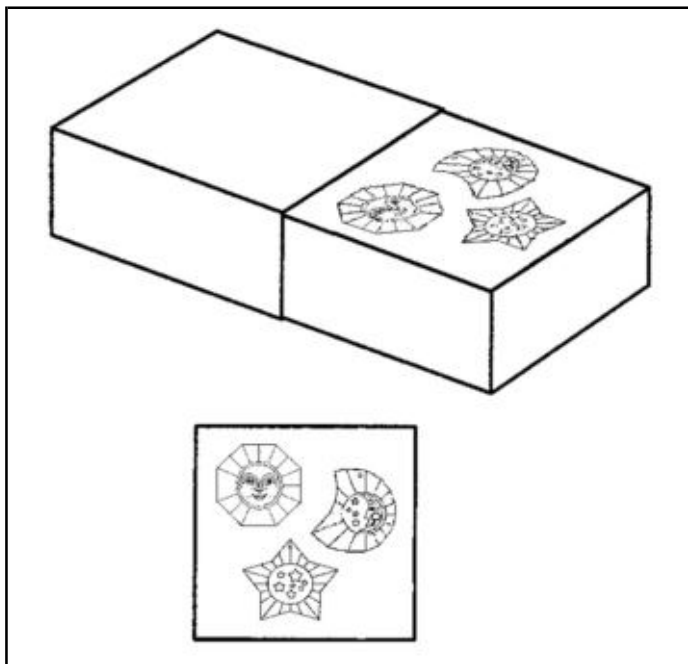

D. 1264 / 1284 / 1294 - SET (in special foam)

... 1 piece of each motif of size 50mm :

CRYSTAL CLEAR
CRYSTAL AB
CRYSTAL AMBER

23,0006
29,2425
29,2425

EURO
piece

EURO
piece

EURO
piece

EURO
piece

EURO
piece

FLOWER ... PENDANTS

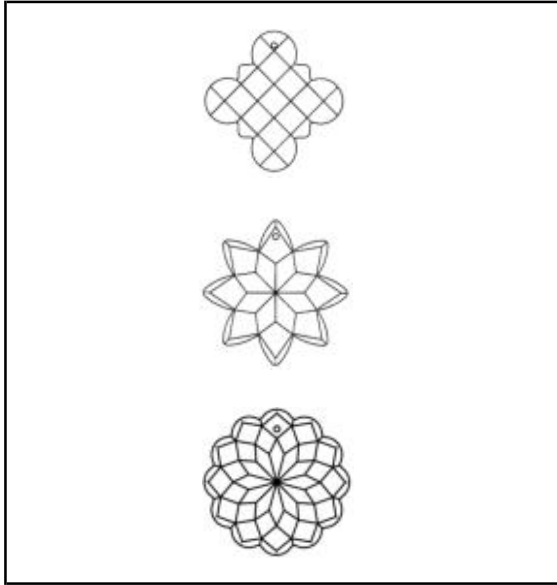

D.3291/3293/3295 - FLOWER-SET

BOX pieces 3

| | |
|---------------|---------|
| CRYSTAL CLEAR | 6,0956 |
| CRYSTAL AB | 11,4877 |
| CRYSTAL AMBER | 11,4877 |

(size of each article: 50 mm)

(contains 1 of each article)



D.1760 - BLOSSOM

BOX pieces

76x19 mm 100x25 mm

56

30

| | | |
|---------------|--------|--------|
| CRYSTAL CLEAR | 2,9466 | 5,5088 |
| CRYSTAL AB | 5,6735 | 8,2357 |
| CRYSTAL AMBER | 5,6735 | 8,2357 |

EURO
piece

EURO
piece

EURO
piece

EURO
piece

EURO
piece

BUTTERFLY ... PENDANTS

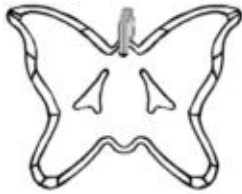

D.1217 - BUTTERFLY

BAG pieces

25 mm

50 mm

1

1

(individually packed in poly-bag)

CRYSTAL CLEAR

2,3480

3,7325

CRYSTAL AB

2,8426

5,0998

ALEXANDRITE

4,3055

7,3517

AMETHYST

4,3055

7,3517

AQUAMARINE

4,3055

7,3517

EMERALD

4,3055

7,3517

JET

4,3055

7,3517

ROSALIN

4,3055

7,3517

RUBY

4,3055

7,3517

SAPPHIRE

4,3055

7,3517

SMOKE

4,3055

7,3517

TOPAZ

4,3055

7,3517

(suspension: chrome)

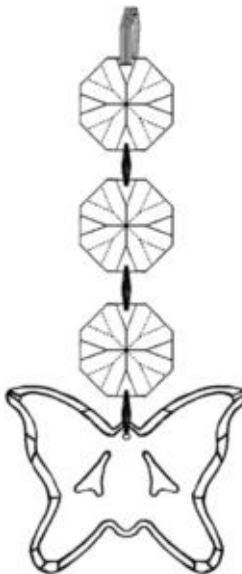

D.1218 - BUTTERFLY

BAG pieces

75 mm

105 mm

1

1

(individually packed in poly-bag)

CRYSTAL CLEAR

2,6935

4,2913

CRYSTAL AB

3,1881

5,6585

ALEXANDRITE

4,6511

7,9105

AMETHYST

4,6511

7,9105

AQUAMARINE

4,6511

7,9105

EMERALD

4,6511

7,9105

JET

4,6511

7,9105

ROSALIN

4,6511

7,9105

RUBY

4,6511

7,9105

SAPPHIRE

4,6511

7,9105

SMOKE

4,6511

7,9105

TOPAZ

4,6511

7,9105

(suspension & pinning-material: chrome)

octagons (CRYSTAL CLEAR) :

12 mm

16 mm

EURO
pieceEURO
pieceEURO
pieceEURO
pieceEURO
piece

CHRISTMAS I ... PENDANTS



D.3927 - STAR

43 mm

BOX pieces

20

(individually packed in poly-bag)

| | | | | |
|-----------------|--------|--|--|--|
| CRYSTAL CLEAR | 4,0478 | | | |
| CRYSTAL AB | 5,7297 | | | |
| CRYSTAL AFLAME | 5,7297 | | | |
| CRYSTAL AMBER | 5,7297 | | | |
| CRYSTAL ANTIQUE | 5,7297 | | | |
| CRYSTAL GOLD | 5,7297 | | | |
| CRYSTAL SILVER | 5,7297 | | | |
| CRYSTAL BB | 5,7297 | | | |
| CRYSTAL BW | 5,7297 | | | |
| CRYSTAL OG | 5,7297 | | | |
| CRYSTAL OS | 5,7297 | | | |
| CRYSTAL VL | 5,7297 | | | |
| CRYSTAL VM | 5,7297 | | | |
| ALEXANDRITE | 5,7297 | | | |
| AMETHYST | 5,7297 | | | |
| AQUAMARINE | 5,7297 | | | |
| EMERALD | 5,7297 | | | |
| JET | 5,7297 | | | |
| RODALIN | 5,7297 | | | |
| RUBY | 5,7297 | | | |
| SAPPHIRE | 5,7297 | | | |
| SMOKE | 5,7297 | | | |
| TOPAZ | 5,7297 | | | |

(suspension: plastic (black) & metal (chrome))



D.3929 - TREE

50 mm
63 mm
76 mm

BOX pieces

20

20

20

(individually packed in poly-bag)

| | | | |
|---------------|--------|--------|--------|
| CRYSTAL CLEAR | 2,6294 | 2,7880 | 3,6658 |
| CRYSTAL AB | 3,9340 | 4,4699 | 6,3339 |



D.1900 - DECORATIVE HANGER

70 mm

BOX pieces

24

(individually packed in poly-bag)

| | | | |
|------------------------|--------|--|--|
| CHROME / CRYSTAL CLEAR | 5,0836 | | |
|------------------------|--------|--|--|

(especially suitable for hanging CHRISTMAS PENDANTS at the lower end)

EURO
piece

EURO
piece

EURO
piece

EURO
piece

EURO
piece

CHRISTMAS II ... PENDANTS



D.1250 - ANGEL

70 mm

BOX pieces

20

(individually packed in poly-bag)

CRYSTAL CLEAR
CRYSTAL AB
CRYSTAL OG
CRYSTAL OS

3,4990
6,2281
6,2281
6,2281



D.1251 - SNOWMAN

65 mm

BOX pieces

20

(individually packed in poly-bag)

CRYSTAL CLEAR
CRYSTAL AB
CRYSTAL OG
CRYSTAL OS

3,4990
6,2281
6,2281
6,2281



D.1252 - TEDDYBEAR

50 mm

BOX pieces

20

(individually packed in poly-bag)

CRYSTAL CLEAR
CRYSTAL AB
CRYSTAL OG
CRYSTAL OS

3,4990
6,2281
6,2281
6,2281



D.1254 - CHRISTMASLEIG

60 mm

BOX pieces

20

(individually packed in poly-bag)

CRYSTAL CLEAR
CRYSTAL AB
CRYSTAL OG
CRYSTAL OS

3,4990
6,2281
6,2281
6,2281



D.1255 - REINDEER

50 mm

BOX pieces

20

(individually packed in poly-bag)

CRYSTAL CLEAR
CRYSTAL AB
CRYSTAL OG
CRYSTAL OS

3,4990
6,2281
6,2281
6,2281



D.1256 - ROCKINGHORSE

60 mm

BOX pieces

20

(individually packed in poly-bag)

CRYSTAL CLEAR
CRYSTAL AB
CRYSTAL OG
CRYSTAL OS

3,4990
6,2281
6,2281
6,2281

| | | | | |
|---------------|---------------|---------------|---------------|---------------|
| EURO piece | EURO piece | EURO piece | EURO piece | EURO piece |
|---------------|---------------|---------------|---------------|---------------|

CLUSTER I ... PENDANTS



D.1600 - CLUSTER

BOX pieces

| | | | | |
|--------------|--------------|--------------|---------------|---------------|
| <u>30 mm</u> | <u>60 mm</u> | <u>90 mm</u> | <u>120 mm</u> | <u>150 mm</u> |
| 64 | 32 | 24 | 16 | 16 |

| | | | | | |
|------------------|-------------|-------------|-------------|-------------|-------------|
| CRYSTAL CLEAR | 1,1060 | 2,2120 | 3,3180 | 4,4240 | 5,5300 |
| CRYSTAL AB | 2,4491 | 4,8983 | 7,3474 | 9,7965 | 12,2456 |
| (octagons: 14mm) | (10 pieces) | (20 pieces) | (30 pieces) | (40 pieces) | (50 pieces) |



BOX pieces

| | | | | |
|---------------|---------------|---------------|---------------|---------------|
| <u>180 mm</u> | <u>210 mm</u> | <u>240 mm</u> | <u>270 mm</u> | <u>300 mm</u> |
| 8 | 8 | 8 | 8 | 8 |

| | | | | | |
|------------------|-------------|-------------|-------------|-------------|--------------|
| CRYSTAL CLEAR | 6,6360 | 7,7420 | 8,8480 | 9,9540 | 11,0600 |
| CRYSTAL AB | 14,6948 | 17,1439 | 19,5930 | 22,0421 | 24,4913 |
| (octagons: 14mm) | (60 pieces) | (70 pieces) | (80 pieces) | (90 pieces) | (100 pieces) |

NOTE :

We can greatly customize your cluster through pinning a crystal at the lower end !
Select a CLEAR or COATED or COLORED finial for your cluster to make it really unique !



D.1610 - CLUSTER

BOX pieces

| |
|--------------|
| <u>40 mm</u> |
| 16 |

| | | | | | |
|------------------|-------------|--|--|--|--|
| CRYSTAL CLEAR | 2,7689 | | | | |
| CRYSTAL AB | 5,2714 | | | | |
| (octagons: 20mm) | (10 pieces) | | | | |



BOX pieces

| |
|--------------|
| <u>80 mm</u> |
| 10 |

| | | | | | |
|------------------|-------------|--|--|--|--|
| CRYSTAL CLEAR | 5,5379 | | | | |
| CRYSTAL AB | 10,5429 | | | | |
| (octagons: 20mm) | (20 pieces) | | | | |

NOTE :

We can greatly customize your cluster through pinning a crystal at the lower end !
Select a CLEAR or COATED or COLORED finial for your cluster to make it really unique !



D.1620 - CLUSTER

BOX pieces

| |
|--------------|
| <u>70 mm</u> |
| 10 |

| | | | | | |
|-------------------------|-------------------------|--|--|--|--|
| CRYSTAL CLEAR | 3,8749 | | | | |
| CRYSTAL AB | 7,7206 | | | | |
| (octagons: 20mm & 14mm) | (10 pieces & 10 pieces) | | | | |



BOX pieces

| |
|---------------|
| <u>140 mm</u> |
| 6 |

| | | | | | |
|-------------------------|-------------------------|--|--|--|--|
| CRYSTAL CLEAR | 7,7499 | | | | |
| CRYSTAL AB | 15,4411 | | | | |
| (octagons: 20mm & 14mm) | (20 pieces & 20 pieces) | | | | |

NOTE :

We can greatly customize your cluster through pinning a crystal at the lower end !
Select a CLEAR or COATED or COLORED finial for your cluster to make it really unique !

| | | | | |
|---------------|---------------|---------------|---------------|---------------|
| EURO piece | EURO piece | EURO piece | EURO piece | EURO piece |
|---------------|---------------|---------------|---------------|---------------|

CLUSTER II ... PENDANTS

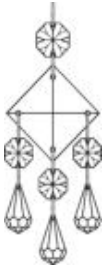

D.1721 - RAINBOW CLUSTER

BOX pieces

100 mm (individually packed)
25 (in poly-bag)

CRYSTAL CLEAR
CRYSTAL AB

| | | | |
|--------|--|--|--|
| 2,6405 | | | |
| 4,3538 | | | |



D.1722 - RAINBOW CLUSTER

BOX pieces

100 mm (individually packed)
25 (in poly-bag)

CRYSTAL CLEAR
CRYSTAL AB

| | | | |
|--------|--|--|--|
| 2,7344 | | | |
| 4,5277 | | | |



D.1730 - DROP CLUSTER

BOX pieces

50 mm 70 mm (individually packed)
24 15 (in poly-bag)

CRYSTAL CLEAR
CRYSTAL AB

| | | | |
|--------|--------|--|--|
| 3,5193 | 3,8198 | | |
| 5,6523 | 7,1241 | | |



D.1731 - HEART CLUSTER

BOX pieces

40 mm 60 mm (individually packed)
24 15 (in poly-bag)

CRYSTAL CLEAR
CRYSTAL AB

| | | | |
|--------|--------|--|--|
| 3,4226 | 3,8718 | | |
| 5,5858 | 7,3676 | | |



D.1732 - SUN CLUSTER

BOX pieces

55 mm 65 mm (individually packed)
24 15 (in poly-bag)

CRYSTAL CLEAR
CRYSTAL AB

| | | | |
|---------|---------|--|--|
| 5,2672 | 5,1345 | | |
| 10,5997 | 11,0246 | | |



D.1740 - SPIRAL CLUSTER

BOX pieces

110x70 mm (individually packed)
5 (in plastic-bag)

CRYSTAL CLEAR
CRYSTAL AB

| | | | |
|---------|--|--|--|
| 10,1923 | | | |
| 17,4495 | | | |

NOTE :

We can greatly customize your spiral through pinning a crystal at the lower end !
Select a CLEAR or COATED or COLORED finial for your cluster to make it really unique !

| | | | | |
|---------------|---------------|---------------|---------------|---------------|
| EURO piece | EURO piece | EURO piece | EURO piece | EURO piece |
|---------------|---------------|---------------|---------------|---------------|

STAR I ... PENDANTS

D.1752 - STAR

BAG pieces

70 mm
1

90 mm
1

130 mm
1

180 mm
1

(individually packed)
(in plastic-bag)

CRYSTAL CLEAR
CRYSTAL AB

6,1289
12,4409

7,9926
14,3766

12,7997
21,3117

20,6410
31,2810

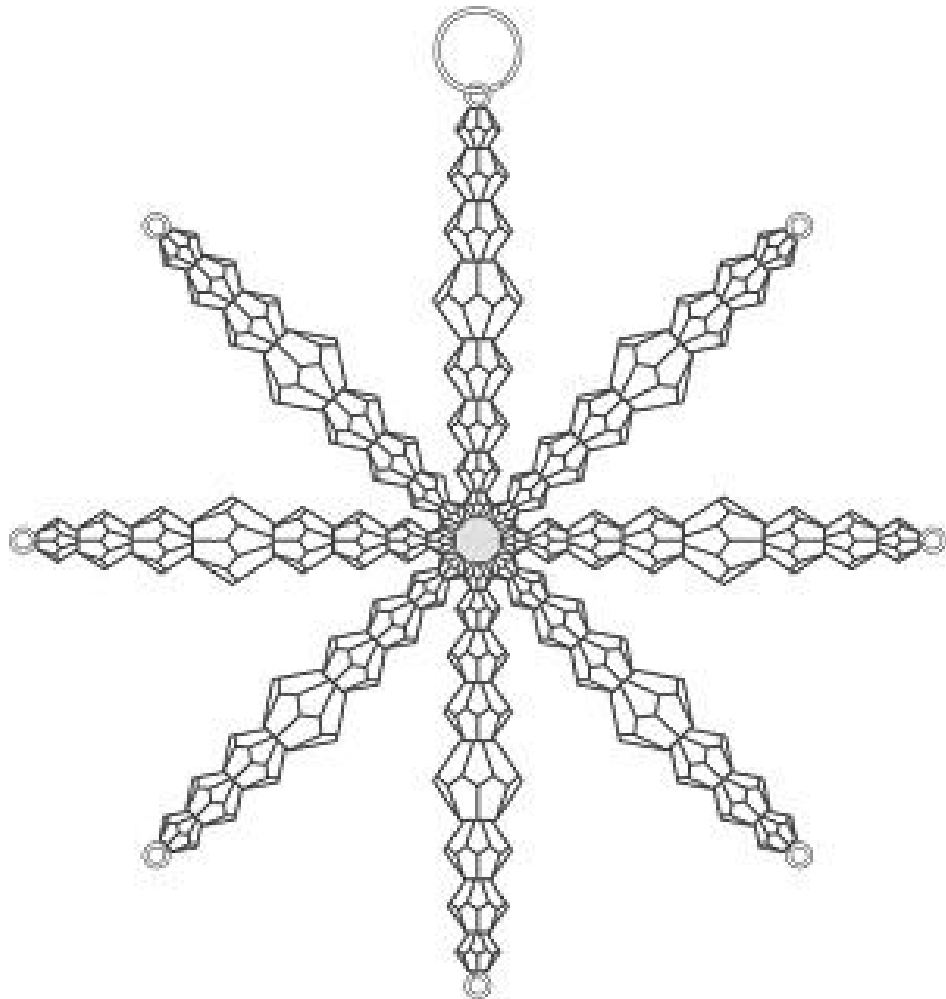

| | | | | |
|---------------|---------------|---------------|---------------|---------------|
| EURO piece | EURO piece | EURO piece | EURO piece | EURO piece |
|---------------|---------------|---------------|---------------|---------------|

STAR II ... PENDANTS

D.1753 - STAR

BAG pieces

70 mm
1

90 mm
1

130 mm
1

180 mm
1

(individually packed)
(in plastic-bag)

CRYSTAL CLEAR
CRYSTAL AB

6,1289
12,4409

7,9926
14,3766

12,7997
21,3117

20,6410
31,2810

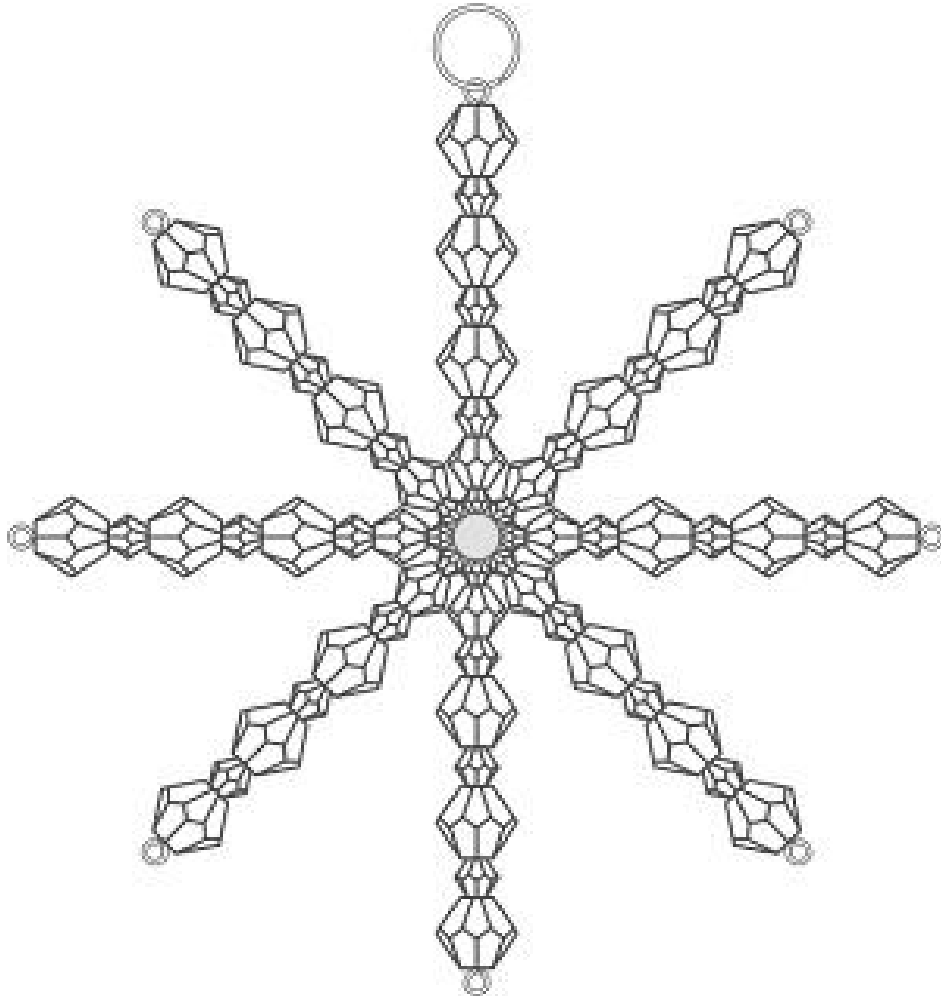

EURO
piece

EURO
piece

EURO
piece

EURO
piece

EURO
piece

**UPPER
PART**

CASCADE ... PENDANTS

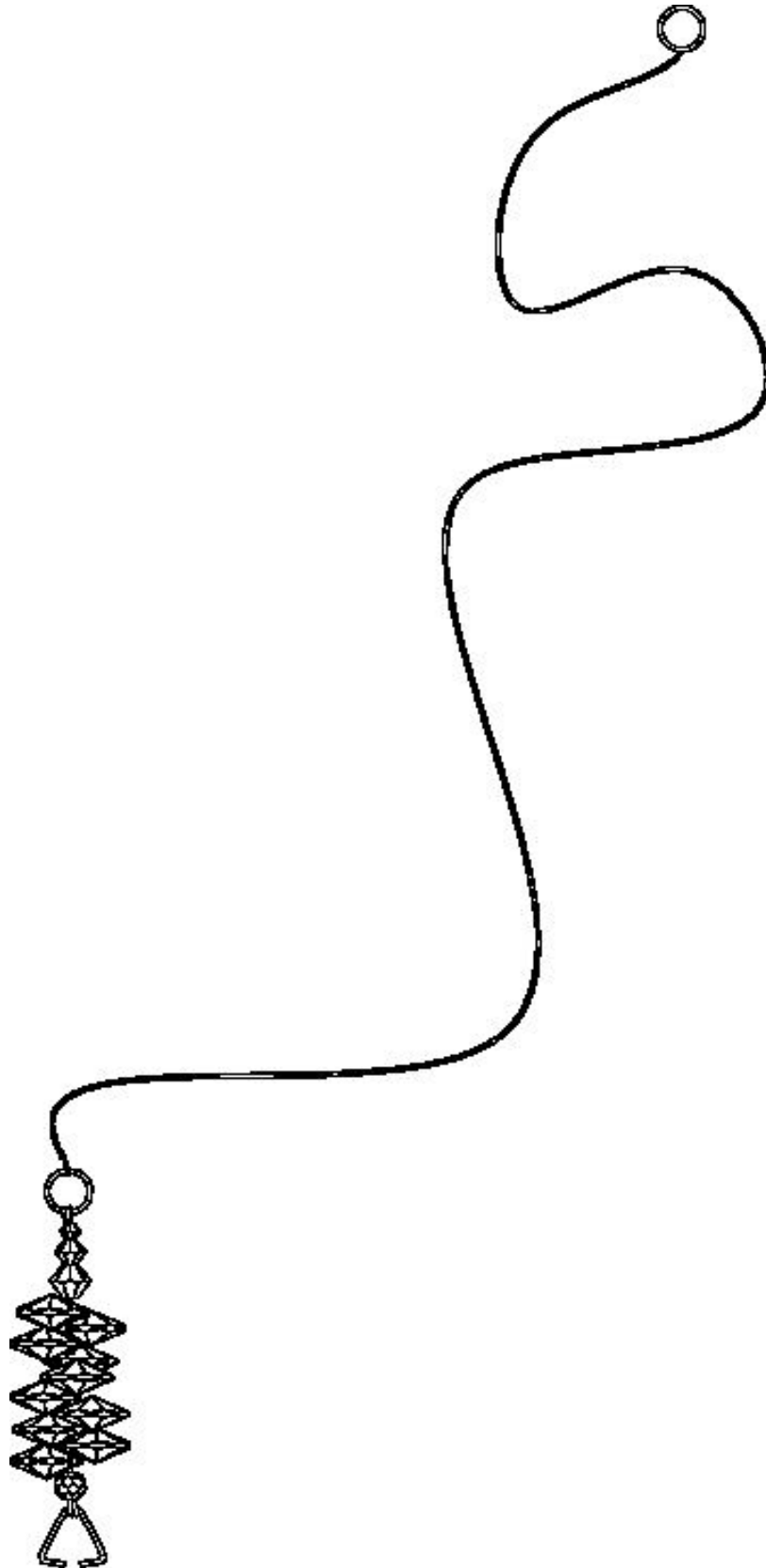

octagons: CRYSTAL CLEAR or MULTICOLOR (10 different colors)

EURO
piece

EURO
piece

EURO
piece

EURO
piece

EURO
piece

CASCADE ... PENDANTS

LOWER PART



D.1801 - CASCADE

BAG pieces

CRYSTAL CLEAR & CRYSTAL CLEAR
MULTICOLOR & CRYSTAL CLEAR

76 mm

1 (individually packed in plastic-bag)

4,7112
5,7562



D.1802 - CASCADE

BAG pieces

CRYSTAL CLEAR & CRYSTAL CLEAR
MULTICOLOR & CRYSTAL CLEAR

63 mm

1 (individually packed in plastic-bag)

5,2309
6,2759



D.1803 - CASCADE

BAG pieces

CRYSTAL CLEAR & CRYSTAL CLEAR
MULTICOLOR & CRYSTAL CLEAR

63 mm

1 (individually packed in plastic-bag)

4,4119
5,4569



D.1804 - CASCADE

BAG pieces

CRYSTAL CLEAR & CRYSTAL CLEAR
MULTICOLOR & CRYSTAL CLEAR

30 mm

1 (individually packed in plastic-bag)

4,5148
5,5598



D.1805 - CASCADE

BAG pieces

CRYSTAL CLEAR & CRYSTAL CLEAR
MULTICOLOR & CRYSTAL CLEAR

40 mm

1 (individually packed in plastic-bag)

4,5819
5,6269



D.1806 - CASCADE

BAG pieces

CRYSTAL CLEAR & CRYSTAL CLEAR
MULTICOLOR & CRYSTAL CLEAR

63 mm

1 (individually packed in plastic-bag)

5,3501
6,3951



D.1807 - CASCADE

BAG pieces

CRYSTAL CLEAR & CRYSTAL CLEAR
MULTICOLOR & CRYSTAL CLEAR

76 mm

1 (individually packed in plastic-bag)

6,1732
7,2182



D.1808 - CASCADE

BAG pieces

CRYSTAL CLEAR & CRYSTAL CLEAR
MULTICOLOR & CRYSTAL CLEAR

40 mm

1 (individually packed in plastic-bag)

5,3935
6,4385



D.1809 - CASCADE

BAG pieces

CRYSTAL CLEAR & CRYSTAL CLEAR
MULTICOLOR & CRYSTAL CLEAR

40 mm

1 (individually packed in plastic-bag)

7,2433
8,2883



D.1810 - CASCADE

BAG pieces

CRYSTAL CLEAR & CRYSTAL CLEAR
MULTICOLOR & CRYSTAL CLEAR

63 mm

1 (individually packed in plastic-bag)

4,6615
5,7065

EURO
pieceEURO
pieceEURO
pieceEURO
pieceEURO
piece**LOWER
PART****CASCADE ... PENDANTS****D.1811 - CASCADE****40 mm**

BAG pieces
CRYSTAL CLEAR & CRYSTAL CLEAR
MULTICOLOR & CRYSTAL CLEAR

1 (individually packed in plastic-bag)
5,1794
6,2244

**D.1812 - CASCADE****40 mm**

BAG pieces
CRYSTAL CLEAR & CRYSTAL CLEAR
MULTICOLOR & CRYSTAL CLEAR

1 (individually packed in plastic-bag)
4,4039
5,4489

**D.1813 - CASCADE****40 mm**

BAG pieces
CRYSTAL CLEAR & CRYSTAL CLEAR
MULTICOLOR & CRYSTAL CLEAR

1 (individually packed in plastic-bag)
4,3033
5,3483

**D.1814 - CASCADE****40 mm**

BAG pieces
CRYSTAL CLEAR & CRYSTAL CLEAR
MULTICOLOR & CRYSTAL CLEAR

1 (individually packed in plastic-bag)
5,6631
6,7081

**D.1815 - CASCADE****50 mm**

BAG pieces
CRYSTAL CLEAR & CRYSTAL CLEAR
MULTICOLOR & CRYSTAL CLEAR

1 (individually packed in plastic-bag)
4,6811
5,7261

**D.1816 - CASCADE****43 mm**

BAG pieces
CRYSTAL CLEAR & CRYSTAL CLEAR
MULTICOLOR & CRYSTAL CLEAR

1 (individually packed in plastic-bag)
5,9283
6,9733

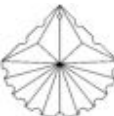
**D.1817 - CASCADE****50 mm**

BAG pieces
CRYSTAL CLEAR & CRYSTAL CLEAR
MULTICOLOR & CRYSTAL CLEAR

1 (individually packed in plastic-bag)
6,6091
7,6541

**D.1818 - CASCADE****45 mm**

BAG pieces
CRYSTAL CLEAR & CRYSTAL CLEAR
MULTICOLOR & CRYSTAL CLEAR

1 (individually packed in plastic-bag)
5,8500
6,8950

**D.1819 - CASCADE****50 mm**

BAG pieces
CRYSTAL CLEAR & CRYSTAL CLEAR
MULTICOLOR & CRYSTAL CLEAR

1 (individually packed in plastic-bag)
7,2028
8,2478

**D.1820 - CASCADE****50 mm**

BAG pieces
CRYSTAL CLEAR & CRYSTAL CLEAR
MULTICOLOR & CRYSTAL CLEAR

1 (individually packed in plastic-bag)
6,0018
7,0468

EURO
pieceEURO
pieceEURO
pieceEURO
pieceEURO
piece**LOWER
PART****CASCADE ... PENDANTS****D.1821 - CASCADE****45 mm**

BAG pieces
CRYSTAL CLEAR & CRYSTAL CLEAR
MULTICOLOR & CRYSTAL CLEAR

1 (individually packed in plastic-bag)
4,7460
5,7910

**D.1822 - CASCADE****40 mm**

BAG pieces
CRYSTAL CLEAR & CRYSTAL CLEAR
MULTICOLOR & CRYSTAL CLEAR

1 (individually packed in plastic-bag)
4,7696
5,8146

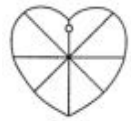
**D.1823 - CASCADE****40 mm**

BAG pieces
CRYSTAL CLEAR & CRYSTAL CLEAR
MULTICOLOR & CRYSTAL CLEAR

1 (individually packed in plastic-bag)
4,2982
5,3432

**D.1824 - CASCADE****50 mm**

BAG pieces
CRYSTAL CLEAR & CRYSTAL CLEAR
MULTICOLOR & CRYSTAL CLEAR

1 (individually packed in plastic-bag)
4,8385
5,8835

**D.1825 - CASCADE****50 mm**

BAG pieces
CRYSTAL CLEAR & CRYSTAL CLEAR
MULTICOLOR & CRYSTAL CLEAR

1 (individually packed in plastic-bag)
5,6222
6,6672

**D.1826 - CASCADE****50 mm**

BAG pieces
CRYSTAL CLEAR & CRYSTAL CLEAR
MULTICOLOR & CRYSTAL CLEAR

1 (individually packed in plastic-bag)
6,0018
7,0468

**D.1827 - CASCADE****40 mm**

BAG pieces
CRYSTAL CLEAR & CRYSTAL CLEAR
MULTICOLOR & CRYSTAL CLEAR

1 (individually packed in plastic-bag)
4,2982
5,3432

**D.1828 - CASCADE****40 mm**

BAG pieces
CRYSTAL CLEAR & CRYSTAL CLEAR
MULTICOLOR & CRYSTAL CLEAR

1 (individually packed in plastic-bag)
5,0759
6,1209

**D.1829 - CASCADE****63 mm**

BAG pieces
CRYSTAL CLEAR & CRYSTAL CLEAR
MULTICOLOR & CRYSTAL CLEAR

1 (individually packed in plastic-bag)
4,1418
5,1868

**D.1830 - CASCADE****50 mm**

BAG pieces
CRYSTAL CLEAR & CRYSTAL CLEAR
MULTICOLOR & CRYSTAL CLEAR

1 (individually packed in plastic-bag)
4,2323
5,2773

EURO
pieceEURO
pieceEURO
pieceEURO
pieceEURO
piece**LOWER
PART****CASCADE ... PENDANTS****D.1831 - CASCADE****50 mm**

BAG pieces
CRYSTAL CLEAR & CRYSTAL CLEAR
MULTICOLOR & CRYSTAL CLEAR

1 (individually packed in plastic-bag)
5,0090
6,0540

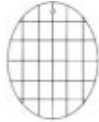
**D.1832 - CASCADE****50 mm**

BAG pieces
CRYSTAL CLEAR & CRYSTAL CLEAR
MULTICOLOR & CRYSTAL CLEAR

1 (individually packed in plastic-bag)
4,8718
5,9168

**D.1833 - CASCADE****45 mm**

BAG pieces
CRYSTAL CLEAR & CRYSTAL CLEAR
MULTICOLOR & CRYSTAL CLEAR

1 (individually packed in plastic-bag)
5,1608
6,2058

**D.1834 - CASCADE****63 mm**

BAG pieces
CRYSTAL CLEAR & CRYSTAL CLEAR
MULTICOLOR & CRYSTAL CLEAR

1 (individually packed in plastic-bag)
5,2952
6,3402

**D.1835 - CASCADE****63 mm**

BAG pieces
CRYSTAL CLEAR & CRYSTAL CLEAR
MULTICOLOR & CRYSTAL CLEAR

1 (individually packed in plastic-bag)
5,9346
6,9796

**D.1836 - CASCADE****63 mm**

BAG pieces
CRYSTAL CLEAR & CRYSTAL CLEAR
MULTICOLOR & CRYSTAL CLEAR

1 (individually packed in plastic-bag)
5,1492
6,1942

**D.1837 - CASCADE****63 mm**

BAG pieces
CRYSTAL CLEAR & CRYSTAL CLEAR
MULTICOLOR & CRYSTAL CLEAR

1 (individually packed in plastic-bag)
8,0589
9,1039

**D.1838 - CASCADE****63 mm**

BAG pieces
CRYSTAL CLEAR & CRYSTAL CLEAR
MULTICOLOR & CRYSTAL CLEAR

1 (individually packed in plastic-bag)
4,8265
5,8715

**D.1839 - CASCADE****63 mm**

BAG pieces
CRYSTAL CLEAR & CRYSTAL CLEAR
MULTICOLOR & CRYSTAL CLEAR

1 (individually packed in plastic-bag)
5,2835
6,3285

**D.1840 - CASCADE****63 mm**

BAG pieces
CRYSTAL CLEAR & CRYSTAL CLEAR
MULTICOLOR & CRYSTAL CLEAR

1 (individually packed in plastic-bag)
5,2952
6,3402

EURO
pieceEURO
pieceEURO
pieceEURO
pieceEURO
piece**LOWER
PART****CASCADE ... PENDANTS****D.1841 - CASCADE****50 mm**BAG pieces
CRYSTAL CLEAR & CRYSTAL CLEAR
MULTICOLOR & CRYSTAL CLEAR1 (individually packed in plastic-bag)
4,2781
5,3231**D.1842 - CASCADE****50 mm**BAG pieces
CRYSTAL CLEAR & CRYSTAL CLEAR
MULTICOLOR & CRYSTAL CLEAR1 (individually packed in plastic-bag)
4,0990
5,1440**D.1843 - CASCADE****50 mm**BAG pieces
CRYSTAL CLEAR & CRYSTAL CLEAR
MULTICOLOR & CRYSTAL CLEAR1 (individually packed in plastic-bag)
4,0990
5,1440**D.1844 - CASCADE****50 mm**BAG pieces
CRYSTAL CLEAR & CRYSTAL CLEAR
MULTICOLOR & CRYSTAL CLEAR1 (individually packed in plastic-bag)
4,1296
5,1746**D.1845 - CASCADE****50 mm**BAG pieces
CRYSTAL CLEAR & CRYSTAL CLEAR
MULTICOLOR & CRYSTAL CLEAR1 (individually packed in plastic-bag)
4,5436
5,5886**D.1846 - CASCADE****50 mm**BAG pieces
CRYSTAL CLEAR & CRYSTAL CLEAR
MULTICOLOR & CRYSTAL CLEAR1 (individually packed in plastic-bag)
4,2089
5,2539**D.1847 - CASCADE****50 mm**BAG pieces
CRYSTAL CLEAR & CRYSTAL CLEAR
MULTICOLOR & CRYSTAL CLEAR1 (individually packed in plastic-bag)
4,5991
5,6441**D.1848 - CASCADE****50 mm**BAG pieces
CRYSTAL CLEAR & CRYSTAL CLEAR
MULTICOLOR & CRYSTAL CLEAR1 (individually packed in plastic-bag)
4,9594
6,0044**D.1849 - CASCADE****50 mm**BAG pieces
CRYSTAL CLEAR & CRYSTAL CLEAR
MULTICOLOR & CRYSTAL CLEAR1 (individually packed in plastic-bag)
4,2089
5,2539**D.1850 - CASCADE****50 mm**BAG pieces
CRYSTAL CLEAR & CRYSTAL CLEAR
MULTICOLOR & CRYSTAL CLEAR1 (individually packed in plastic-bag)
4,9594
6,0044

EURO
piece

EURO
piece

EURO
piece

EURO
piece

EURO
piece

DREAMCATCHER ... PENDANTS

D.1891 - DREAMCATCHER

150 mm

BAG pieces

1

(individually packed in plastic-bag)

CRYSTAL CLEAR

15,8231

CHROME-frame
with
CLEAR crystals
(36x 14mm-octagons)

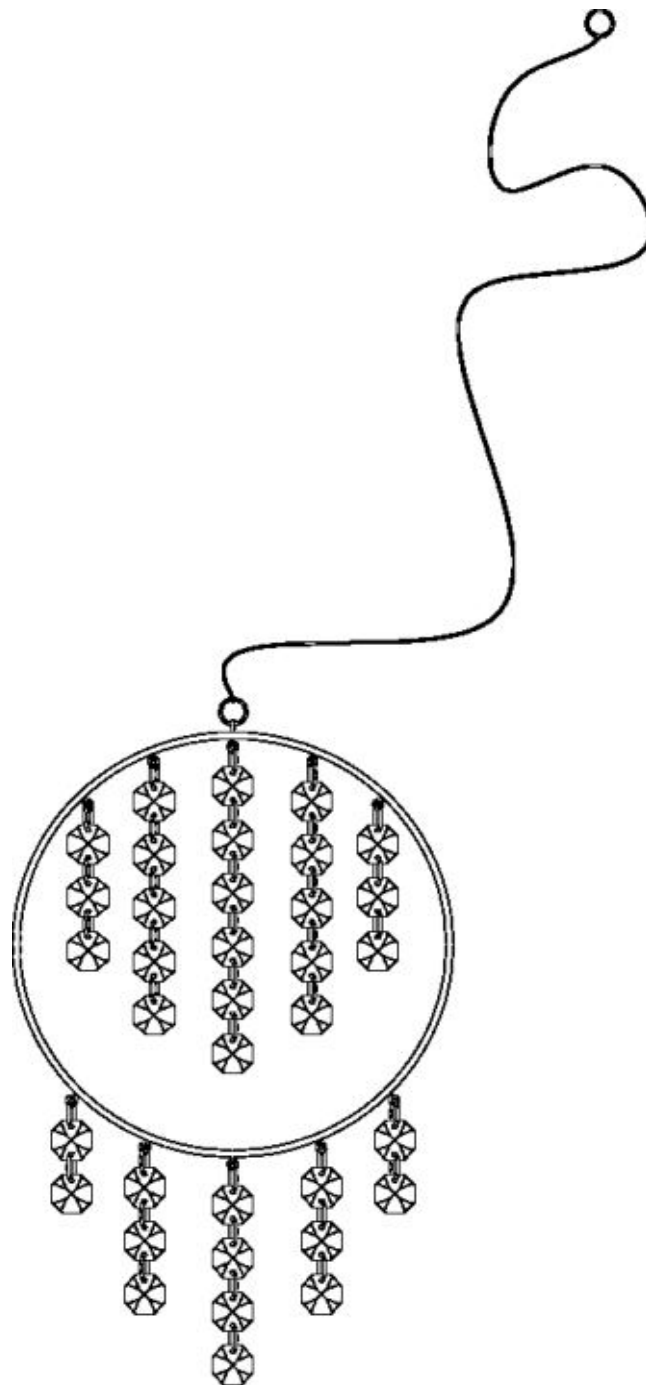

EURO
piece

EURO
piece

EURO
piece

EURO
piece

EURO
piece

DREAMCATCHER ... PENDANTS

D.1892 - DREAMCATCHER

200 mm

BAG pieces

1

(individually packed in plastic-bag)

CRYSTAL CLEAR

24,6544

CHROME-frame

with

CLEAR crystals

(72x 14mm-octagons)

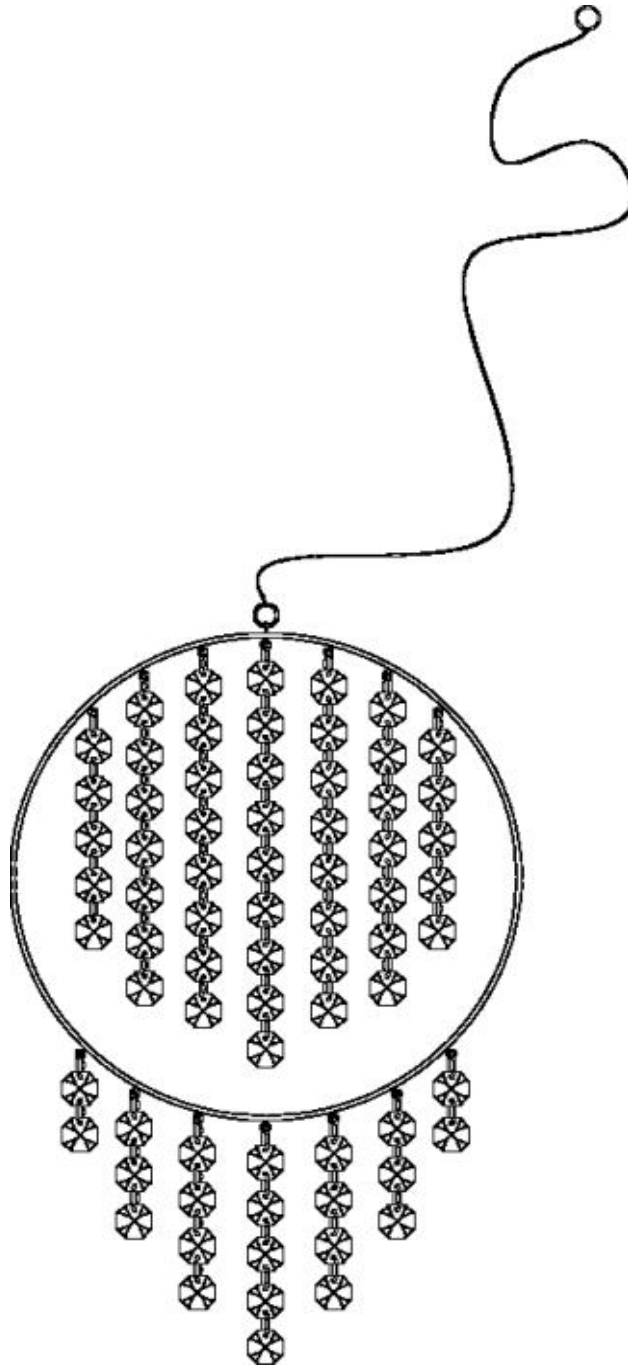

EURO
piece

EURO
piece

EURO
piece

EURO
piece

EURO
piece

WIND CHIME ... PENDANTS

D.1921 - WIND CHIME

100 x 160 mm

BAG pieces

1 (individually packed in plastic-bag)

CRYSTAL CLEAR & CRYSTAL CLEAR

10,7883

CRYSTAL CLEAR & MULTICOLOR

15,0868

(icicles: AQUAMARINE, center-chain: octagons AQUAMARINE+EMERALD, finial EMERALD)

(rim: 6 chains)

(center: 1 chain)

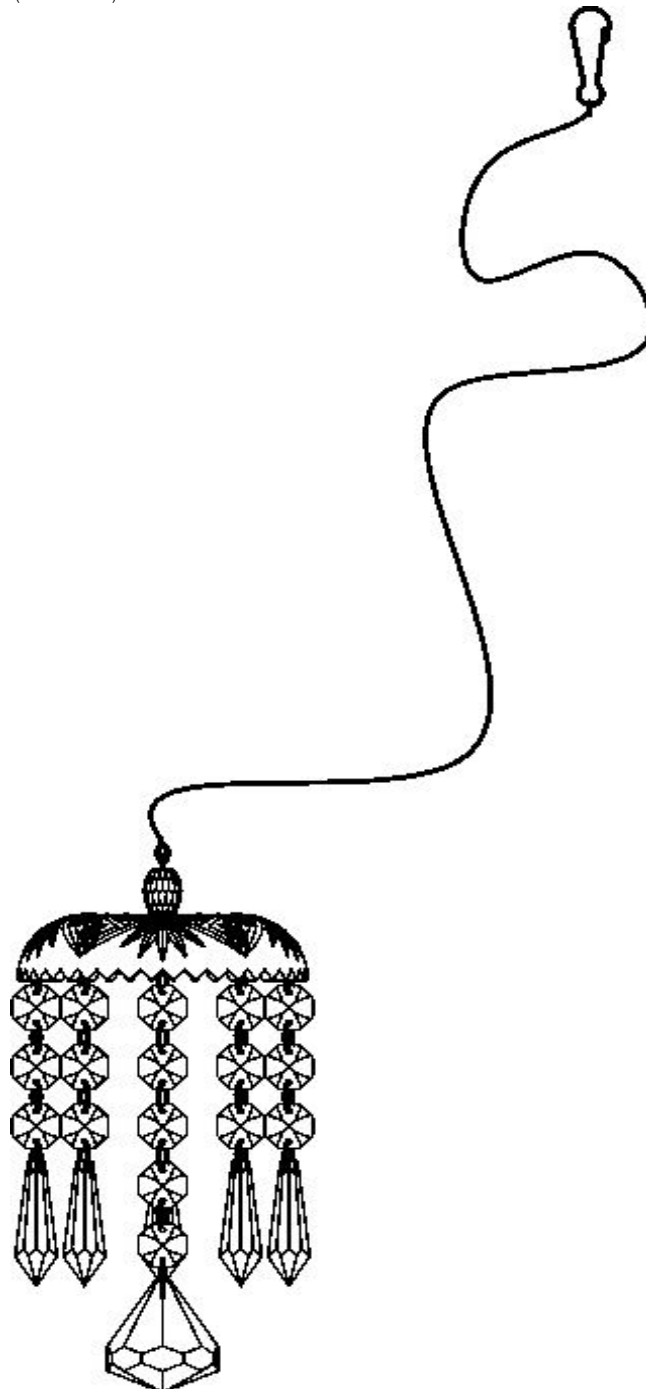

EURO
piece

EURO
piece

EURO
piece

EURO
piece

EURO
piece

WIND CHIME ... PENDANTS

D.1931 - WIND CHIME

120 x 220 mm

BAG pieces

1 (individually packed in plastic-bag)

CRYSTAL CLEAR & CRYSTAL CLEAR

12,6660

CRYSTAL CLEAR & MULTICOLOR

18,5587

(icicles: ROSALIN, center-chain: octagons ROSALIN+RUBY, heart RUBY)

(rim: 5 chains)

(center: 1 chain)

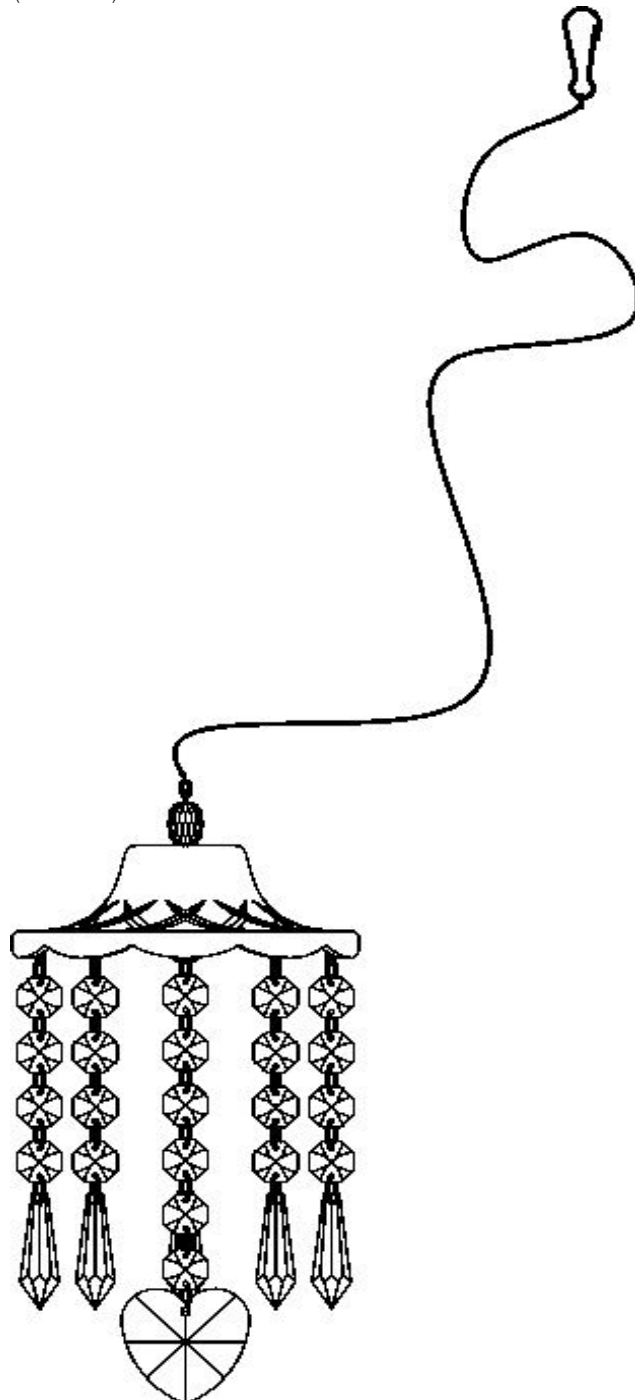

EURO
piece

EURO
piece

EURO
piece

EURO
piece

EURO
piece

FACETED ... BAG ... PENDANTS



D.3880 - BAG PENDANT "BALL"

BOX pieces

20 mm (individually packed)
50 (in poly-bag)

CRYSTAL CLEAR

2,3218

(suspension: plastic (black) & metal (chrome))



D.3881 - BAG PENDANT "OCTAGON"

BOX pieces

20 mm (individually packed)
50 (in poly-bag)

CRYSTAL CLEAR

2,3218

(suspension: plastic (black) & metal (chrome))



D.3882 - BAG PENDANT "ALMOND"

BOX pieces

38x22 mm (individually packed)
50 (in poly-bag)

CRYSTAL CLEAR

2,3218

(suspension: plastic (black) & metal (chrome))



D.3883 - BAG PENDANT "ICICLE"

BOX pieces

38x15 mm (individually packed)
50 (in poly-bag)

CRYSTAL CLEAR

2,3218

(suspension: plastic (black) & metal (chrome))



D.3880 to D.3883 - SET ... 1 piece of each motif :

(individually packed)
(in poly-bag)

CRYSTAL CLEAR

9,2873

(suspension: plastic (black) & metal (chrome))

| | | | | |
|---------------|---------------|---------------|---------------|---------------|
| EURO piece | EURO piece | EURO piece | EURO piece | EURO piece |
|---------------|---------------|---------------|---------------|---------------|

SEASONS ... BAG ... PENDANTS



D.4880 - BAG PENDANT "SPRING ... HEART"

BOX pieces

30 mm (individually packed)
50 (in poly-bag)

CRYSTAL CLEAR
RUBY

| | | |
|--------|--|--|
| 2,3218 | | |
| 3,1868 | | |

(suspension: plastic (black) & metal (chrome))



D.4881 - BAG PENDANT "SUMMER ... SUN"

BOX pieces

30 mm (individually packed)
50 (in poly-bag)

CRYSTAL CLEAR
TOPAZ

| | | |
|--------|--|--|
| 2,3218 | | |
| 3,1868 | | |

(suspension: plastic (black) & metal (chrome))



D.4882 - BAG PENDANT "AUTUMN ... LEAF"

BOX pieces

32x20 mm (individually packed)
50 (in poly-bag)

CRYSTAL CLEAR
EMERALD

| | | |
|--------|--|--|
| 2,3218 | | |
| 3,1868 | | |

(suspension: plastic (black) & metal (chrome))

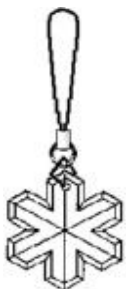

D.4883 - BAG PENDANT "WINTER ... SNOWFLAKE"

BOX pieces

30 mm (individually packed)
50 (in poly-bag)

CRYSTAL CLEAR
SAPPHIRE

| | | |
|--------|--|--|
| 2,3218 | | |
| 3,1868 | | |

(suspension: plastic (black) & metal (chrome))



D.4880 to D.4883 - SET ... 1 piece of each motif :

(individually packed)
(in poly-bag)

CRYSTAL CLEAR
COLORS

| | | |
|---------|--|--|
| 9,2873 | | |
| 12,7470 | | |

(suspension: plastic (black) & metal (chrome))

EURO
piece

EURO
piece

EURO
piece

EURO
piece

EURO
piece

FACETED ... KEYRINGS



D.3660 - KEYRING "BALL"

BOX pieces

20 mm (individually packed)
50 (in poly-bag)

CRYSTAL CLEAR

(keyring & chain: chrome)

2,7604



D.3661 - KEYRING "OCTAGON"

BOX pieces

20 mm (individually packed)
50 (in poly-bag)

CRYSTAL CLEAR

(keyring & chain: chrome)

2,7604



D.3662 - KEYRING "ALMOND"

BOX pieces

38x22 mm (individually packed)
50 (in poly-bag)

CRYSTAL CLEAR

(keyring & chain: chrome)

2,7604



D.3663 - KEYRING "ICICLE"

BOX pieces

38x15 mm (individually packed)
50 (in poly-bag)

CRYSTAL CLEAR

(keyring & chain: chrome)

2,7604

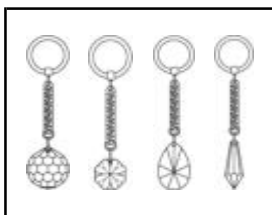

D.3660 to D.3663 - SET ... 1 piece of each motif :

CRYSTAL CLEAR

(keyring & chain: chrome)

11,0416

(individually packed)
(in poly-bag)

| | | | | |
|---------------|---------------|---------------|---------------|---------------|
| EURO piece | EURO piece | EURO piece | EURO piece | EURO piece |
|---------------|---------------|---------------|---------------|---------------|

SEASONS ... KEYRINGS



D.4660 - KEYRING "SPRING ... HEART"

BOX pieces

30 mm (individually packed)
50 (in poly-bag)

| | | | | |
|---------------|---------------------------|--------|--|--|
| CRYSTAL CLEAR | (keyring & chain: chrome) | 2,7604 | | |
| RUBY | (keyring & chain: chrome) | 3,6253 | | |

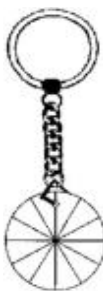

D.4661 - KEYRING "SUMMER ... SUN"

BOX pieces

30 mm (individually packed)
50 (in poly-bag)

| | | | | |
|---------------|---------------------------|--------|--|--|
| CRYSTAL CLEAR | (keyring & chain: chrome) | 2,7604 | | |
| TOPAZ | (keyring & chain: chrome) | 3,6253 | | |



D.4662 - KEYRING "AUTUMN ... LEAF"

BOX pieces

32x20 mm (individually packed)
50 (in poly-bag)

| | | | | |
|---------------|---------------------------|--------|--|--|
| CRYSTAL CLEAR | (keyring & chain: chrome) | 2,7604 | | |
| EMERALD | (keyring & chain: chrome) | 3,6253 | | |



D.4663 - KEYRING "WINTER ... SNOWFLAKE"

BOX pieces

30 mm (individually packed)
50 (in poly-bag)

| | | | | |
|---------------|---------------------------|--------|--|--|
| CRYSTAL CLEAR | (keyring & chain: chrome) | 2,7604 | | |
| SAPPHIRE | (keyring & chain: chrome) | 3,6253 | | |



D.4660 to D.4663 - SET ... 1 piece of each motif :

(individually packed)
(in poly-bag)

| | | | | |
|---------------|---------------------------|---------|--|--|
| CRYSTAL CLEAR | (keyring & chain: chrome) | 11,0416 | | |
| COLORS | (keyring & chain: chrome) | 14,5014 | | |

EURO
piece

EURO
piece

EURO
piece

EURO
piece

EURO
piece

FENGSHUI ... KEYRINGS



D.1403 - KEYRING "DOLPHIN"

BAG pieces

CRYSTAL FOILED (keyring & chain: chrome)

20 mm (individually packed)
1 (in poly-bag)

5,7785



D.1404 - KEYRING "YIN YANG"

BAG pieces

CRYSTAL FOILED (keyring & chain: chrome)

20 mm (individually packed)
1 (in poly-bag)

5,7785



D.1405 - KEYRING "CENTERMIRROR"

BAG pieces

CRYSTAL FOILED (keyring & chain: chrome)

20 mm (individually packed)
1 (in poly-bag)

5,7785



D.1406 - KEYRING "SUN"

BAG pieces

CRYSTAL FOILED (keyring & chain: chrome)

20 mm (individually packed)
1 (in poly-bag)

5,7785



D.1407 - KEYRING "MOON"

BAG pieces

CRYSTAL FOILED (keyring & chain: chrome)

20 mm (individually packed)
1 (in poly-bag)

5,7785



D.1408 - KEYRING "STAR"

BAG pieces

CRYSTAL FOILED (keyring & chain: chrome)

20 mm (individually packed)
1 (in poly-bag)

5,7785

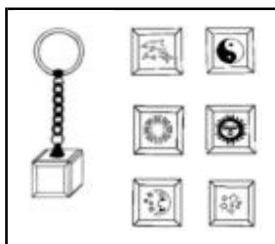

D.1403 to D.1408 - SET ... 1 piece of each motif :

CRYSTAL FOILED (keyring & chain: chrome)

(individually packed)
(in poly-bag)

34,6709

EURO
pieceEURO
pieceEURO
pieceEURO
pieceEURO
piece

ZODIAC ... KEYRINGS



D.1501 - KEYRING "CAPRICORN"

BAG pieces

20 mm (individually packed)
1 (in poly-bag)

CRYSTAL FOILED (keyring & chain: chrome)

5,7785



D.1502 - KEYRING "AQUARIUS"

BAG pieces

20 mm (individually packed)
1 (in poly-bag)

CRYSTAL FOILED (keyring & chain: chrome)

5,7785



D.1503 - KEYRING "PISCES"

BAG pieces

20 mm (individually packed)
1 (in poly-bag)

CRYSTAL FOILED (keyring & chain: chrome)

5,7785



D.1504 - KEYRING "ARIES"

BAG pieces

20 mm (individually packed)
1 (in poly-bag)

CRYSTAL FOILED (keyring & chain: chrome)

5,7785



D.1505 - KEYRING "TAURUS"

BAG pieces

20 mm (individually packed)
1 (in poly-bag)

CRYSTAL FOILED (keyring & chain: chrome)

5,7785



D.1506 - KEYRING "GEMINI"

BAG pieces

20 mm (individually packed)
1 (in poly-bag)

CRYSTAL FOILED (keyring & chain: chrome)

5,7785



D.1507 - KEYRING "CANCER"

BAG pieces

20 mm (individually packed)
1 (in poly-bag)

CRYSTAL FOILED (keyring & chain: chrome)

5,7785



D.1508 - KEYRING "LEO"

BAG pieces

20 mm (individually packed)
1 (in poly-bag)

CRYSTAL FOILED (keyring & chain: chrome)

5,7785



D.1509 - KEYRING "VIRGO"

BAG pieces

20 mm (individually packed)
1 (in poly-bag)

CRYSTAL FOILED (keyring & chain: chrome)

5,7785



D.1510 - KEYRING "LIBRA"

BAG pieces

20 mm (individually packed)
1 (in poly-bag)

CRYSTAL FOILED (keyring & chain: chrome)

5,7785



D.1511 - KEYRING "SCORPIO"

BAG pieces

20 mm (individually packed)
1 (in poly-bag)

CRYSTAL FOILED (keyring & chain: chrome)

5,7785



D.1512 - KEYRING "SAGITTARIUS"

BAG pieces

20 mm (individually packed)
1 (in poly-bag)

CRYSTAL FOILED (keyring & chain: chrome)

5,7785

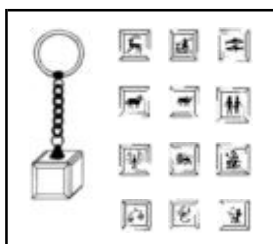

D.1501 to D.1512 - SET ... 1 piece of each motif :

(individually packed)
(in poly-bag)

CRYSTAL FOILED (keyring & chain: chrome)

69,3417

EURO
piece

EURO
piece

EURO
piece

EURO
piece

EURO
piece

CRYSTAL MEDAL

D.2611 - MEDAL

BAG pieces (individually packed in poly-bag)

CRYSTAL CLEAR + SAPPHIRE

(band color ... SAPPHIRE)

35 mm

1

5,6642

50 mm

1

7,6375

65 mm

1

10,3376

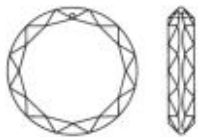

D.1100 - MEDAL WITHOUT BAND

BAG pieces (individually packed in poly-bag)

CRYSTAL CLEAR

35 mm

1

3,2331

50 mm

1

4,8117

65 mm

1

6,9718

EURO
piece

EURO
piece

EURO
piece

EURO
piece

EURO
piece

CRYSTAL TROPHY

D.2623 - TROPHY

BOX pieces

CRYSTAL CLEAR + SAPPHIRE

(base color ... SAPPHIRE)

60 mm

1

80 mm

1

100 mm

1

| 20,8972|

| 28,2780|

| 34,8906|

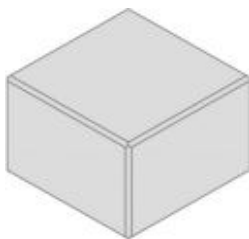
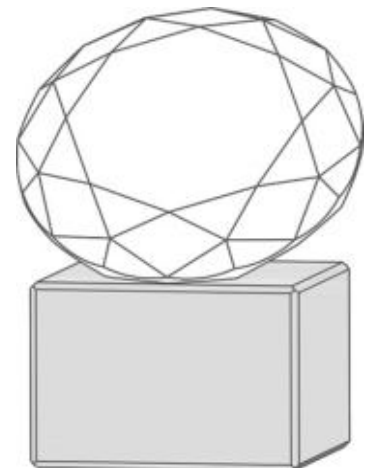
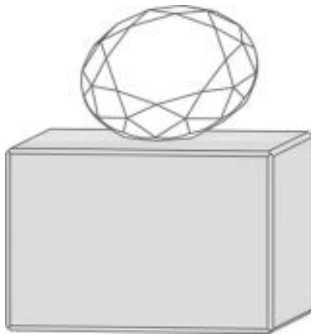

D.2300 - BASE

height:

BOX pieces

SAPPHIRE

75x75 mm

55 mm

1

| 15,2183|

EURO
piece

EURO
piece

EURO
piece

EURO
piece

EURO
piece



CRYSTAL CLEAR

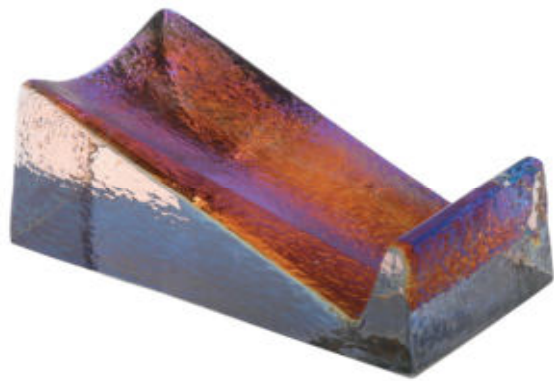

CRYSTAL BB

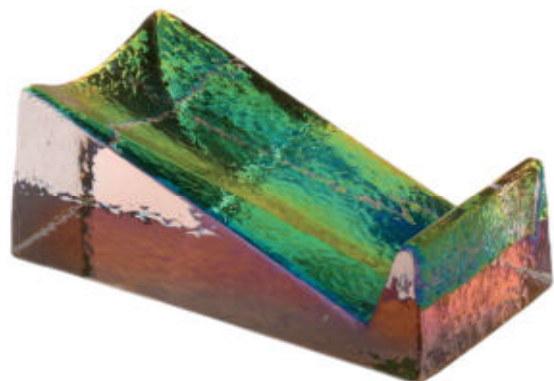

CRYSTAL VM

| | | | | |
|---------------|---------------|---------------|---------------|---------------|
| EURO piece | EURO piece | EURO piece | EURO piece | EURO piece |
|---------------|---------------|---------------|---------------|---------------|

CRYSTAL MOBILPHONE STAND



D.0711 - CRYSTAL MOBILPHONE STAND

BOX pieces

- CRYSTAL CLEAR
- CRYSTAL BB
- CRYSTAL VM

100x60mm

1

| |
|---------|
| 12,6263 |
| 24,1613 |
| 24,1613 |

EURO
piece

EURO
piece

EURO
piece

EURO
piece

EURO
piece

CRYSTAL CHRISTMAS TREE



D.1771



D.1772



D.1773



D.1774



D.1775



D.1776



D.1778



D.1779

EURO
piece

EURO
piece

EURO
piece

EURO
piece

EURO
piece

CRYSTAL CHRISTMAS TREE

| | <u>CHRISTMAS-TREE</u> | <u>115x75 mm</u> |
|----------------------|-------------------------------|-------------------------|
| | BOX pieces | 1 |
| <u>D.1771</u> | CRYSTAL CLEAR & CRYSTAL CLEAR | 34,8160 |
| <u>D.1772</u> | CRYSTAL CLEAR & CRYSTAL CLEAR | 34,8160 |
| <u>D.1773</u> | CRYSTAL CLEAR & MULTI-COLOR | 34,8160 |
| <u>D.1774</u> | CRYSTAL CLEAR & MULTI-COLOR | 34,8160 |
| <u>D.1775</u> | CRYSTAL CLEAR & MULTI-COLOR | 34,8160 |
| <u>D.1776</u> | CRYSTAL CLEAR & MULTI-COLOR | 34,8160 |

| | <u>CHRISTMAS-TREE</u> | <u>200x155 mm</u> |
|----------------------|------------------------------|--------------------------|
| | BOX pieces | 1 |
| <u>D.1778</u> | CRYSTAL CLEAR & MULTI-COLOR | 174,0802 |

| | <u>CHRISTMAS-TREE</u> | <u>275x225 mm</u> |
|----------------------|------------------------------|--------------------------|
| | BOX pieces | 1 |
| <u>D.1779</u> | CRYSTAL CLEAR & MULTI-COLOR | 249,0685 |

EURO
piece

EURO
piece

EURO
piece

EURO
piece

EURO
piece

CRYSTAL CHRISTMAS TREE



D.2960/1

375x250 mm

BOX pieces 1

CHROME-frame | 178,3340 |
with
CLEAR crystals

(20x 20mm-balls CLEAR)
(144x 14/16mm-octagons CLEAR)



D.2960/2

375x250 mm

BOX pieces 1

BROWN-frame | 231,2516 |
with
COLOR crystals

(20x 20mm-balls RUBY)
(144x 14/16mm-octagons EMERALD)



TABLEWARE



TABLEWARE

fine crystal

premium quality

mouth-blown & hand-made

contemporary straight glasses

individually packed in gift boxes

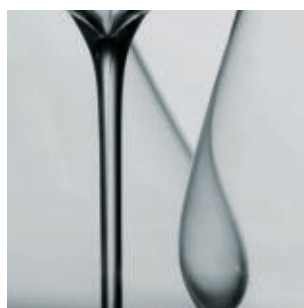

Schöler & Co. GmbH

Gablonzer Strasse 54-61
A-4550 Kremsmünster
Austria

T: ++43-75 83-77 23

F: ++43-75 83-78 12

E: office@scholer-crystal.at

W: www.scholer-crystal.at













ARTICLE INDEX

| Article: | Page: |
|-----------------|--------------|
| T.1005 | 9 |
| T.1015 | 10 |
| T.1025 | 11 |
| T.1035 | 12 |
| T.1045 | 13 |
| T.1055 | 14 |
| T.1065 | 15 |
| T.1075 | 16 |
| T.1085 | 17 |
| T.1095 | 18 |

PRODUCT GROUP

Page:

| | | |
|------------|---|----|
| DECANTER |  | 9 |
| WHITE WINE |  | 10 |
| RED WINE |  | 11 |
| CHAMPAGNE |  | 12 |
| BRANDY |  | 13 |
| LIQUEUR |  | 14 |
| BEER |  | 15 |
| WHISKEY |  | 16 |
| WATER |  | 17 |
| VASE |  | 18 |

edition PURE

... mouth-blown

... hand-made

... fine lead-free crystal

... premium sparkling quality

... individually packed in gift boxes

Each piece is a unique work of art,

**guaranteed by our  logo,
engraved at the bottom of each piece.**

**As our glasses have a master-blown thin edge,
washing by hand is recommended.**

**Since 1949, Schöler Crystal
has created the finest crystal with superior sparkle
for lighting, for interior, for decoration, etc.**

**Our long experience in crystal manufacturing
has encouraged the production of such a great tableware line.**

| | | |
|-------------------|-------------------|----------------------|
| CRYSTAL | minimum quantity | |
| CLEAR | | |
| EURO piece | BOX pieces | CARTON pieces |

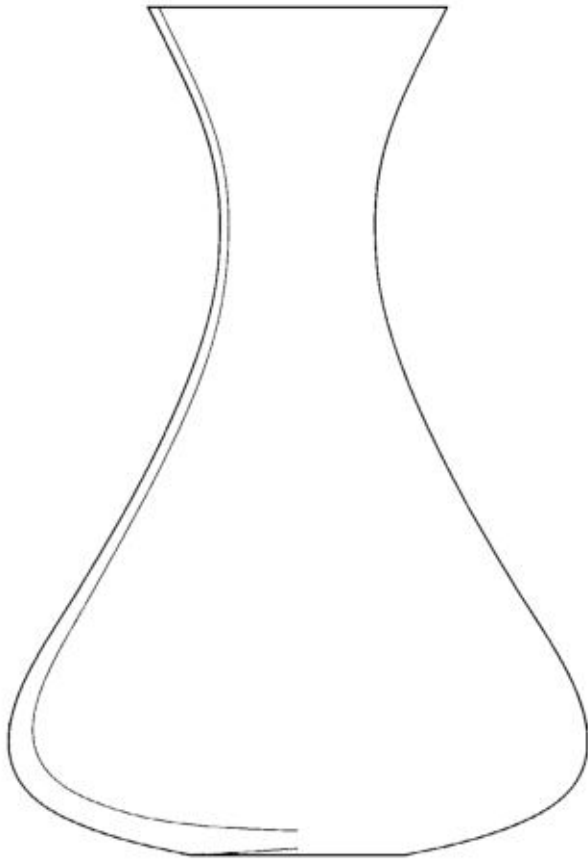

T.1005

270x160 mm

43,6851

1

4

DECANTER

1500 ml

- * mouth-blown
- * hand-made
- * fine lead-free crystal

| | | |
|-------------------|-------------------|----------------------|
| CRYSTAL | minimum quantity | |
| CLEAR | | |
| EURO piece | BOX pieces | CARTON pieces |

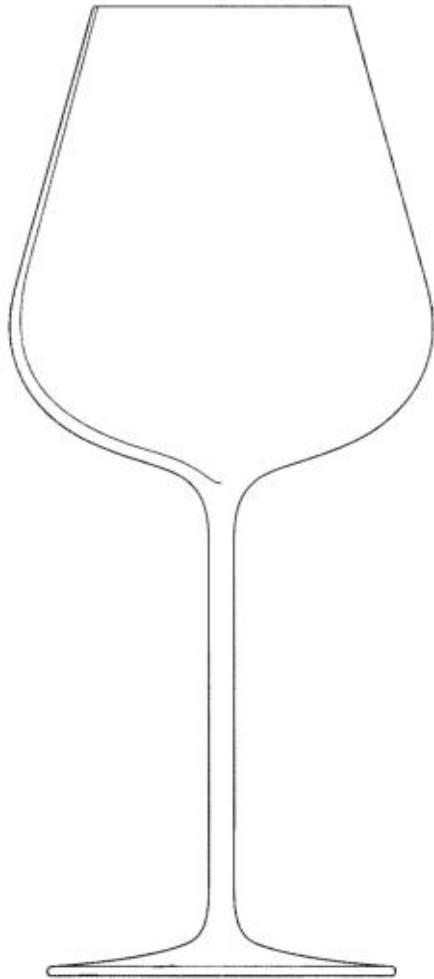

T.1015

209x86 mm | 22,1478 | 1 | 9

WHITE WINE

350 ml

- * mouth-blown
- * hand-made
- * fine lead-free crystal

| | | |
|-------------------|-------------------|----------------------|
| CRYSTAL | minimum quantity | |
| CLEAR | | |
| EURO piece | BOX pieces | CARTON pieces |

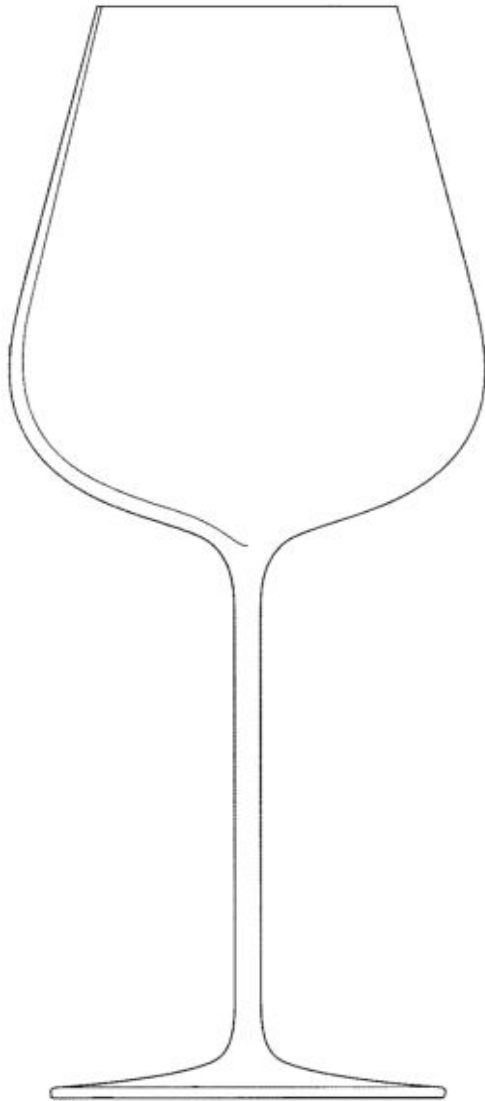

T.1025

229x94 mm

24,9739

1

9

RED WINE

450 ml

- * mouth-blown
- * hand-made
- * fine lead-free crystal

| | | |
|-------------------|-------------------|----------------------|
| CRYSTAL | minimum quantity | |
| CLEAR | | |
| EURO piece | BOX pieces | CARTON pieces |

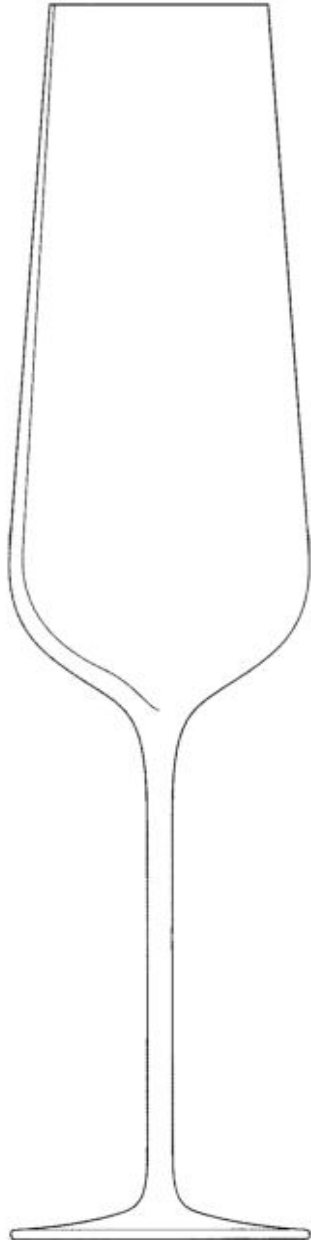

T.1035

266x60 mm

23,2217

1

9

CHAMPAGNE

250 ml

- * mouth-blown
- * hand-made
- * fine lead-free crystal

| | | |
|-------------------|-------------------|----------------------|
| CRYSTAL | minimum quantity | |
| CLEAR | | |
| EURO piece | BOX pieces | CARTON pieces |

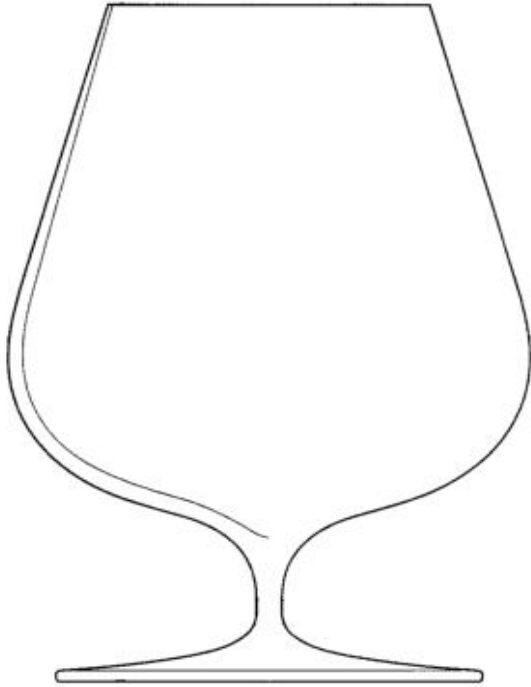

T.1045

136x99 mm

19,3783

1

9

BRANDY

450 ml

- * mouth-blown
- * hand-made
- * fine lead-free crystal

| CRYSTAL | minimum quantity | |
|------------|------------------|---------------|
| CLEAR | | |
| EURO piece | BOX pieces | CARTON pieces |



T.1055

177x48 mm | 17,4566 | 1 9

LIQUEUR

75 ml

- * mouth-blown
- * hand-made
- * fine lead-free crystal

| | | |
|-------------------|-------------------|----------------------|
| CRYSTAL | minimum quantity | |
| CLEAR | | |
| EURO piece | BOX pieces | CARTON pieces |

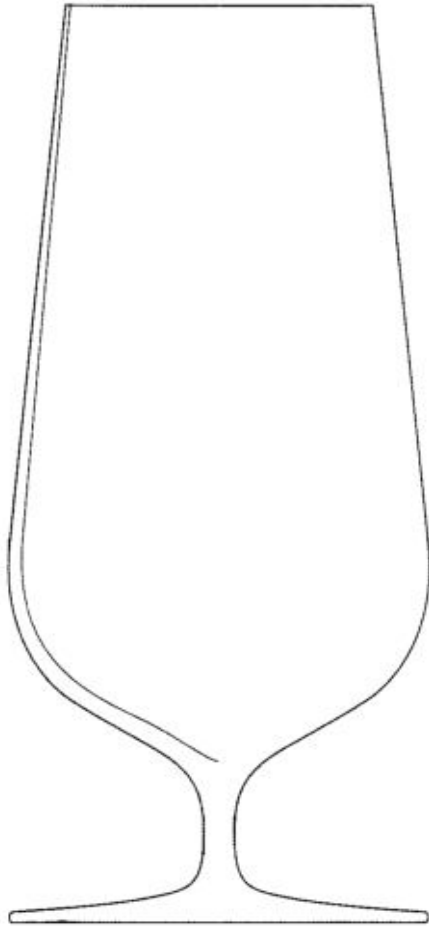

T.1065

171x74 mm | 20,4899 | 1 9

BEER

375 ml

- * mouth-blown
- * hand-made
- * fine lead-free crystal

| CRYSTAL | minimum quantity | |
|------------|------------------|---------------|
| CLEAR | | |
| EURO piece | BOX pieces | CARTON pieces |



T.1075

91x91 mm

13,4436

1

9

WHISKEY

350 ml

- * mouth-blown
- * hand-made
- * fine lead-free crystal

| CRYSTAL | minimum quantity | |
|------------|------------------|---------------|
| CLEAR | | |
| EURO piece | BOX pieces | CARTON pieces |

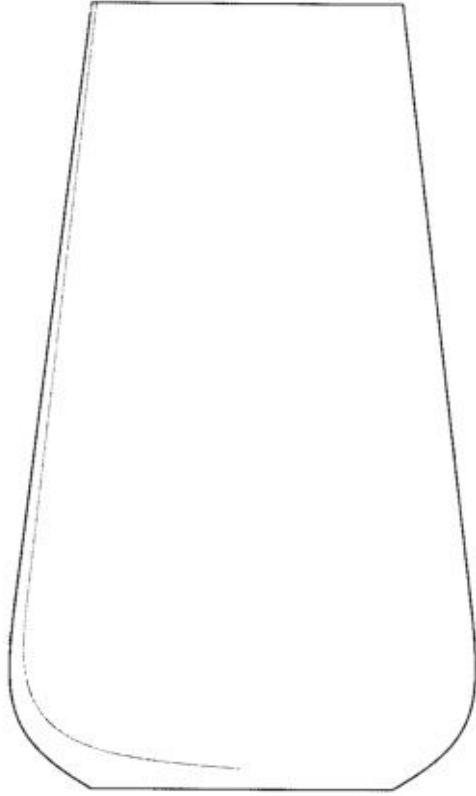

T.1085

146x82 mm

14,7436

1

9

WATER

450 ml

- * mouth-blown
- * hand-made
- * fine lead-free crystal

| | | |
|-------------------|-------------------|----------------------|
| CRYSTAL | minimum quantity | |
| CLEAR | | |
| EURO piece | BOX pieces | CARTON pieces |

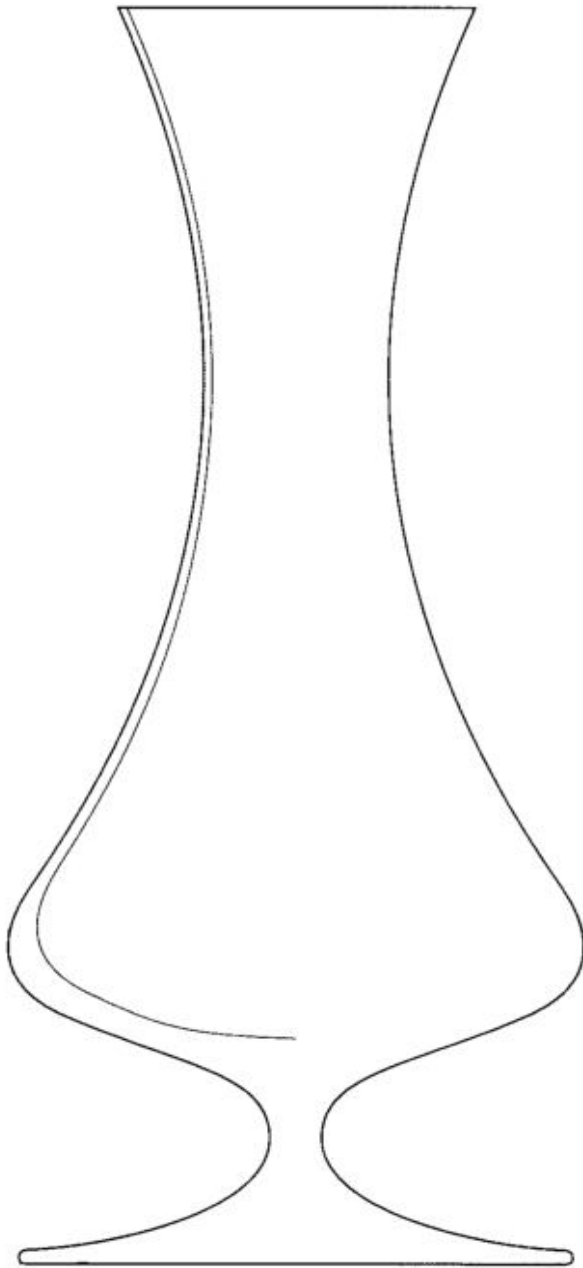

T.1095

301x130 mm

45,0981

1

4

VASE

900 ml

- * mouth-blown
- * hand-made
- * fine lead-free crystal

Schöler & Co. GmbH

Gablonzer Strasse 54-61
A-4550 Kremsmünster
Austria

T: ++43-75 83-77 23

F: ++43-75 83-78 12

E: office@scholer-crystal.at

W: www.scholer-crystal.at

